

# AQUA

AQUA

# AQUA

# MRV

Air Conditioning

## AQUA Air Conditioning

### ADDRESS

#### Ho Chi Minh Office:

Add: 17<sup>th</sup> Floor – Sonatus Building, No. 15 Le Thanh Ton Street, District 1, HCMC

#### Ha Noi Office:

Add: 16<sup>th</sup> Floor – Detech II Building, No. 107 Nguyen Phong Sac Street, Cau Giay District, HNC

#### Da Nang Office:

Add: 9<sup>th</sup> Floor – Post Office Building, No. 271 Nguyen Van Linh Street, Vinh Trung Ward, Thanh Khe District, DNC

### CONTACTS

Website: [www.aquavietnam.com.vn](http://www.aquavietnam.com.vn)

Hotline: 1800-585-832

**1** The specifications, design and information in this brochure are subject to the actual products. Haier reserves the right to make change without any notice.

Dec. 2022

Version 1.0

MRV

AQUA Air Conditioning

# AQUA—Haier Brand Story

Born in the country of "the rising sun", AQUA brand has been associated with the mission of improving the quality of life of users, through continuous improvement efforts to create the most exquisite products. In 1996, AQUA brought that mission to Vietnam with the name SANYO HA ASEAN - the number 1 prestigious household electrical brand voted by GFK in 2001. Up to now, AQUA Vietnam has been present in the lives of more than half of Vietnamese families with 1.5 million products.

In 2011, Haier Group acquired Sanyo business, including research and development (R&D) center, factory, sales company, 7000 employees, 1151 intellectual properties, and AQUA brand - a sub-brand of Sanyo washing machine brand. In 2012, Haier officially launched the AQUA brand in Japan. Since 2014, AQUA has been present in Vietnam, replacing the name Sanyo and officially starting the journey named AQUA Vietnam.

In 2015, Haier Asia's R&D center was built in Japan, one of the largest R&D centers among foreign companies in Japan, with an investment capital of more than 7 billion yen. Here, AQUA has launched exquisite products with advanced technology and top quality.

Established in 1984, Haier Group is a world-leading provider of a better life and digital transformation solutions.

With users at the center of all we do, we have deployed 10 R&D centers, 71 research institutes, 33 industrial parks, 133 manufacturing centers and more than 230,000 sales networks worldwide. We are the world's only IoT Ecosystem brand that has been ranked on the list of BrandZ Top 100 Most Valuable Global Brands for four years straight and topped Global Major Appliances Brand Rankings by Euromonitor International for 13 consecutive years. In 2021, our global revenue reached USD 52.2 billion, and our brand value reached USD 74.3 billion.

We own three listed companies. Our subsidiary Haier Smart Home is among the list of Fortune Global 500 and Fortune World's Most Admired Companies. We own seven global high-end brands, namely Haier, Casarte, Leader, GE Appliances, Fisher & Paykel, AQUA and Candy, and the world's first smart home scenario brand - THREE WINGED BIRD. In addition, we have built the world's leading Industrial Internet platform COSMOPlat and the great healthcare brand Yingqiang Healthcare. Our entrepreneurship acceleration platform HCH has successfully incubated 7 unicorn companies, 102 gazelle companies, and 80 specialized and sophisticated enterprises.

As a representative of the real economy, we have been constantly focusing on the industry and develop businesses in smart home and living, Industrial Internet, and great healthcare sectors; and have been building high-end, scenario and ecosystem brands. Through technological innovation, we aim to customize a personalized smart living experience for global users, help corporate clients with digital transformation, and promote high-quality and sustainable economic and social development.



# AQUA-Haier Global Network

Haier has owned 10+N R&D centers, 35 industrial park, 138 factories, 108 marketing centers across the world, and the sales network over 200 countries or regions.

Haier has seven major household appliance brands across the world: Haier, Casarte, Leader, AQUA, Fisher & Paykel, GE Appliances (GEA) and CANDY. All these brands together have constituted Haier's global brand cluster, which can fully meet the best experience of different consumer groups in different regions all across the world.

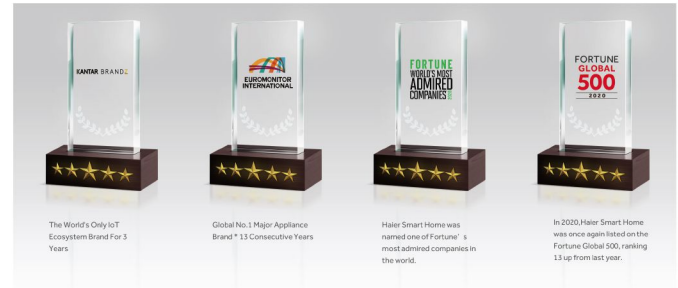

Candy Turkey Factory



Candy Italy Factory



Haier Refrigerator Factory in Romania



Haier Russia Smart Ecosystem Industrial Park



Haier R&D Center

Haier IoT Laundry Factory

**200+** Countries or Regions  
**10+N** R&D Centers  
**35** Industrial Parks  
**138** Manufacturing Centers  
**108** Marketing Centers

**CAFÉ**  
 Profile of Appliances  
**Haier Hotpoint**  
 North America

**Haier**  
 CANDY  
 Europe

**Casarte Haier**  
 FISHER & PAYKEL GE APPLIANCES  
 CANDY AQUA LEADER  
 China

**AQUA Haier**  
 Japan



Haier Pakistan Economic Zone

**Haier**  
 CANDY  
 South Asia



Haier Thailand Factory

Haier Indonesia Factory

**Haier**  
 CANDY  
 Middle East & Africa

**Haier**  
 AQUA  
 CANDY  
 Southeast Asia



Haier India Pune Industrial Park

Haier India Greater Noida Industrial Park

**Haier**  
 GE APPLIANCES  
 Latin America

**FISHER & PAYKEL**  
**Haier**  
 Australasia



GE Appliance Park, Louisville, U.S.



Haier Nigeria Factory



Haier AC Factory in Egypt



FISHER & PAYKEL New Zealand R&D Center



AQUA Vietnam Factory

# AQUA-Haier

## Global Manufacturing Capacity

In China, Haier owns 8 air conditioner factories, 1 of which is MHAQ, a JV between Haier and Mitsubishi Heavy. Besides China, Haier runs another 8 overseas air conditioner factories. These factories have a total production capacity of over 27.2 million units per year.



## The First Batch of Chinese Local Enterprise Selected as "Lighthouse Factory" in the World



# AQUA-Haier R&D Center

Haier Air Conditioning R&D Center, located in Qingdao, China, completed in December 2013, covers 20,000 square meters. It has more than 120 laboratories, including testing laboratories, key part research laboratories and all-weather user experience simulation laboratories. The R&D center also has the world tallest "drop tower" for testing long refrigerant piping tests (106 meters tall).

In April 2014, Haier established joint laboratories with Highly for research in heating & cooling technology and with Mitsubishi Electric for innovative technology for user experience. Research by the user experience center covers the fields of user comfort evaluation, aerodynamics, acoustics, EMC (Electro-Magnetic Compatibility) and mechanics etc. The labs can carry out more than 600 international tests as per ISO, IEC, EN, CISPR and ANSI etc. to meet the requirements of Europe, Asia, America, Australia, Middle East and other 100 countries and regions.

The user experience center gains recognition by domestic well-known certification and testing institutions, also is recognized by international organizations like TUV and Intertek etc. At Haier, we believe that the best air conditioning is one that builds on uncompromising quality control worldwide, developing and manufacturing fine products and delivering them to customers everywhere.



Haier & Mitsubishi  
Joint Laboratory



Haier & HIGHLY  
Joint Laboratory

## R&D Labs



EMC Test Lab



Water-spray  
Test Lab



Psychrometric  
Test Lab



Safety Test Lab



Full-anechoic  
Test Lab



Centralized Control  
Test Lab



Simulated Snow  
Test Lab



Simulated  
Sunshine Test Lab



Environmental  
Evaluation Test Lab



Humidity  
Evaluation Test Lab



Double 85  
Test Lab



Height Drop  
Test Lab

## Global Certification



# AQUA—Haier MRV Milestone

Haier AC has been holding No.1 market share in Pakistan for 5 consecutive years from 2009.

Haier AC was ranked NO.5 in Italy by market share in volume in 2012 & 2013 by DATABANK.

Haier B2C website in Italy was awarded "Interactive Key Award 2013".

Haier AC entered Winter Olympics in Sochi Russia in 2013.

1996

**Home VRF** (Home MRV)  
First unit in China Haier first home inverter multi

2005

**Modular combination MRV II**  
First pure DC inverter in China Technology from Toshiba

2012

**MRV 5** Full DC inverter Side discharge outdoor Largest capacity of side discharge

2014

**MRV IV** Full DC inverter, Large single module

2016

**MRV VIII PLUS** Full DC inverter  
**MRV SII** New platform, new outlook

2018

**MRV 5-RC** Launching MRV 5-RC heat recovery range

2020

**MRV 5-H** Launched MRV 5-H

2021

**MRV 5-C** launched Cooling only series

1993

**Haier** Enter into China commercial AC field

1999

**Commercial VRF** (C-MRV ) First Modular VRF unit in China

2008

**MRV III DC Inverter**  
23 Olympic reference projects in Beijing

2013

**MRV III-RC** Heat recovery (3 pipe system)

**MRV W**  
Water-cooled / MRV

2015

**MRV IV (T3)**  
Full DC inverter

2017

**MRV SII Launched Globally** including the first ever Haier MRV product for the north american market

2019

**US MRV 5** launched US MRV 5 HP & HR AHRI certification High efficiency and low operating temperature



# CONTENTS



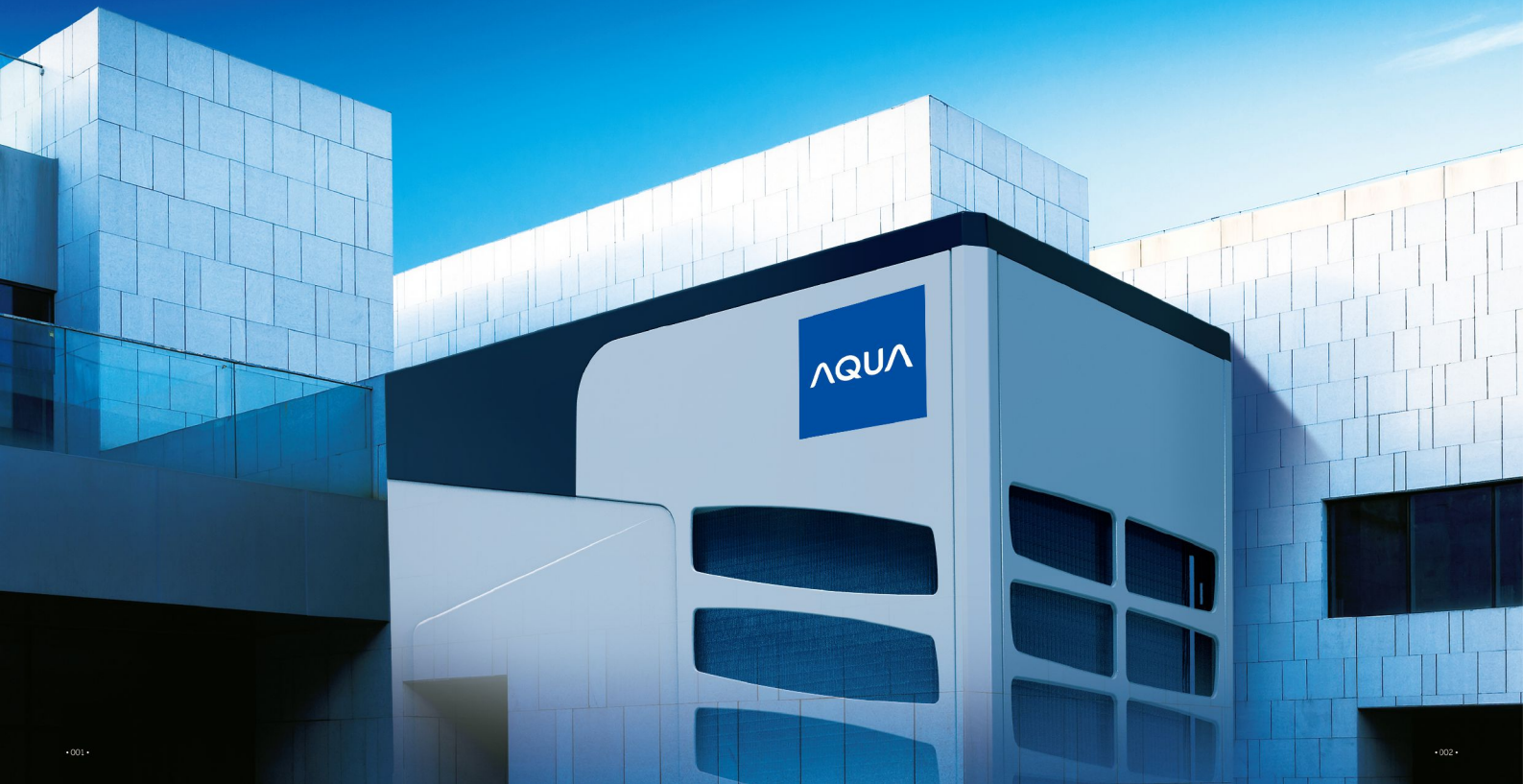

- 003** PRODUCT LINE UP
- 009** MRV 5
- 053** MRV 5-C
- 077** MRV SII
- 089** EASY MRV CONNECTION KIT
- 095** MRV AHU CONNECTION KIT
- 101** MRV INDOOR(Air Guard)
- 109** MRV INDOOR
- 185** CONTROL SYSTEM
- 203** REFERENCE PROJECTS











# PRODUCT LINE-UP

Outdoor Units













Series	HP	3	4	5	6	7	8	10	12	14	16	18	20	22	24	26	28	30	32	34	36	
<b>MRV SII</b>	1/220-240/50/60																					
	1/220-240/50/60																					
	3/380-415/50/60																					
	3/380-415/50/60																					

MODEL	EASY MRV			DX AHU <sup>+</sup> Connection kit					
	MS1-036A	MS1-060A	MS3-036A	Model	AH1-070B	AH1-140B	AH1-280B	AH1-560B	AH1-730B
Match with indoor	1 by 1	1 by 1	1 by 3	Capacity	3.5x≤7kW	7<x≤14kW	14<x≤28kW	28<x≤56kW	56<x≤73kW
<b>EASY MRV Connection Kit</b>									
Capacity(Btu/h)	≤36K	36K<X≤60K	Every indoor capacity ≤36K						
MRV series	MRV 5, MRV SII (4/5/6/8/10/12HP Double fan)			MRV series	MRV 5, MRV SII (4/5/6/8/10/12HP Double fan)				

# PRODUCT LINE-UP

Indoor Units

Series	KBTU/h kW	Model	5	7	9	12	16	18	24	28	30	38	42	48	54	72	96	
			1.5	2.2	2.8	3.6	4.5	5.6	7.1	8.0	9.0	11.2	12.5	14.0	16.0	22.6	28.0	
1-Way Cassette		AB**2MAERA	■	■	■	■												
		 AB**2MAERAD	■	■	■	■	■	■	■									
2-Way Cassette		AB**2MBERAD		■	■	■	■	■	■	■	■	■		■				
																		
Compact Cassette		AB**2MCERA(M)	■	■	■	■	■	■										
Round Way Cassette		AB**2MRERA		■	■	■	■	■	■	■	■	■		■	■			
4-Way Cassette		AB**2MCERA	■	■	■	■	■	■	■	■	■	■		■				
		AB**2MNERA																
Convertible		AC**2MDERA				■	■	■	■	■	■	■		■				
Slim Duct (0/15/30Pa) (Air Guard)		AD**2MSERA(H)	■	■	■	■	■	■	■									
Slim Duct (0/15/30Pa)		AD**2MSERA(D)	■	■	■	■	■	■	■									
		AD**2MSERA																
High ESP Duct (20/200Pa) (Air Guard)		AD**2MJERA(H)	■	■	■	■	■	■	■	■	■	■		■	■			

# PRODUCT LINE-UP

Indoor Units

Series	KBTU/h kW		5	7	9	12	16	18	24	28	30	38	42	48	54	72	96
			1.5	2.2	2.8	3.6	4.5	5.6	7.1	8.0	9.0	11.2	12.5	14.0	16.0	22.6	28.0
Medium ESP Duct (50/150Pa)		AD**2MJERAB AD**2MJERA	■	■	■	■	■	■	■	■	■	■		■	■		
High ESP Duct(20/200Pa)		AD**2MJERAD	■	■	■	■	■	■	■	■	■	■		■	■		
Compact Air Duct(50/120)		AD**2MJERN									■	■		■			
High ESP Duct (100/250Pa)		AD**2MTERAB														■	■
High ESP Duct (0-300Pa)		AD**2MTERAD														■	■
Built-in Floor Standing		AE**2MLERA		■	■	■	■	■	■								
Console		AF**2MBERA	■	■	■	■	■	■									
High Wall		AS**2MNERAB AS**2MNERA AS**2MNERAC (NEW)	■	■	■	■	■	■	■	■	■						
		AS**2MFERAB AS**2MFERA AS**2MFERAC (NEW)	■	■	■	■	■	■	■								
		AD**2MJERAF AD**2MTERAF												■	■	■	
Fresh Air Duct (Coming soon)																	
HRV (Heat Reclaim Ventilation) ERV**B1NW		150m <sup>3</sup> /h 500m <sup>3</sup> /h 2000m <sup>3</sup> /h 250m <sup>3</sup> /h 800m <sup>3</sup> /h 350m <sup>3</sup> /h 1000m <sup>3</sup> /h															



# MRV5

DC INVERTER

**011** Features & Benefits

**017** MRV 5 Outdoor

**031** Dimensions



# MVRV DC INVERTER

- Advanced Technology
- High Efficiency
- Super Comfort
- Easy Installation

## Smart

Wireless connection and communication between indoor units.

- Labor saving
- Automatic network connection
- Convenient maintenance
- Stable performance
- Total cost saving is about 30%



## Smart

### Cloud service

Through the internet cloud service protocol module, the operating data of MVRV can be collected to the cloud service center via 4G and ethernet, thereby achieving remote monitoring, fault alarm, energy consumption analysis and historical error.

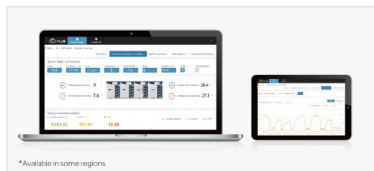

\* Available in some regions.

#### Fault alarm

During operating, real-time prediction can be made according to the operation condition of the unit, and early alarm will be given for possible faults.

#### Energy consumption statistics

The bar chart shows the statistics of power consumption in the last seven days, you can query the data in the last 30 days and one year.

#### Historical error

When some errors occur, installers can check the error records, including the fault time and reason, and quickly give response.

#### Remote monitoring

AQUA intelligent cloud service realizes remote real-time monitoring of unit operation data, including instantaneous load and power input/IDU operating state and so on.

In addition, all the above function can be used via the smart APP. It's more convenient.



## ADVANCED TECHNOLOGY

### Building automation system

The Modbus and BACnet communication modules are provided for the seamless connection with building automation system.

### Total pipe length 1000m, height drop 110m

- Max. total pipe length 1000m
- Max. actual pipe length 220m
- Max. equivalent pipe length 260m
- Max. drop between IDU&ODU / 90m (outdoor unit up) / 110m (outdoor unit down)
- Max. drop between IDU&IDU 30m\*

\* If the total pipe length is between 300m and 1100m or the drop between IDU and ODU more than 50m, please contact your local dealer.



Allowable pipe length and height difference between indoor and outdoor outdoor unit (outdoor unit above)

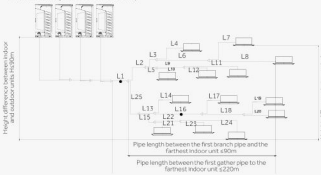

Pipe length and height difference (m)	Allowable value	For example
Single way total pipe length	1000	L1+L2+L3+L4+L5+L6+L7+L8+L9+L10+L11+L12+L13+L14+L15
Pipe length between the first gather pipe and the farthest indoor unit	220**	L1+L2+L3+L4+L5
Equivalent length	260	L1
Pipe length between the first gather pipe and the farthest indoor unit	4130	L1+L4+L12
Pipe length difference between the nearest indoor unit and the farthest indoor unit	140**	L4+L7+L8+L9+L10+L11+L12+L13+L14+L15
Pipe length difference between the nearest indoor unit and the farthest indoor unit	140	L1+L2+L3+L4+L5+L6+L7+L8+L9
Height difference between indoor unit above indoor and outdoor units	90**	H
Outdoor unit under	110**	H
Height difference between indoor units	30**	H

## ADVANCED TECHNOLOGY

- \*1. Standard lengths 90m, if >90m, enlarge the pipe diameter as pipe "C" diameter rules.
- \*2. Standard lengths 40m, if >40m, the pipe between the first branch and the farthest indoor unit need to enlarge one size (refer to pipe "A" & "B" diameter rules).
- \*3. Standard lengths 15m, if >15m, the pipe between indoor units and the nearest branch pipe need to enlarge one size (refer to pipe "A" diameter rules).
- \*4. Standard height differences 50m, if 50m < x < 70m, need meet following conditions.
  - 1) Indoor rated capacity/outdoor corrected capacity ≤ 130%.
  - 2) Set long pipe mode from outdoor PCB.
  - 3) Gas pipe and liquid pipe of main pipe need to enlarge one size, refer to pipe "C" diameter rules.
  - 4) If single way total pipe length > 500m, need to add compressor oil 0.3L/100m (pipe length less than 100m, count as 100m).

For example, if the total pipe length is 620m, then we should add 0.6L compressor oil.  
If >70m, please contact the local qualified serviceman or supplier. (If >70m, there is same warning in selection software popping up).

### Design of control condenser with electronic expansion valve

The condenser is controlled by two electronic expansion valves respectively, which can reasonably use the heat exchanger area according to the demand of IDU heat exchange temperature, distribute the refrigerant flow according to the load demand, to ensure high-performance heat exchange efficiency.

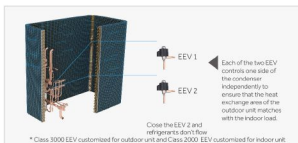

## HIGH EFFICIENCY

### Supper efficiency with full DC inverter compressor

Matches up inverter with step less compressor, the durability and stability of the compressor are guaranteed, fault can be reduced.

**Exhaust temperature sensor**

Soft scroll plate design, compared with the common scroll plate, it reduce the leakage loss and mechanical loss, more efficiency.

The soft structure and overpressure protection of circulating valve, both of them can effectively reduce stress loss. The compressor is more stable and also efficiency.

We adopted high pressure chamber compressor and low oil side structure design, to ensure the reliable oil supply of the compressor, and lubricate all parts effectively.

Adopt new type of cup design, reduce the disturbance of high speed rotation oil level, also reduce the oil discharge, improve lubrication efficiency, reduce friction loss.

Each compressor is adopted oil temperature sensor and the discharge temperature sensor, detecting the discharge temperature and oil temperature of compressor, cooperated with the compressor frequency and the EEV control, to ensure exhaust heat and oil temperature superheat kept within the optimal range, ensure that the oil dilution is maintained at a safe level at all times.

Integrated design of support and shell, to ensure the compressor running stably.

Three stage oil return inside the compressor:

- Gravity oil return
- Centrifugal oil return
- Structure shelter oil return

**Oil temperature sensor**

## HIGH EFFICIENCY

### Speedless inverter DC-motor

Outdoor unit matches efficient variable-speed DC-motor, driven by sine wave, wider efficiency range and torque range, motor efficiency is increased by 17%, air fan of outdoor unit can achieve 0-91Hz stepless frequency.



### New one-piece of four-way heat exchanger

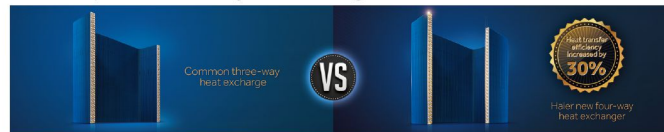

### Temperature approaching technology

The main problem of an ordinary inverter VRF system lies in that its compressor starts and stops frequently, stopping when the room temperature reaches the setting temperature and restarting when the same becomes higher than the setting temperature, though the inverter technology has improved such a problem greatly, the energy consumption caused by system restart is still a problem that cannot be ignored. AQUA MRV 5 series units adopts the temperature approaching technology, which enables the VRF system to maintain a low-frequency operating state all the time when the room temperature is close to the setting temperature but don't reach the setting temperature, thus avoiding the energy waste caused by frequent on/off.

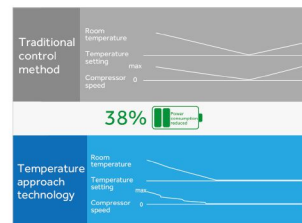

## SUPER COMFORT

### Wide operation temperature

The heating operation temperature can be as low as -23°C, and the heating is more powerful in winter, the cooling operation temperature can reach 50°C, better in summer.



### Precise temperature control at ±0.5°C

With twin pressure sensors and twin EEVs, the refrigerant volume can be adjusted automatically to realize precise temperature control, improving indoor comfort.



## ❄️ SUPER COMFORT

### Intelligent triple backup operation technology

- For the double-compressor system, when one compressor breakdown, the other compressor can be put into backup operation immediately to ensure the user needs.
- For the multi-module combination, in case of breakdown of one outdoor unit, this unit can be interrupted from the system so that the other modules can continue to operate.
- Super-long backup operation time, which can reach up to 8 hours.

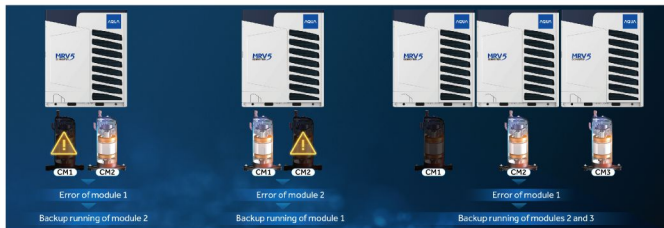

### Multiple modes available to meet the needs of different users



**Operation mode:**  
Cooling priority, heating priority, cooling only, heating only, and VIP priority



**Silent mode:**  
Seven-position silent mode available (nighttime silent mode and six-position silent mode)



**Static pressure mode:**  
No static pressure mode, low static pressure mode, medium static pressure mode, and high static pressure mode

### Rotary electric control box design

Rotary electric control box design, while maintaining the internal space, maintainer only need to rotate the box, do not need to dismantle the box, easy and fast maintenance.



## ❄️ EASY INSTALLATION

### 4-way pipe connection

You can freely choose the front, back, left side, right side of the unit to connect the pipe, easy to install and design.



## ❄️ EASY INSTALLATION

### Auto addressing indoor units

The ODU can automatically address to the indoor unit through the module on PCB, and the controller can search and set the address of the indoor unit, more convenient.



### Automatic oil balancing

Without oil balancing pipe, the oil is balanced automatically. This simplifies system design and improves reliability.



### Automatic snow clearing and dust removal function

According to the ash accumulation on the outdoor heat exchanger, the unit will blow away the dust, according to the reverse operation of the fan.



### Piping refrigerant storage technology

Advanced refrigerant control technology, the refrigerant is stored in the indoor and outdoor machine piping, remove the high pressure tank, less refrigerant filling in unit, high efficiency.



### 110Pa external static pressure design

The static pressure of the air outlet is up to 110Pa, which can meet the cooling effect of the layered arrangement of the outdoor unit.



Installation of duct

The outdoor unit is hidden inside the building without affecting the overall image of the building

# DC INVERTER MRV5



Total pipe length 1000m,  
height drop 110m



Space saving



Auto addressing  
indoor units



Better cooling capacity

# 3/380~415/50/60



Model		AV08MVEVS	AV10MVEVS	AV12MVEVS	AV14MVEVS	AV18MVEVS	
Capacity	Combination model		/	/	/	/	
			/	/	/	/	
			/	/	/	/	
Capacity	Capacity range	HP	8	10	12	14	
	Cooling	kW	25.2	28.0	33.5	40.0	
	Heating	kW	27.0	31.5	37.5	45.0	
Electrical parameters	Power supply		PhV/Hz	3/380~415/50/60	3/380~415/50/60	3/380~415/50/60	
	Cooling	Rated power input	kW	5.60	6.80	8.40	10.90
		Max power input	kW	12.000	12.900	13.800	16.400
		Rated current	A	9.45	11.48	14.18	18.40
		Max current	A	20.26	21.78	23.30	27.69
		Rated power input	kW	5.20	6.30	8.00	10.30
		Max power input	kW	10.50	12.20	12.50	15.10
	Heating	Rated current	A	8.78	10.64	13.51	17.39
		Max current	A	18.40	20.60	21.30	25.49
		EER	W/W	4.50	4.12	3.99	3.67
	COP	W/W	5.19	5.00	4.69	4.37	
	Performance	Air flow (H)	m³/h	11000	11000	12000	13500
Sound pressure level (H)		dB(A)	56	56	59	60	
Sound power level (H)		dB(A)	67	67	70	71	
External dimensions(W/D/H)		mm	980/750/1690				
Shipping dimensions(W/D/H)		mm	1070/850/1858				
Net/Shipping weight		kg	224/250		244/270		
Installation	Compressor type		DC INV. SCROLL	DC INV. SCROLL	DC INV. SCROLL	DC INV. SCROLL	
	Compressor brand		MITSUBISHI ELECTRIC	MITSUBISHI ELECTRIC	MITSUBISHI ELECTRIC	MITSUBISHI ELECTRIC	
	Compressor quantity		1INV	1INV	1INV	1INV	
	Refrigerant type		R410A	R410A	R410A	R410A	
	Refrigerant charge		kg	8.5	8.5	10	
	Refrigerant liquid pipe		mm	9.52	9.52	12.7	
	Refrigerant gas pipe		mm	19.05	22.22	25.4	
	Max. total pipe length		m	1000	1000	1000	
	Max. pipe length (Equivalent/Actual)		m	260/220	260/220	260/220	
	Max drop between L.U. & O.U. (CU. diameter) *1		m	110/90	110/90	110/90	
	Standard drop between L.U. & O.U. (CU. diameter) *2		m	50/40	50/40	50/40	
	Max drop between L.U. *3		m	30	30	30	
	Standard drop between L.U. *4		m	18	18	18	
	External static pressure		Pa	110	110	110	
	Connection ratio	Connectable indoor unit ratio	%	50-130	50-130	50-130	
Maximum number of indoor units			13	16	20		
Working temp.	Cooling	°C	-5~50		-5~50		
	Heating	°C	-23~21		-23~21		



AV08MVEVS  
AV10MVEVS  
AV12MVEVS  
AV14MVEVS  
AV16MVEVS

AV18MVEVS  
AV20MVEVS  
AV22MVEVS  
AV24MVEVS  
AV26MVEVS

Max. drop between L.U. & O.U. \*1  
Standard drop between L.U. & O.U. \*2  
Max. drop between L.U. \*3  
Standard drop between L.U. \*4

\* If the height difference between the outdoor and the indoor units is from 50 to 130m, you MUST contact your local distributor/dealer for individual design and production.  
\* If the height difference between the indoor units is from 18 to 30m, you MUST contact your local distributor/dealer for individual design and production.  
\* Standard design and production in the factory.  
\* All the specifications are tested under normal outdoor cooling indoor temp. is 27°C DB/19°C WB/Outdoor temp. 35°C DB/24.6°C WB/heating indoor temp. 20°C DB/heating outdoor temp. 7°C DB/9°C WB

# DC INVERTER MRV5

# 3/380~415/50/60



Total pipe length 1000m,  
height drop 110m



Space saving



Auto addressing indoor units



Better cooling capacity



AV08MVEVS  
AV10MVEVS  
AV12MVEVS  
AV14MVEVS  
AV16MVEVS



AV18MVEVS  
AV20MVEVS  
AV24MVEVS  
AV26MVEVS



Model		AV18MVEVS	AV20MVEVS	AV22MVEVS	AV24MVEVS	AV26MVEVS	AV28MVEVS	AV30MVEVS	AV32MVEVS		
Capacity	Combination model		/	/	/	/	/	AV14MVEVS	AV16MVEVS	AV18MVEVS	
			/	/	/	/	/	AV14MVEVS	AV16MVEVS	AV18MVEVS	
			/	/	/	/	/				
			/	/	/	/	/				
Electrical parameters	Capacity range	HP	18	20	22	24	26	28	30	32	
	Cooling	KW	50.4	56.0	61.5	68.0	73.5	80.0	85.0	90.0	
	Heating	KW	56.5	61.5	69.0	75.0	82.5	90.0	95.0	100.0	
	Power supply	PhV/Hz	3/380-415/50/60	3/380-415/50/60	3/380-415/50/60	3/380-415/50/60	3/380-415/50/60	3/380-415/50/60	3/380-415/50/60	3/380-415/50/60	
	Cooling	Rated power input	KW	14.30	15.10	16.50	17.60	18.80	21.80	22.70	23.60
		Max power input	KW	21.400	25.300	28.500	29.100	33.000	32.800	35.600	38.400
		Rated current	A	24.14	25.49	27.86	29.71	31.74	36.80	38.32	39.84
		Max current	A	36.15	42.37	48.11	49.13	55.80	55.37	60.10	64.83
	Heating	Rated power input	KW	15.40	14.60	15.40	16.80	17.70	20.60	21.50	22.40
		Max power input	KW	17.70	22.70	25.50	26.50	30.40	30.20	33.50	36.80
Rated current		A	22.62	24.65	26.00	28.26	29.88	34.78	36.30	37.82	
Max current		A	29.88	38.32	43.05	44.74	51.32	50.98	56.55	62.13	
EER	W/W	3.52	3.71	3.73	3.86	3.91	3.67	3.74	3.81		
COP	W/W	4.22	4.21	4.48	4.35	4.66	4.37	4.42	4.46		
Air flow (H)	m <sup>3</sup> /h	17000	17000	18000	18000	19000	27000	27000	27000		
Sound pressure level (H)	dB(A)	61	61	61	62	62	62	62	62	63	
Sound power level (H)	dB(A)	72	72	72	73	73	73	73	73	74	
External dimensions(W/D/H)	mm	1410/750/1690			1410/750/1690			980/750/1690-980/750/1690			
Shipping dimensions(W/D/H)	mm	1515/850/1858			1515/850/1858			1070/850/1858-1070/850/1858			
Net/Shipping weight	kg	287/317			370/400			244/270+244/270		244/270+244/270	
Compressor type	DC INV. SCROLL	DC INV. SCROLL	DC INV. SCROLL	DC INV. SCROLL	DC INV. SCROLL	DC INV. SCROLL	DC INV. SCROLL	DC INV. SCROLL	DC INV. SCROLL		
Compressor brand	MITSUBISHI ELECTRIC	MITSUBISHI ELECTRIC	MITSUBISHI ELECTRIC	MITSUBISHI ELECTRIC	MITSUBISHI ELECTRIC	MITSUBISHI ELECTRIC	MITSUBISHI ELECTRIC	MITSUBISHI ELECTRIC	MITSUBISHI ELECTRIC		
Compressor quantity	1NV	2NV	2NV	2NV	2NV	2NV	2NV	2NV	2NV		
Refrigerant type	R410A	R410A	R410A	R410A	R410A	R410A	R410A	R410A	R410A		
Refrigerant charge	kg	10	10	10	10	10	20	20	20		
Refrigerant liquid pipe	mm	15.88	15.88	15.88	15.88	15.88	15.88	19.05	19.05		
Refrigerant gas pipe	mm	28.58	28.58	28.58	28.58	28.58	28.58	31.8	31.8		
Max. total pipe length	m	1000	1000	1000	1000	1000	1000	1000	1000		
Max. pipe length (Equivalent/Actual)	m	260/220	260/220	260/220	260/220	260/220	260/220	260/220	260/220		
Max drop between L.U & O.U. (C.U.) standard *1	m	110/90	110/90	110/90	110/90	110/90	110/90	110/90	110/90		
Standard drop between L.U & O.U. (C.U.) standard *2	m	50/40	50/40	50/40	50/40	50/40	50/40	50/40	50/40		
Max drop between L.U *3	m	30	30	30	30	30	30	30	30		
Standard drop between L.U *4	m	18	18	18	18	18	18	18	18		
External static pressure	Pa	110	110	110	110	110	110	110	110		
Connectable indoor unit ratio	%	50-130	50-130	50-130	50-130	50-130	50-130	50-130	50-130		
Maximum number of indoor units		30	33	36	40	43	47	50	53		
Working temp.	Cooling	°C	-5~50				-5~50				
	Heating	°C	-23~21				-23~21				

\*1 Max drop between L.U & O.U. \*1  
 \*2 Standard drop between L.U & O.U. \*2  
 \*3 Max drop between L.U \*3  
 \*4 Standard drop between L.U \*4  
 \*5 Airflow specifications are based under nominal conditions in cooling: indoor temp. is 27°C DB/19°C WB, outdoor temp. is 35°C DB/24°C WB, outdoor temp. is 20°C DB/18°C WB, outdoor temp. is 20°C DB/18°C WB in heating; outdoor temp. is 7°C DB/18°C WB

# MRV5 DC INVERTER



Total pipe length 1000m,  
height drop 110m



Space saving



Auto addressing  
indoor units



Better cooling capacity

# 3/380~415/50/60



Model		AV34MVEVS		AV36MVEVS		AV38MVEVS		AV40MVEVS		AV42MVEVS		AV44MVEVS		AV46MVEVS		
		AV16MVEVS		AV18MVEVS		AV18MVEVS		AV20MVEVS		AV20MVEVS		AV22MVEVS		AV22MVEVS		
Combination model		AV18MVEVS		AV18MVEVS		AV20MVEVS		AV20MVEVS		AV22MVEVS		AV22MVEVS		AV22MVEVS		
		/		/		/		/		/		/		/		
		/		/		/		/		/		/		/		
Capacity	Capacity range	HP	34	36	38	40	42	44	46							
	Cooling	kW	95.4	100.8	106.4	112.0	117.5	123.0	129.5							
	Heating	kW	106.5	113.0	118.0	123.0	130.5	138.0	142.0							
Electrical parameters	Power supply	PhV/Hz	3/380~415/50/60		3/380~415/50/60		3/380~415/50/60		3/380~415/50/60		3/380~415/50/60		3/380~415/50/60		3/380~415/50/60	
	Cooling	Rated power input	kW	26.10	28.60	29.40	30.20	31.60	33.00	34.10						
		Max power input	kW	40.600	42.800	46.500	50.200	53.600	57.000	57.600						
		Rated current	A	44.06	48.28	49.63	50.98	53.35	55.71	57.57						
	Heating	Max current	A	68.54	72.26	78.50	84.75	90.49	96.23	97.24						
		Rated power input	kW	24.60	26.80	28.00	29.20	30.00	30.80	32.20						
		Max power input	kW	36.10	35.40	40.40	45.40	48.20	51.00	52.00						
	Performance	Rated current	A	41.53	45.24	47.27	49.30	50.65	52.00	54.36						
		Max current	A	60.94	59.76	68.20	76.64	81.37	86.10	87.79						
		EER	W/W	3.66	3.52	3.62	3.71	3.72	3.73	3.80						
	COP	W/W	4.33	4.22	4.21	4.21	4.35	4.48	4.41							
	Air flow (H)	m <sup>3</sup> /h	30500	34000	34000	34000	35000	36000	36000	36000						
Sound pressure level (H)	dB(A)	63.5	64	64	64	64	64	64	64.5							
Sound power level (H)	dB(A)	74.5	75	75	75	75	75	75	75							
External dimensions(W/D/H)	mm	980/750/1690~1410/750/1690						1410/750/1690~1410/750/1690								
Shipping dimensions(W/D/H)	mm	1070/850/1858~1515/850/1858						1515/850/1858~1515/850/1858								
Net/Shipping weight	kg	244/270+287/317		287/317+287/317		287/317+370/400		370/400+370/400		370/400+370/400		370/400+370/400		370/400+370/400		
Compressor type		DC INV. SCROLL		DC INV. SCROLL		DC INV. SCROLL		DC INV. SCROLL		DC INV. SCROLL		DC INV. SCROLL		DC INV. SCROLL		
Compressor brand		MITSUBISHI ELECTRIC		MITSUBISHI ELECTRIC		MITSUBISHI ELECTRIC		MITSUBISHI ELECTRIC		MITSUBISHI ELECTRIC		MITSUBISHI ELECTRIC		MITSUBISHI ELECTRIC		
Compressor quantity		2INV		2INV		3INV		4INV		4INV		4INV		4INV		
Refrigerant type		R410A		R410A		R410A		R410A		R410A		R410A		R410A		
Refrigerant charge	kg	20		20		20		20		20		20		20		
Refrigerant liquid pipe	mm	19.05		19.05		19.05		19.05		19.05		19.05		19.05		
Refrigerant gas pipe	mm	31.8		38.1		38.1		38.1		38.1		38.1		38.1		
Max. total pipe length	m	1000		1000		1000		1000		1000		1000		1000		
Max. pipe length (Equivalent/Actual)	m	260/220		260/220		260/220		260/220		260/220		260/220		260/220		
Max drop between U1 & O.U. (O.U. down/up) *1	m	110/90		110/90		110/90		110/90		110/90		110/90		110/90		
Standard drop between U1 & O.U. (O.U. up/down) *2	m	50/40		50/40		50/40		50/40		50/40		50/40		50/40		
Max drop between U1 *3	m	30		30		30		30		30		30		30		
Standard drop between U1 *4	m	18		18		18		18		18		18		18		
External static pressure	Pa	110		110		110		110		110		110		110		
Connection ratio		%		50-130		50-130		50-130		50-130		50-130		50-130		
Working temp.		°C		-5-50		-5-50		-5-50		-5-50		-5-50		-5-50		
		°C		-23-21		-23-21		-23-21		-23-21		-23-21		-23-21		



AV18MVEVS  
AV10MVEVS  
AV12MVEVS  
AV14MVEVS  
AV16MVEVS



AV18MVEVS  
AV20MVEVS  
AV22MVEVS  
AV24MVEVS  
AV26MVEVS

\*1 Max drop between U1(O.U.) \*1  
Standard design and production in the factory.  
\*2 Max drop between U1 \*3  
Standard design and production in the factory.  
\*3 All the specifications are tested under normal condition (cooling indoor temp. is 27°C DB/19°C WB; outdoor temp. 35°C DB/24.9°C WB; heating indoor temp. 20°C DB/17.5°C WB; heating outdoor temp. 7°C DB/6.5°C WB)

# DC INVERTER MRV5

# 3/380~415/50/60



Total pipe length 1000m,  
height drop 110m



Space saving



Auto addressing  
indoor units



Better cooling capacity



AV08MVEVS  
AV10MVEVS  
AV12MVEVS  
AV14MVEVS  
AV16MVEVS



AV18MVEVS  
AV20MVEVS  
AV22MVEVS  
AV24MVEVS  
AV26MVEVS



Model		AV18MVEVS	AV20MVEVS	AV22MVEVS	AV24MVEVS	AV26MVEVS	AV28MVEVS	AV30MVEVS	AV32MVEVS	AV34MVEVS	AV36MVEVS	AV38MVEVS	AV40MVEVS	AV42MVEVS	
Capacity	Combination model		AV24MVEVS	AV24MVEVS	AV26MVEVS	AV26MVEVS	AV28MVEVS	AV28MVEVS	AV30MVEVS	AV30MVEVS	AV32MVEVS	AV32MVEVS	AV34MVEVS	AV34MVEVS	
			/	/	/	/	/	/	/	/	/	/	/	/	
	Capacity range		HP	48	50	52	54	56	58	60	62	64	66	68	70
	Cooling		kW	136.0	141.5	147.0	152.5	158.0	163.5	169.0	174.5	180.0	185.5	191.0	196.5
Heating		kW	146.0	155.5	165.0	174.5	184.0	193.5	203.0	212.5	222.0	231.5	241.0	250.5	
Electrical parameters	Power supply		PhV/Hz	3/380~415/50/60	3/380~415/50/60	3/380~415/50/60	3/380~415/50/60	3/380~415/50/60	3/380~415/50/60	3/380~415/50/60	3/380~415/50/60	3/380~415/50/60	3/380~415/50/60	3/380~415/50/60	
	Cooling	Rated power input	kW	35.20	36.40	37.60	42.90	43.70	44.50	45.30	46.10	46.90	47.70	48.50	49.30
		Max power input	kW	58.20	62.10	66.00	64.20	67.90	71.60	75.30	79.00	82.70	86.40	90.10	93.80
		Rated current	A	59.42	61.45	63.48	72.42	73.77	75.13	76.48	77.84	79.19	80.54	81.89	83.24
		Max current	A	98.25	104.93	111.60	108.38	114.63	120.88	127.12	133.36	139.61	145.85	152.10	158.34
	Heating	Rated power input	kW	33.60	34.50	35.40	40.20	41.40	42.60	43.80	45.00	46.20	47.40	48.60	49.80
		Max power input	kW	53.00	56.90	60.80	53.10	58.10	63.10	68.10	73.10	78.10	83.10	88.10	93.10
		Rated current	A	56.72	58.24	59.76	67.87	69.89	71.92	73.94	75.97	77.99	79.99	81.99	83.99
		Max current	A	89.48	96.06	102.64	102.64	89.64	98.08	106.53	114.97	123.41	131.85	140.29	148.73
	EER	W/W	3.86	3.89	3.91	3.52	3.59	3.65	3.71	3.72	3.73	3.74	3.75	3.76	
	COP	W/W	4.35	4.51	4.66	4.22	4.21	4.21	4.21	4.21	4.21	4.21	4.21	4.21	
	Air flow (H)	m <sup>3</sup> /h	36000	37000	38000	51000	51000	51000	51000	51000	51000	51000	51000	51000	
Sound pressure level (H)	dB(A)	65	65	65	65.8	65.8	65.8	65.8	65.8	65.8	65.8	65.8	65.8		
Sound power level (H)	dB(A)	76	76	76	76.5	76.5	76.5	76.5	76.5	76.5	76.5	76.5	76.5		
Performance	External dimensions(W/D/H)		1410/750/1690-1410/750/1690			1410/750/1690-1410/750/1690			1410/750/1690-1410/750/1690			1410/750/1690-1410/750/1690			
	Shipping dimensions(W/D/H)		1515/850/1858-1515/850/1858			1515/850/1858-1515/850/1858			1515/850/1858-1515/850/1858			1515/850/1858-1515/850/1858			
	Net/Shipping weight		kg 370/400-370/400			kg 370/400-370/400			kg 287/317-287/317+370/400			kg 287/317-370/400+370/400			
Installation	Compressor type		DC INV. SCROLL		DC INV. SCROLL		DC INV. SCROLL		DC INV. SCROLL		DC INV. SCROLL		DC INV. SCROLL		
	Compressor brand		MITSUBISHI ELECTRIC		MITSUBISHI ELECTRIC		MITSUBISHI ELECTRIC		MITSUBISHI ELECTRIC		MITSUBISHI ELECTRIC		MITSUBISHI ELECTRIC		
	Compressor quantity		4INV		4INV		4INV		3INV		4INV		6INV		
	Refrigerant type		R410A		R410A		R410A		R410A		R410A		R410A		
	Refrigerant charge		kg 20		20		20		30		30		30		
	Refrigerant liquid pipe		mm 19.05		19.05		19.05		19.05		19.05		19.05		
	Refrigerant gas pipe		mm 38.1		38.1		38.1		38.1		41.3		41.3		
	Max. total pipe length		m 1000		1000		1000		1000		1000		1000		
	Max. pipe length (Equivalent/Actual)		m 260/220		260/220		260/220		260/220		260/220		260/220		
	Max. drop between L.U. & O.U. (C.U. dependent)*1		m 110/90		110/90		110/90		110/90		110/90		110/90		
	Standard drop between L.U. & O.U. (C.U. dependent)*2		m 50/40		50/40		50/40		50/40		50/40		50/40		
	Max. drop between L.U.*3		m 30		30		30		30		30		30		
	Standard drop between L.U.*4		m 18		18		18		18		18		18		
	External static pressure		Pa 110		110		110		110		110		110		
	Connectable indoor unit ratio		%		50-130		50-130		50-130		50-130		50-130		
Working temp.	Maximum number of indoor units		64		64		64		64		64		64		
	Cooling		°C		-5-50		-5-50		-5-50		-5-50		-5-50		
	Heating		°C		-23-21		-23-21		-23-21		-23-21		-23-21		

\*1 Max. drop between L.U. & O.U. (C.U. dependent)  
\*2 Standard drop between L.U. & O.U. (C.U. dependent)  
\*3 Max. drop between L.U.  
\*4 Standard drop between L.U.

\*5 If the height difference between the outdoor and the indoor units from 30 to 120m, you MUST contact your local distributor/ dealer for individual design and production.  
\*6 Standard design and production in the factory.  
\*7 If the height difference between the indoor units is from 18 to 20m, you MUST contact your local distributor/ dealer for individual design and production.  
\*8 Standard design and production in the factory.  
\*9 All the specifications are based under normal condition (cooling: indoor temp is 27°C/81°F; outdoor temp 35°C/95°F; heating: indoor temp is 20°C/68°F; outdoor temp is 7°C/45°F)

# MRV5 DC INVERTER

# 3/380~415/50/60



Total pipe length: 1000m,  
height drop 110m



Space saving



Auto addressing  
indoor units



Better cooling capacity



AV08MVEVS  
AV10MVEVS  
AV12MVEVS  
AV14MVEVS  
AV16MVEVS



AV18MVEVS  
AV20MVEVS  
AV22MVEVS  
AV24MVEVS  
AV26MVEVS



Model		AV64MVEVS	AV66MVEVS	AV68MVEVS	AV70MVEVS	AV72MVEVS	AV74MVEVS	AV76MVEVS	AV78MVEVS		
Capacity	Combination model										
		AV22MVEVS	AV22MVEVS	AV22MVEVS	AV22MVEVS	AV24MVEVS	AV26MVEVS	AV26MVEVS	AV26MVEVS		
		AV22MVEVS	AV22MVEVS	AV24MVEVS	AV24MVEVS	AV24MVEVS	AV24MVEVS	AV26MVEVS	AV26MVEVS		
		AV20MVEVS	AV22MVEVS	AV24MVEVS	AV24MVEVS	AV24MVEVS	AV24MVEVS	AV24MVEVS	AV26MVEVS		
Electrical parameters	Capacity range	HP	64	66	68	70	72	74	76	78	
	Cooling	kW	179.0	184.5	191.0	197.5	204.0	209.5	215.0	220.5	
	Heating	kW	199.5	207.0	211.0	215.0	219.0	228.5	238.0	247.5	
	Power supply	PhV/Hz	3/380~415/50/60	3/380~415/50/60	3/380~415/50/60	3/380~415/50/60	3/380~415/50/60	3/380~415/50/60	3/380~415/50/60	3/380~415/50/60	
	Cooling	Rated power input	kW	48.10	49.50	50.60	51.70	52.80	54.00	55.20	56.40
		Max power input	kW	82.10	85.50	86.10	86.70	87.30	91.20	95.10	99.00
		Rated current	A	81.20	83.57	85.42	87.28	89.14	91.16	93.19	95.21
	Heating	Max current	A	138.60	144.34	145.35	146.37	147.38	154.05	160.73	167.40
		Rated power input	kW	45.40	46.20	47.60	49.00	50.40	51.30	52.20	53.10
		Max power input	kW	73.70	76.50	77.50	78.50	79.50	83.40	87.30	91.20
Performance	Rated current	A	76.64	78.00	80.36	82.72	85.09	86.61	88.12	89.64	
	Max current	A	124.42	129.15	130.84	132.52	134.21	140.80	147.38	153.96	
	EER	W/W	3.72	3.73	3.77	3.82	3.86	3.88	3.89	3.91	
	COP	W/W	4.39	4.48	4.43	4.39	4.35	4.45	4.56	4.66	
	Air flow (H)	m <sup>3</sup> /h	53000	54000	54000	54000	54000	55000	56000	57000	
	Sound pressure level (H)	dB(A)	65.8	65.8	66	66.5	66.8	66.8	66.8	66.8	
	Sound power level (H)	dB(A)	76.5	76.5	77	77.5	77.8	77.8	77.8	77.7	
	External dimensions(W/D/H)	mm	1410/750/1690+1410/750/1690+1410/750/1690				1410/750/1690+1410/750/1690+1410/750/1690				
	Shipping dimensions(W/D/H)	mm	1515/850/1858+1515/850/1858+1515/850/1858				1515/850/1858+1515/850/1858+1515/850/1858				
	Net/Shipping weight	kg	370/400+370/400+370/400				370/400+370/400+370/400				
Installation	Compressor type	DC INV. SCROLL	DC INV. SCROLL	DC INV. SCROLL	DC INV. SCROLL	DC INV. SCROLL	DC INV. SCROLL	DC INV. SCROLL	DC INV. SCROLL		
	Compressor brand	MTS,BSFH ELECTRIC	MTS,BSFH ELECTRIC	MTS,BSFH ELECTRIC	MTS,BSFH ELECTRIC	MTS,BSFH ELECTRIC	MTS,BSFH ELECTRIC	MTS,BSFH ELECTRIC	MTS,BSFH ELECTRIC		
	Compressor quantity	6INV	6INV	6INV	6INV	6INV	6INV	6INV	6INV		
	Refrigerant type	R410A	R410A	R410A	R410A	R410A	R410A	R410A	R410A		
	Refrigerant charge	kg	30	30	30	30	30	30	30		
	Refrigerant liquid pipe	mm	19.05	19.05	22.2	22.2	22.2	22.2	22.2		
	Refrigerant gas pipe	mm	41.3	41.3	44.5	44.5	44.5	44.5	44.5		
	Max total pipe length	m	1000	1000	1000	1000	1000	1000	1000		
	Max pipe length (Equivalent/Actual)	m	260/220	260/220	260/220	260/220	260/220	260/220	260/220		
	Max drop between U & O.U. (C.U. standard) *1	m	110/90	110/90	110/90	110/90	110/90	110/90	110/90		
	Standard drop between U & O.U. (C.U. standard) *2	m	50/40	50/40	50/40	50/40	50/40	50/40	50/40		
	Max drop between U. *3	m	30	30	30	30	30	30	30		
	Standard drop between U.L. *4	m	18	18	18	18	18	18	18		
	External static pressure	Pa	110	110	110	110	110	110	110		
	Connection ratio	Connectable indoor unit ratio	%	50-130	50-130	50-130	50-130	50-130	50-130	50-130	
Maximum number of indoor units			64	64	64	64	64	64	64		
Working temp.	Cooling	°C	-5~50		-5~50		-5~50		-5~50		
	Heating	°C	-23~21		-23~21		-23~21		-23~21		

\*1 Max drop between U&O.U. \*1  
Standard design and production in the factory.  
\*2 Max drop between U. \*3  
Standard design and production in the factory.  
\*4 All the specifications are based on standard indoor cooling, indoor temp.: 27°C DB/20°C WB; outdoor temp.: 35°C DB/18°C WB; indoor heating, outdoor temp.: 7°C DB/5°C WB

\*5 The height difference between the outdoor and the indoor units varies from 0m to 150m, you MUST contact your local distributor/dealer for individual design and production.  
Standard design and production in the factory.  
\*6 The height difference between the indoor units is from 18m to 30m, you MUST contact your local distributor/dealer for individual design and production.  
Standard design and production in the factory.

# DC INVERTER MRV5

# 3/380~415/50/60



Total pipe length 1000m, height drop 110m



Space saving



Auto addressing indoor units



Better cooling capacity



AV08MVEVS  
AV10MVEVS  
AV12MVEVS  
AV14MVEVS  
AV16MVEVS



AV18MVEVS  
AV20MVEVS  
AV22MVEVS  
AV24MVEVS  
AV26MVEVS

Model		AV80MVEVS	AV82MVEVS	AV84MVEVS	AV86MVEVS	AV88MVEVS	AV90MVEVS	AV92MVEVS		
Combination model	AV20MVEVS	AV20MVEVS	AV20MVEVS	AV20MVEVS	AV20MVEVS	AV22MVEVS	AV24MVEVS	AV24MVEVS		
	AV20MVEVS	AV20MVEVS	AV20MVEVS	AV20MVEVS	AV20MVEVS	AV22MVEVS	AV22MVEVS	AV22MVEVS		
	AV20MVEVS	AV20MVEVS	AV22MVEVS	AV22MVEVS	AV22MVEVS	AV22MVEVS	AV22MVEVS	AV22MVEVS		
	AV20MVEVS	AV22MVEVS	AV22MVEVS	AV22MVEVS	AV22MVEVS	AV22MVEVS	AV22MVEVS	AV22MVEVS		
	AV20MVEVS	AV22MVEVS	AV22MVEVS	AV22MVEVS	AV22MVEVS	AV22MVEVS	AV22MVEVS	AV22MVEVS		
Capacity	Capacity range	HP	80	82	84	86	88	90		
	Cooling	kW	2240	229.5	235.0	240.5	246.0	252.5		
	Heating	kW	246.0	253.5	261.0	268.5	276.0	280.0		
	Power supply	PhV/Hz	3/380-415/50/60	3/380-415/50/60	3/380-415/50/60	3/380-415/50/60	3/380-415/50/60	3/380-415/50/60	3/380-415/50/60	
Electrical parameters	Cooling	Rated power input	kW	60.40	61.80	63.20	64.60	66.00	67.10	
		Max power input	kW	100.40	103.80	107.20	110.60	114.00	114.60	115.20
		Rated current	A	101.97	104.33	106.69	109.06	111.42	113.28	115.14
		Max current	A	169.50	175.24	180.98	186.72	192.46	193.47	194.48
	Heating	Rated power input	kW	58.40	59.20	60.00	60.80	61.60	63.00	64.40
		Max power input	kW	90.80	93.60	96.40	99.20	102.00	103.00	104.00
		Rated current	A	98.59	99.94	101.29	102.64	103.99	106.36	108.72
		Max current	A	153.29	158.02	162.74	167.47	172.20	173.89	175.57
	EER	W/W	3.71	3.71	3.72	3.72	3.73	3.76	3.80	
	COP		4.21	4.28	4.35	4.42	4.48	4.44	4.41	
Air flow (h)		68000	69000	70000	71000	72000	72000	72000		
Performance	Sound pressure level (h)	W/W	67	67	67	67	67	67.5		
	Sound power level (h)	m <sup>3</sup> /h	78	78	78	78	78	78.5		
Installation	External dimensions(W/D/H)	d(BA)	1410/750/1690 1690-1410/750/1690	1410/750/1690 1690-1410/750/1690	1410/750/1690 1690-1410/750/1690	1410/750/1690 1690-1410/750/1690	1410/750/1690 1690-1410/750/1690	1410/750/1690 1690-1410/750/1690		
	Shipping dimensions(W/D/H)	d(BA)	1515/850/1858 1858-1515/850/1858	1515/850/1858 1858-1515/850/1858	1515/850/1858 1858-1515/850/1858	1515/850/1858 1858-1515/850/1858	1515/850/1858 1858-1515/850/1858	1515/850/1858 1858-1515/850/1858		
	Net/Shipping weight	mm	370/400-370/400-370/400	370/400-370/400-370/400	370/400-370/400-370/400	370/400-370/400-370/400	370/400-370/400-370/400	370/400-370/400-370/400		
	Compressor type	mm	DC INV. SCROLL	DC INV. SCROLL	DC INV. SCROLL	DC INV. SCROLL	DC INV. SCROLL	DC INV. SCROLL		
	Compressor brand	mm	MTS/SBESH ELECTRIC	MTS/SBESH ELECTRIC	MTS/SBESH ELECTRIC	MTS/SBESH ELECTRIC	MTS/SBESH ELECTRIC	MTS/SBESH ELECTRIC		
	Compressor quantity	mm	8INV	8INV	8INV	8INV	8INV	8INV		
	Refrigerant type	mm	R410A	R410A	R410A	R410A	R410A	R410A		
	Refrigerant charge	mm	40	40	40	40	40	40		
	Refrigerant liquid pipe	mm	22.2	22.2	22.2	25.4	25.4	25.4		
	Refrigerant gas pipe	mm	44.5	44.5	44.5	50.8	50.8	50.8		
Performance	Max total pipe length	m	1000	1000	1000	1000	1000	1000		
	Max pipe length (Equivalent/Actual)	m	260/220	260/220	260/220	260/220	260/220	260/220		
	Max drop between U.I.&O.U. (C.U. standard)*1	m	110/90	110/90	110/90	110/90	110/90	110/90		
	Standard drop between U.I.&O.U. (C.U. standard)*2	m	50/40	50/40	50/40	50/40	50/40	50/40		
	Max drop between U.I.*3	m	30	30	30	30	30	30		
	Standard drop between U.I.*4	m	18	18	18	18	18	18		
	External static pressure	Pa	110	110	110	110	110	110		
	Connectable indoor unit ratio	%	50-130	50-130	50-130	50-130	50-130	50-130		
	Maximum number of indoor units		64	64	64	64	64	64		
	Working temp.	Cooling	°C		-5-50			-5-50		
Heating		°C		-23-21			-23-21			

\*1 Max drop between U.I.&O.U. \*1  
Standard drop between U.I.&O.U. \*2  
Max drop between U.I. \*3  
Standard drop between U.I. \*4

\* If the height difference between the outdoor and the indoor units is from 30 to 120m, you MUST contact your local distributor/dealer for individual design and installation.  
\* If the height difference between the outdoor and the indoor units is from 18 to 30m, you MUST contact your local distributor/dealer for individual design and production.  
\* All the specifications are based under normal condition (indoor cooling, indoor temp. is 27°C DB/19°C WB; outdoor temp. 35°C DB/24°C WB)

# DC INVERTER MRV5



Total pipe length: 1000m,  
height drop: 110m



30%  
Space saving



Auto addressing  
indoor units



Better cooling capacity

# 3/380~415/50/60



AV08MVEVS  
AV10MVEVS  
AV12MVEVS  
AV14MVEVS  
AV16MVEVS



AV18MVEVS  
AV20MVEVS  
AV22MVEVS  
AV24MVEVS  
AV26MVEVS

Model	AV98MVEVS	AV96MVEVS	AV98MVEVS	AV100MVEVS	AV102MVEVS	AV104MVEVS		
Capacity	Combination model		AV26MVEVS	AV26MVEVS	AV26MVEVS	AV26MVEVS		
			AV24MVEVS	AV24MVEVS	AV26MVEVS	AV26MVEVS		
			AV24MVEVS	AV24MVEVS	AV26MVEVS	AV26MVEVS		
			AV24MVEVS	AV24MVEVS	AV26MVEVS	AV26MVEVS		
			AV24MVEVS	AV24MVEVS	AV24MVEVS	AV26MVEVS		
Capacity range	HP	94	96	98	100	102		
	Cooling kW	265.5	272.0	277.5	283.0	288.5		
Heating kW		288.0	292.0	301.5	311.0	320.5		
	Power supply	PhV/Hz	3/380~415/50/60	3/380~415/50/60	3/380~415/50/60	3/380~415/50/60	3/380~415/50/60	
Electrical parameters	Cooling	Rated power input kW	69.30	70.40	71.60	72.80	74.00	
		Max power input kW	115.80	116.40	120.30	124.20	128.10	
		Rated current A	116.99	118.85	120.88	122.90	124.95	
	Heating	Max current A	195.49	196.51	203.18	209.85	216.53	
		Rated power input kW	65.80	67.20	68.10	69.00	69.90	
		Max power input kW	105.00	106.00	109.90	113.80	117.70	
	EER	W/W	3.85	3.86	3.88	3.89	3.90	
		COP	W/W	4.38	4.35	4.43	4.51	4.56
		Air flow (H)	m <sup>3</sup> /h	72000	72000	75000	74000	75000
	Performance	Sound pressure level (H)	dBA(A)	68	68	68	68	68
Sound power level (H)		dBA(A)	78.8	79	79	79	79	
External dimensions(W/D/H)	mm	1410/750/1690	1410/750/1690	1410/750/1690	1410/750/1690	1410/750/1690		
	Shipping dimensions(W/D/H)	mm	1515/850/1858	1515/850/1858	1515/850/1858	1515/850/1858	1515/850/1858	
	Net/Shipping weight	kg	370/400	370/400	370/400	370/400	370/400	
Installation	Compressor type	DC INV. SCROLL	DC INV. SCROLL	DC INV. SCROLL	DC INV. SCROLL	DC INV. SCROLL		
	Compressor brand	WFS/SEBCH ELECTRIC	WFS/SEBCH ELECTRIC	WFS/SEBCH ELECTRIC	WFS/SEBCH ELECTRIC	WFS/SEBCH ELECTRIC		
	Compressor quantity	8N/V	8N/V	8N/V	8N/V	8N/V		
	Refrigerant type	R410A	R410A	R410A	R410A	R410A		
	Refrigerant charge	kg	40	40	40	40	40	
	Refrigerant liquid pipe	mm	25.4	25.4	25.4	25.4	25.4	
	Refrigerant gas pipe	mm	50.8	50.8	54.1	54.1	54.1	
	Max total pipe length	m	1000	1000	1000	1000	1000	
	Max pipe length (Equivalent/Actual)	m	260/220	260/220	260/220	260/220	260/220	
	Max drop between (L&O.U./C.U.) (standard)*1	m	110/90	110/90	110/90	110/90	110/90	
	Standard drop between (L&O.U./C.U.) (standard)*2	m	50/40	50/40	50/40	50/40	50/40	
	Max drop between (L.U.)*3	m	30	30	30	30	30	
	Standard drop between (L.U.)*4	m	18	18	18	18	18	
	External static pressure	Pa	110	110	110	110	110	
	Connection ratio	Connectable indoor unit ratio	%	50-130	50-130	50-130	50-130	
Maximum number of indoor units			64	64	64	64		
Working temp.	Cooling	°C	-5~50		-5~50			
	Heating	°C	-23~21		-23~21			

\*1 Max drop between (L&O.U.)\*1  
Standard drop between (L&O.U.)\*2  
Max drop between (L.U.)\*3  
Standard drop between (L.U.)\*4

\*2 If the height difference between the outdoor and the indoor units is from 50 to 110m, you MUST contact your local distributor/dealer for individual design and production.  
Standard design and production in the factory.  
\*3 If the height difference between the indoor units is from 18 to 30m, you MUST contact your local distributor/dealer for individual design and production.  
Standard design and production in the factory.  
\*4 All the specific values are based on normal nominal condition for cooling, indoor temp. is 27°C DB/19°C WB, outdoor temp. 35°C DB/24°C WB, indoor temp. is 20°C DB/ heating, outdoor temp. is 7°C DB/5°C WB

# Dimensions

AV08IMVEVS AV10IMVEVS AV12IMVEVS AV14IMVEVS AV16IMVEVS

Unit:mm

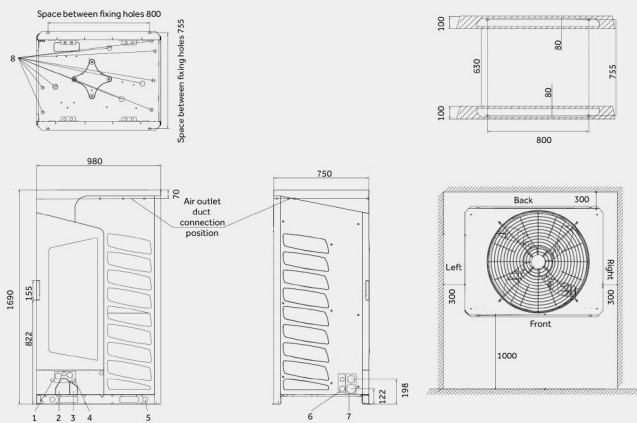

No.	Name	Remark
1	Signal line hole Ø25	Using the rubber plug in the unit's attachment for protection
2	Pipe outlet for 2-pipe system	
3	Pipe outlet for 3-pipe system	
4	Power supply hole	According to the wire diameter size to choose the appropriate line hole, and using the line sheath in the unit's attachment for protection
5	Hoisting hole	
6	Power supply of signal line hole	
7	Refrigerant pipe outlet	
8	Drain hole	

AV18IMVEVS AV20IMVEVS AV22IMVEVS AV24IMVEVS AV26IMVEVS

Unit:mm

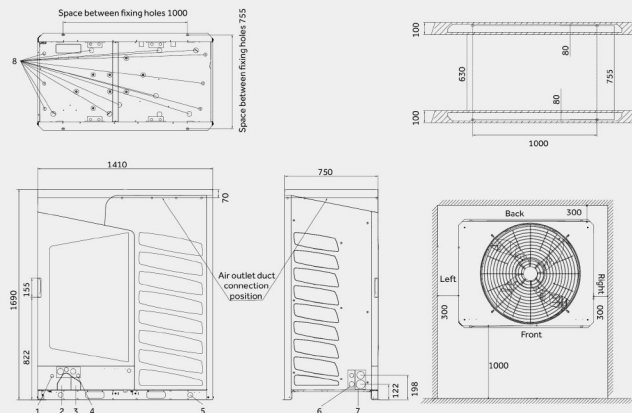

No.	Name	Remark
1	Signal line hole Ø25	Using the rubber plug in the unit's attachment for protection
2	Pipe outlet for 2-pipe system	
3	Pipe outlet for 3-pipe system	
4	Power supply hole	According to the wire diameter size to choose the appropriate line hole, and using the line sheath in the unit's attachment for protection
5	Hoisting hole	
6	Power supply of signal line hole	
7	Refrigerant pipe outlet	
8	Drain hole	

# MRV5-C

DC INVERTER

**055** Features & Benefits

**060** MRV 5-C Outdoor



# MRV 5-C

- Advanced Technology
- High Efficiency
- Super Comfort
- Easy Installation

## ADVANCED TECHNOLOGY

### Wide voltage operation

The new MRV 5-C adopt wide voltage filter board, this can insure the unit stable working in voltage range between 310V~460V.(note: Outdoor unit)



## ADVANCED TECHNOLOGY

### Total pipe length 1000m,height drop 110m

- Max. total pipe length 1000m
- Max. actual pipe length 220m
- Max. equivalent pipe length 260m
- Max. drop between IDU&ODU / 90m (outdoor unit up) / 110m (outdoor unit down)
- Max. drop between IDU&IDU 30m\*

\*If the total pipe length is between 300m and 1100m or the drop between IDU and ODU more than 50m, please contact your local dealer.



2. Allowable pipe length and height difference between indoor and outdoor outdoor unit (outdoor unit above)

Pipe length and height difference (m)	Allowable value	For example
Single way total pipe length	≤1000	L1+L2+L3+L4+L5+L6+L7+L8+L9+L10+L11+L12+L13+L14+L15+L16+L17+L18+L19+L20+L21+L22+L23+L24+L25+L26+L27+L28+L29+L30+L31+L32+L33+L34+L35+L36+L37+L38+L39+L40+L41+L42+L43+L44+L45+L46+L47+L48+L49+L50+L51+L52+L53+L54+L55+L56+L57+L58+L59+L60+L61+L62+L63+L64+L65+L66+L67+L68+L69+L70+L71+L72+L73+L74+L75+L76+L77+L78+L79+L80+L81+L82+L83+L84+L85+L86+L87+L88+L89+L90+L91+L92+L93+L94+L95+L96+L97+L98+L99+L100
Pipe length between the first gather pipe to the farthest indoor unit	≤280 ≤130	L1 L1+L2+L3+L4+L5
Pipe length between the first gather pipe and the first branch pipe	≤90**	L1
Pipe length between the first branch pipe and the farthest indoor unit	≤40**	L2+L3+L4+L5
Pipe length between indoor units and the nearest branch pipe	≤40	L4+L5+L6+L7+L8+L9+L10+L11+L12+L13+L14+L15+L16+L17+L18+L19+L20+L21+L22+L23+L24+L25+L26+L27+L28+L29+L30+L31+L32+L33+L34+L35+L36+L37+L38+L39+L40+L41+L42+L43+L44+L45+L46+L47+L48+L49+L50+L51+L52+L53+L54+L55+L56+L57+L58+L59+L60+L61+L62+L63+L64+L65+L66+L67+L68+L69+L70+L71+L72+L73+L74+L75+L76+L77+L78+L79+L80+L81+L82+L83+L84+L85+L86+L87+L88+L89+L90+L91+L92+L93+L94+L95+L96+L97+L98+L99+L100
Pipe length difference between the nearest indoor unit and the farthest indoor unit	≤90**	L2+L3+L4+L5+L6+L7+L8+L9+L10+L11+L12+L13+L14+L15+L16+L17+L18+L19+L20+L21+L22+L23+L24+L25+L26+L27+L28+L29+L30+L31+L32+L33+L34+L35+L36+L37+L38+L39+L40+L41+L42+L43+L44+L45+L46+L47+L48+L49+L50+L51+L52+L53+L54+L55+L56+L57+L58+L59+L60+L61+L62+L63+L64+L65+L66+L67+L68+L69+L70+L71+L72+L73+L74+L75+L76+L77+L78+L79+L80+L81+L82+L83+L84+L85+L86+L87+L88+L89+L90+L91+L92+L93+L94+L95+L96+L97+L98+L99+L100
Height difference between indoor and outdoor units	≤110**	H
Height difference between indoor units	≤30**	H

- \*1. Standard lengths 90m, if >90m, enlarge the pipe diameter as pipe "C" diameter rules.
  - \*2. Standard lengths 40m, if >40m, the pipe between the first branch and the farthest indoor unit need to enlarge one size (refer to pipe "A" & "B" diameter rules).
  - \*3. Standard lengths 15m, if >15m, the pipe between indoor units and the nearest branch pipe need to enlarge one size (refer to pipe "A" diameter rules).
  - \*4. Standard height difference ≤50m, if 50m < height < 70m, need meet following conditions.
    - 1) Indoor rated capacity/outdoor corrected capacity ≤ 130%
    - 2) Set long pipe mode from outdoor PCB.
    - 3) Gas pipe and liquid pipe of main pipe need to enlarge one size, refer to pipe "C" diameter rules.
    - 4) If single way total pipe length > 500m, need to add compressor oil 0.3L/100m (pipe length less than 100m, count as 100m).
- For example, if the total pipe length is 620m, then we should add 0.6L compressor oil. If >70m, please contact the local qualified serviceman or supplier. (If >70m, there is same warning in selection software popping up).

### Three stage cooling

Adopt three-stage subcooling cycle technology

- Three-stage subcooling cycle technology, increased unit efficiency by 9%.
- Maximizing 30°C subcooling, increase unit refrigerating capacity by 46%.

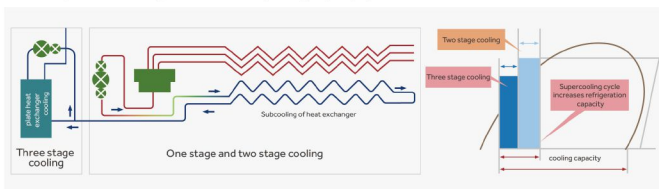

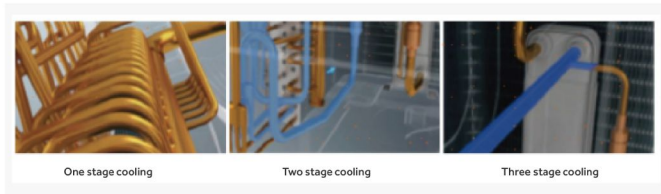

## ADVANCED TECHNOLOGY

### Directly refrigerant cooling PCB

Traditional refrigerant cooling: firstly copper tube cooling fin, then the fin cooling compressor drive module. three layers of heat resistance heat exchange, cause large cold loss.

AQUA directly refrigerant cooling: refrigerant directly into the fin interior, the fin cooling compressor drive module, reduce a layer of heat resistance, under the same operating condition, the temperature of the compressor drive module is lowered by 8°C, to ensure that the whole unit can continue to work under the high temperature of 53°C.

\* Integral design, the heat fin and PCB board fit more closely, high cooling efficiency, there will be no condensation, more safety

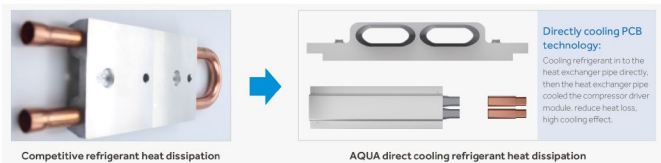

## HIGH EFFICIENCY

### 4 Way heat exchanger



### DC inverter compressor

- Adopt double rotor compressor, high efficiency in low frequency, bring better seasonal energy efficiency
- The efficient oil separation design of the compressor improves the performance of separating oil and refrigerant.
- The compressor adopts the movement of oil pipe design, increase the oil volume, at the same time also suck the oil at the bottom when lack of oil.
- The compressor adopts steel crankshaft (originally cast iron crankshaft) to increase the hardness and reliability, reduce the noise.



## HIGH EFFICIENCY

### DC fan motor

Outdoor unit matches efficient variable-speed DC-motor, driven by sine wave, wider efficiency range and torque range, motor efficiency is increased by 17%, air fan of outdoor unit can achieve 0-91Hz stepless frequency.



### IPLV up to 8.5 (8HP), EER up to 4.82 (8HP)

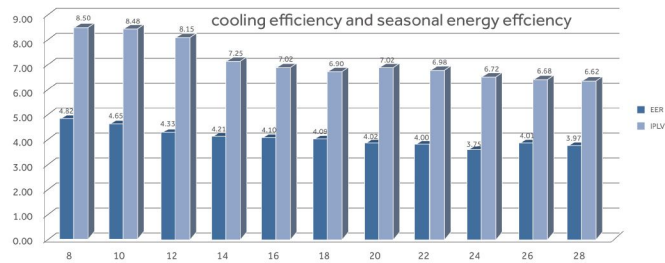

## SUPER COMFORT

### Quick cooling

Start up and reaching maximum output in short time, realize quick cooling.

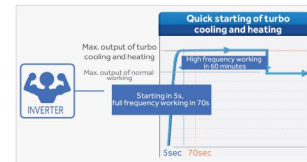

## High temperature performance

Stable performance in high temperature condition, insure the user comfortable experience. the cooling capacity will be reduced only within 5% under the outdoor working condition of 43°C of the whole series products.



AV08NMVQVA  
AV10NMVQVA  
AV12NMVQVA  
AV14NMVQVA  
AV16NMVQVA  
AV18NMVQVA

AV20NMVQVA  
AV22NMVQVA  
AV24NMVQVA  
AV26NMVQVA  
AV28NMVQVA

## EASY INSTALLATION

### Compact electric control box design

Compact electric control box design, compared with MRV 5 heat pump, the electric control box volume reduced by 60%, you can maintenance the compressor, stop valve, sensor and other parts only by opening the front panel.

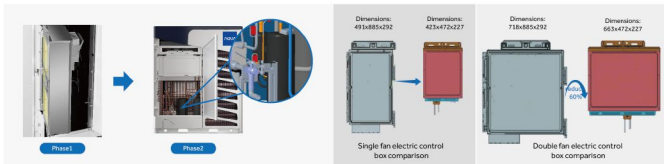

### Large connection ratio



### Smart link

Continues smart link function, easy installation, save labor.



### 3-way pipe connection

You can freely choose the left, front and bottom way connect the pipe, easy installation.



Model		AV08NMVQVA	AV10NMVQVA	AV12NMVQVA	AV14NMVQVA	AV16NMVQVA	AV18NMVQVA		
Model	Combination model	/	/	/	/	/	/		
		/	/	/	/	/	/		
		/	/	/	/	/	/		
		/	/	/	/	/	/		
Capacity	Capacity range	HP	8	10	12	14	16	18	
	Cooling	kW	22.4	28.0	33.5	40.0	45.0	50.0	
Electrical parameters	Power supply	Ph/V/Hz	3/380-415/50/60	3/380-415/50/60	3/380-415/50/60	3/380-415/50/60	3/380-415/50/60	3/380-415/50/60	
	Cooling	Rated power input	kW	4.65	6.02	7.74	9.50	10.98	12.22
		Max power input	kW	11.15	11.53	12.09	15.7	18.42	21.86
		Rated current	A	7.85	10.17	13.06	16.04	18.53	20.64
		Max current	A	18.20	18.91	19.74	26.62	30.32	34.26
	EER		4.82	4.65	4.33	4.21	4.10	4.09	
ISEER		8.5	8.75	8.3	7.4	7.02	7.2		
IPFLV		8.50	8.48	8.15	7.25	7.02	6.90		
Performance	Air flow (H)	m <sup>3</sup> /h	11000	11000	12000	13500	15500	15500	
	Sound pressure level (H-I)	dB(A)	59.0	59.0	59.0	60.0	61.0	62.0	
	Sound power level (H)	dB(A)	73.0	73.0	73.0	74.0	75.0	76.0	
Installation	External dimensions(W/D/H)	mm	980/750/1690						
	Shipping dimensions(W/D/H)	mm	1070/850/1858						
	Net/shipping weight	kg	201/226	201/226	201/226	202/227	220/245	224/249	
	Compressor type		DC INV. Twin-Rotary						
	Compressor brand		MITSUBISHI ELECTRIC						
	Compressor quantity		1INV	1INV	1INV	1INV	1INV	1INV	
	Refrigerant type		R410A	R410A	R410A	R410A	R410A	R410A	
	Refrigerant charge	kg	9	9	9	9	10	10	
	Refrigerant liquid pipe	mm	9.52	9.52	12.70	12.70	12.70	15.88	
	Refrigerant gas pipe	mm	19.05	22.22	25.40	25.40	28.58	28.58	
Max total pipe length	m	1000	1000	1000	1000	1000	1000		
Max pipe length (Equivalent/Actual)	m	260/220	260/220	260/220	260/220	260/220	260/220		
Max drop between LU&OU OU	m	110/90	110/90	110/90	110/90	110/90	110/90		
Standard drop between LU&OU OU (up/down)*2	m	50/40	50/40	50/40	50/40	50/40	50/40		
Max drop between LU *3	m	30	30	30	30	30	30		
Standard drop between LU *4	m	18	18	18	18	18	18		
External static pressure	Pa	110	110	110	110	110	110		
Connection ratio	Connectable indoor unit ratio	%	50-200 with limitation						
	Maximum number of indoor units		20	25	30	36	40	45	
Working temp.	Cooling	°C	-5~53						

# MRV5-C



Total pipe length 1000m,  
height drop 110m



Space saving



Auto addressing  
indoor units



Better cooling capacity

# 3/380~415/50/60



Model		AV20NMVQVA	AV28NMVQVA	AV24NMVQVA	AV26NMVQVA	AV28NMVQVA	AV30NMVQVA	AV32NMVQVA	
Combination model		/	/	/	/	/	AV14NMVQVA	AV16NMVQVA	
		/	/	/	/	/	AV10NMVQVA	AV12NMVQVA	
		/	/	/	/	/	/	/	
Capacity	Capacity range	HP	20	22	24	26	28	30	
	Cooling	kW	56.0	61.5	67.0	73.0	78.0	85.0	
Electrical parameters	Power supply	PhV/Hz	3/380-415/50/60		3/380-415/50/60		3/380-415/50/60		
	Cooling	Rated power input	kW	13.93	15.38	17.87	18.20	19.65	20.5
		Max power input	kW	33.01	33.31	33.64	33.92	34.24	34.1
		Rated current	A	23.52	25.96	30.16	30.73	33.17	34.6
		Max current	A	53.55	54.21	54.70	55.23	55.7	56.9
	EER		4.02	4.00	3.75	4.01	3.97	4.15	4.10
ISEER		7.02	6.98	6.72	6.68	6.62	7.18	7.02	
IPLV		7.02	6.98	6.72	6.68	6.62	7.13	7.00	
Performance	Air flow (H)	m <sup>3</sup> /h	17000	18000	19000	19000	19000	13500-13500	
	Sound pressure level (H)	dB(A)	63.0	63.0	64.0	64.0	64.0	63.5	
	Sound power level (H)	dB(A)	77.0	77.0	78.0	78.0	78.0	77.5	
	External dimensions(W/D/H)	mm	1410/750/1690			1410/750/1690		980/750/1690+980/750/1690	
Shipping dimensions(W/D/H)	mm	1515/850/1858			1515/850/1858		1070/850/1858+1070/850/1858		
Net/shipping weight	kg	310/339	310/339	329/359		329/359	329/359	203/228+220/245	
Compressor type		DC INV. Twin-Rotary			DC INV. Twin-Rotary		DC INV. Twin-Rotary		
Compressor brand		MITSUBISHIELECTRIC			MITSUBISHIELECTRIC		MITSUBISHIELECTRIC		
Compressor quantity		2INV	2INV	2INV	2INV	2INV	1INV+1INV	1INV+1INV	
Refrigerant type		R410A	R410A	R410A	R410A	R410A	R410A	R410A	
Refrigerant charge	kg	10	10	10	10	10	9+10	10+10	
Installation	Refrigerant liquid pipe	mm	15.88	15.88	15.88	15.88	19.05	19.05	
	Refrigerant gas pipe	mm	28.58	28.58	28.58	28.58	31.75	31.75	
	Max.total pipe length	m	1000	1000	1000	1000	1000	1000	
	Max. pipe length(Equivalent/Actual)	m	260/220	260/220	260/220	260/220	260/220	260/220	
	Max drop between U.S.O.U/O.U	m	110/90	110/90	110/90	110/90	110/90	110/90	
	Standard drop between U.S.O.U/O.U	mm	50/40	50/40	50/40	50/40	50/40	50/40	
	Max drop between LU *3	m	30	30	30	30	30	30	
	Standard drop between LU *4	m	18	18	18	18	18	18	
External static pressure	Pa	110	110	110	110	110	110		
Connection ratio	Connectable indoor unit ratio	%	50-200 with limitation			50-200 with limitation		50-150 with limitation	
	Maximum number of indoor units		50	55	60	64	64	64	
Working temp.	Cooling	°C	-5-53			-5-53			



AV20NMVQVA  
AV10NMVQVA  
AV12NMVQVA  
AV14NMVQVA  
AV16NMVQVA  
AV18NMVQVA



AV28NMVQVA  
AV22NMVQVA  
AV24NMVQVA  
AV26NMVQVA  
AV28NMVQVA

Max drop between U.S.O.U/O.U \*1  
Standard drop between U.S.O.U/O.U \*2  
Max drop between LU \*3  
Standard drop between LU \*4  
\*All the specifications are based on standard conditions (cooling indoor temp. 27°C DB/19°C WB/Outdoor temp. 35°C DB/24°C WB)

If the height difference between the outdoor and the indoor units is from 50 to 110m, you MUST contact your local distributor/dealer for individual design and production.  
Standard design and production in the factory.  
If the height difference between the indoor units is from 18 to 30m, you MUST contact your local distributor/dealer for individual design and production.  
Standard design and production in the factory.  
Standard design and production in the factory.

# MRV5-C



Total pipe length 1000m,  
height drop 110m



Space saving



Auto addressing  
indoor units



Better cooling capacity

# 3/380~415/50/60

Model		AV14NMVQVA AV16NMVQVA	AV36NMVQVA AV18NMVQVA	AV38NMVQVA AV18NMVQVA	AV40NMVQVA AV20NMVQVA	AV42NMVQVA AV20NMVQVA	AV44NMVQVA AV22NMVQVA
Combination model		AV18NMVQVA	AV18NMVQVA	AV20NMVQVA	AV20NMVQVA	AV22NMVQVA	AV22NMVQVA
		/	/	/	/	/	/
Capacity range		34	36	38	40	42	44
Cooling		95.0	100.0	106.0	112.0	117.5	123.0
Power supply		3/380-415/50/60	3/380-415/50/60	3/380-415/50/60	3/380-415/50/60	3/380-415/50/60	3/380-415/50/60
Electrical parameters							
Cooling							
Rated power input		23.2	24.4	26.2	27.9	29.3	30.8
Max power input		40.3	43.7	54.9	66.0	66.3	66.6
Rated current		39.2	41.3	44.2	47.0	49.5	51.9
Max current		64.6	68.5	87.8	107.1	107.8	108.4
EER		4.09	4.09	4.05	4.02	4.01	4.00
ISEER		7.11	7.20	7.09	6.99	6.96	6.93
IPLV		6.95	6.90	7.02	7.13	7.06	6.99
Performance							
Air flow (H)		13500+13500	13500+13500	13500+17000	17000+17000	17000+18000	18000+18000
Sound pressure level (H)		64.5	65.0	65.5	66.0	66.0	66.0
Sound power level (H)		78.5	79.0	79.5	80.0	80.0	80.0
External dimensions(W/D/H)		980/750/1690-980/750/1690		980/750/1690+1410/750/1690			
Shipping dimensions(W/D/H)		1070/850/1858-1515/850/1858		1515/850/1858-1515/850/1858			
Net/shipping weight		220/245+224/249	224/249+224/249	224/249+310/339	310/339+310/339	310/339+310/339	310/339+310/339
Compressor type		DC IN.V. Twin-Rotary			DC IN.V. Twin-Rotary		
Compressor brand		MITSUBISHI-ELECTRIC			MITSUBISHI-ELECTRIC		
Compressor quantity		1INV+1INV	1INV+1INV	1INV+2INV	2INV+2INV	2INV+2INV	2INV+2INV
Refrigerant type		R410A	R410A	R410A	R410A	R410A	R410A
Refrigerant charge		10+10	10+10	10+10	10+10	10+10	10+10
Installation							
Refrigerant liquid pipe		19.05	19.05	19.05	19.05	19.05	19.05
Refrigerant gas pipe		31.75	38.1	38.1	38.1	38.1	38.1
Max.total pipe length		1000	1000	1000	1000	1000	1000
Max. pipe length(Equivalent/Actual)		260/220	260/220	260/220	260/220	260/220	260/220
Max drop between U.S.O.U / O.U down(m) *1		110/90	110/90	110/90	110/90	110/90	110/90
Standard drop between U.S.O.U / O.U up/down) *2		50/40	50/40	50/40	50/40	50/40	50/40
Max drop between LU *3		30	30	30	30	30	30
Standard drop between LU *4		18	18	18	18	18	18
External static pressure		Pa	110	110	110	110	110
Connection ratio		% 50-150 with limitation			% 50-150 with limitation		
Maximum number of indoor units		64	64	64	64	64	64
Working temp.		Cooling		°C		-5-53	



AV08NMVQVA  
AV10NMVQVA  
AV12NMVQVA  
AV14NMVQVA  
AV16NMVQVA  
AV18NMVQVA



AV20NMVQVA  
AV22NMVQVA  
AV24NMVQVA  
AV26NMVQVA  
AV28NMVQVA

Max drop between U.S.O.U \*1  
Standard drop between U.S.O.U \*2  
Max drop between LU \*3  
Standard drop between LU \*4  
\*All the specifications are tested under normal condition (cooling indoor temp. 27°C DB/21°C WB/Outdoor temp 35°C DB/24WB).  
\*If the height difference between the outdoor and the indoor units is from 30 to 110m, you MUST contact your local distributor/leader for individual design and production.  
\*If the height difference between the outdoor and the indoor units is from 18 to 30m, you MUST contact your local distributor/leader for individual design and production.  
\*If the height difference between the indoor units is from 18 to 30m, you MUST contact your local distributor/leader for individual design and production.

# MRV5-C



Total pipe length 1000m,  
height drop 110m



Space saving



Auto addressing  
indoor units



Better cooling capacity

# 3/380~415/50/60

Model	AV46NMVQVA AV22NMVQVA	AV48NMVQVA AV24NMVQVA	AV50NMVQVA AV26NMVQVA	AV52NMVQVA AV28NMVQVA	AV56NMVQVA AV26NMVQVA	AV58NMVQVA AV28NMVQVA		
Combination model	AV22NMVQVA	AV24NMVQVA	AV26NMVQVA	AV28NMVQVA	AV26NMVQVA	AV28NMVQVA		
	/	/	/	/	/	/		
	/	/	/	/	/	/		
Capacity	Capacity range	HP 46	HP 48	HP 50	HP 52	HP 54	HP 56	
	Cooling	kW 128.5	kW 134.0	kW 140.0	kW 146.0	kW 151.0	kW 156.0	
	Power supply	PHV/Hz 3/380-415/50/60	3/380-415/50/60	3/380-415/50/60	3/380-415/50/60	3/380-415/50/60	3/380-415/50/60	
Electrical parameters	Cooling	Rated power input	kW 33.2	kW 35.7	kW 36.1	kW 36.4	kW 37.9	kW 39.3
		Max power input	kW 67.0	kW 67.3	kW 67.6	kW 67.8	kW 68.2	kW 68.5
		Rated current	A 56.3	A 60.3	A 60.9	A 61.5	A 63.9	A 66.3
		Max current	A 108.9	A 109.4	A 109.9	A 110.5	A 110.9	A 111.4
		EER	3.87	3.75	3.88	4.01	3.99	3.97
	ISEER	6.81	6.69	6.67	6.65	6.62	6.60	
IPLV	6.84	6.70	6.70	6.71	6.68	6.65		
Performance	Air flow (H)	m <sup>3</sup> /h 18000+19000	19000+19000	19000+19000	19000+19000	19000+19000	19000+19000	
	Sound pressure level (H)	dB(A) 66.5	dB(A) 67.0	dB(A) 67.0	dB(A) 67.0	dB(A) 67.0	dB(A) 67.0	
	Sound power level (H)	dB(A) 80.5	dB(A) 81.0	dB(A) 81.0	dB(A) 81.0	dB(A) 81.0	dB(A) 81.0	
	External dimensions(W/D/H)	mm 1410/750/1690-1410/750/1690		mm 1410/750/1690-1410/750/1690				
	Shipping dimensions(W/D/H)	mm 1515/850/1858-1515/850/1858		mm 1515/850/1858-1515/850/1858				
Net/shipping weight	kg 310/339+329/359	329/359+329/359	329/359+329/359	329/359+329/359	329/359+329/359	329/359+329/359		
Compressor type	DC INV. Twin-Rotary			DC INV. Twin-Rotary				
Compressor brand	MITSUBISHIELECTRIC			MITSUBISHIELECTRIC				
Compressor quantity	2INV+2INV	2INV+2INV	2INV+2INV	2INV+2INV	2INV+2INV	2INV+2INV		
Refrigerant type	R410A	R410A	R410A	R410A	R410A	R410A		
Refrigerant charge	kg 10+10	kg 10+10	kg 10+10	kg 10+10	kg 10+10	kg 10+10		
Installation	Refrigerant liquid pipe	mm 19.05	mm 19.05	mm 19.05	mm 19.05	mm 19.05	mm 19.05	
	Refrigerant gas pipe	mm 38.1	mm 38.1	mm 38.1	mm 38.1	mm 38.1	mm 38.1	
	Max total pipe length	m 1000	m 1000	m 1000	m 1000	m 1000	m 1000	
	Max pipe length (Equivalent/Actual)	m 260/220	m 260/220	m 260/220	m 260/220	m 260/220	m 260/220	
	Max drop between U.O.U/O.U down (up) *1	m 110/90	m 110/90	m 110/90	m 110/90	m 110/90	m 110/90	
	Standard drop between U.O.U/O.U up/down) *2	m 50/40	m 50/40	m 50/40	m 50/40	m 50/40	m 50/40	
	Max drop between LU *3	m 30	m 30	m 30	m 30	m 30	m 30	
	Standard drop between LU *4	m 18	m 18	m 18	m 18	m 18	m 18	
	External static pressure	Pa 110	Pa 110	Pa 110	Pa 110	Pa 110	Pa 110	
Connection ratio	Connectable indoor unit ratio	% 50-150 with limitation			% 50-150 with limitation			
	Maximum number of indoor units	64	64	64	64	64	64	
Working temp.	Cooling	°C -5~53			°C -5~53			



AV08NMVQVA  
AV10NMVQVA  
AV12NMVQVA  
AV14NMVQVA  
AV16NMVQVA  
AV18NMVQVA



AV20NMVQVA  
AV22NMVQVA  
AV24NMVQVA  
AV26NMVQVA  
AV28NMVQVA

Max drop between U.O.U \*1  
Standard drop between U.O.U/O.U \*2  
Max drop between LU \*3  
Standard drop between LU \*4  
\* All the specifications are tested under normal conditions (cooling indoor temp. is 27°C DB/19°C WB; outdoor temp. 35°C DB/24°C WB)

If the height difference between the outdoor and the indoor units is from 50 to 120m, you MUST contact your local distributor/dealer for individual design and production.  
If the height difference between the outdoor and the indoor units is from 18 to 50m, you MUST contact your local distributor/dealer for individual design and production.  
Standard design and production in the factory.

# MRV5-C

DC INVERTER



Total pipe length 1000m,  
height drop 110m



Space saving



Auto addressing  
indoor units



Better cooling capacity

# 3/380~415/50/60



Model		AV58NMVQVA AV18NMVQVA	AV20NMVQVA AV20NMVQVA	AV62NMVQVA AV20NMVQVA	AV64NMVQVA AV20NMVQVA	AV66NMVQVA AV22NMVQVA	AV68NMVQVA AV22NMVQVA	
Combination model		AV20NMVQVA AV20NMVQVA	AV20NMVQVA AV20NMVQVA	AV20NMVQVA AV22NMVQVA	AV22NMVQVA AV22NMVQVA	AV22NMVQVA AV22NMVQVA	AV24NMVQVA AV24NMVQVA	
		/	/	/	/	/	/	
Capacity	Capacity range	HP 58	60	62	64	66	68	
	Cooling	kW 162.0	168.0	173.5	179.0	184.5	190.0	
	Power supply	PHV/Hz 3/380-415/50/60	3/380-415/50/60	3/380-415/50/60	3/380-415/50/60	3/380-415/50/60	3/380-415/50/60	
Electrical parameters	Cooling	Rated power input	kW 40.1	41.8	43.2	44.7	46.1	
		Max power input	kW 87.9	99.0	99.3	99.6	99.9	100.3
		Rated current	A 67.7	70.6	73.0	75.4	77.9	82.1
	EER	Max current	A 141.4	160.7	161.3	162.0	162.6	163.1
		EER	4.04	4.02	4.01	4.01	4.00	3.91
		ISEER	7.05	6.99	6.95	6.97	6.95	6.85
IPLV	7.06	7.13	7.08	7.04	6.99	6.89		
Performance	Air flow (H)	m <sup>3</sup> /h 13500-17000-17000	17000-17000-17000	17000+17000-18000	17000+18000-18000	18000+18000-18000	18000+18000-19000	
	Sound pressure level (H)	dB(A) 67.5	67.5	67.5	67.5	67.5	68.0	
	Sound power level (H)	dB(A) 81.5	81.5	81.5	81.5	81.5	82.0	
	External dimensions(W/D/H)	mm 980/790/1690-1410/750/1690+1410/750/1690	1410/750/1690+1410/750/1690+1410/750/1690					
	Shipping dimensions(W/D/H)	mm 1070/850/1858-1515/850/1858+1858/1858+1515/850/1858	1515/850/1858+1515/850/1858+1515/850/1858					
	Net/shipping weight	kg 224/249-310/339+310/339	310/339-310/339+310/339					
Compressor type		DC INV. Twin-Rotary			DC INV. Twin-Rotary			
Compressor brand		MITSUBISHI-ELECTRIC			MITSUBISHI-ELECTRIC			
Compressor quantity		1INV+2INV+2INV		2INV+2INV+2INV	2INV+2INV+2INV	2INV+2INV+2INV	2INV+2INV+2INV	
Refrigerant type		R410A		R410A	R410A	R410A	R410A	
Refrigerant charge		kg 10+10+10		10+10+10	10+10+10	10+10+10	10+10+10	
Installation	Refrigerant liquid pipe	mm 19.05	19.05	19.05	19.05	19.05	22.2	
	Refrigerant gas pipe	mm 41.3	41.3	41.3	41.3	41.3	44.5	
	Max total pipe length	m 1000	1000	1000	1000	1000	1000	
	Max pipe length (Equivalent/Actual)	m 260/220	260/220	260/220	260/220	260/220	260/220	
	Max drop between U.O.U/O.U	m 110/90	110/90	110/90	110/90	110/90	110/90	
	Standard drop between U.O.U/O.U (up/down) *1	m 50/40	50/40	50/40	50/40	50/40	50/40	
	Standard drop between U.O.U/O.U (up/down) *2	m 50/40	50/40	50/40	50/40	50/40	50/40	
	Max drop between LU *3	m 30	30	30	30	30	30	
	Standard drop between LU *4	m 18	18	18	18	18	18	
	External static pressure	Pa 110	110	110	110	110	110	
Connection ratio	Connectable indoor unit ratio	% 50-130 with limitation			% 50-130 with limitation			
	Maximum number of indoor units	64			64			
Working temp.	Cooling	°C -5-53			°C -5-53			



AV08NMVQVA  
AV10NMVQVA  
AV12NMVQVA  
AV14NMVQVA  
AV16NMVQVA  
AV18NMVQVA



AV20NMVQVA  
AV22NMVQVA  
AV24NMVQVA  
AV26NMVQVA  
AV28NMVQVA

\*1 Max drop between U.O.U/O.U  
\*2 Standard drop between U.O.U/O.U  
\*3 Max drop between LU  
\*4 Standard drop between LU  
\*5 Max drop between U.O.U/O.U  
\*6 Standard drop between U.O.U/O.U  
\*7 All the specifications are based on standard conditions (cooling indoor temp. 27°C DB/31°C WB/Outdoor temp. 35°C DB/65°F)

# DC INVERTER MRV5-C



Total pipe length 1000m,  
height drop 110m



Space saving



Auto addressing  
indoor units



Better cooling capacity

# 3/380~415/50/60



Model	AV72NMVQVA		AV72NMVQVA		AV72NMVQVA		AV72NMVQVA		AV72NMVQVA	
	AV22NMVQVA		AV24NMVQVA		AV24NMVQVA		AV24NMVQVA		AV24NMVQVA	
Combination model	AV24NMVQVA		AV24NMVQVA		AV24NMVQVA		AV24NMVQVA		AV24NMVQVA	
	AV24NMVQVA		AV24NMVQVA		AV24NMVQVA		AV24NMVQVA		AV24NMVQVA	
	AV24NMVQVA		AV24NMVQVA		AV24NMVQVA		AV24NMVQVA		AV24NMVQVA	
Capacity	Capacity range	HP	70	72	74	76	78	80		
	Cooling	kW	195.5	201.0	207.0	213.0	219.0	224.0		
	Power supply	PhV/Hz	3/380-415/50/60		3/380-415/50/60		3/380-415/50/60		3/380-415/50/60	
Electrical parameters	Cooling	Rated power input	kW	51.1	53.6	55.9	54.3	54.6	56.1	
		Max power input	kW	100.6	100.9	101.2	101.5	101.8	102.1	
		Rated current	A	86.3	90.5	91.1	91.6	92.2	94.6	
		Max current	A	163.6	164.1	164.6	165.2	165.7	166.2	
		EER		3.82	3.75	3.84	3.92	4.01	4.00	
	ISEER		6.77	6.69	6.68	6.66	6.65	6.63		
IPLV		6.79	6.70	6.70	6.71	6.71	6.69			
Performance	Air flow (H)	m <sup>3</sup> /h	18000+19000-19000	19000-19000+19000	19000+19000+19000	19000+19000+19000	19000+19000-19000	19000+19000+19000		
	Sound pressure level (H)	dB(A)	68.5	68.5	68.5	68.5	68.5	68.5		
	Sound power level (H)	dB(A)	82.5	82.5	82.5	82.5	82.5	82.5		
Installation	External dimensions(W/D/H)	mm	1410/750/1690-1410/750/1690-1410/750/1690				1410/750/1690+1410/750/1690+1410/750/1690			
	Shipping dimensions(W/D/H)	mm	1515/850/1858+1515/850/1858-1515/850/1858				1515/850/1858+1515/850/1858+1515/850/1858			
	Net/shipping weight	kg	310/359+329/359+329/359				329/359+329/359+329/359			
	Compressor type		DC INV. Twin-Rotary				DC INV. Twin-Rotary			
	Compressor brand		MITSUBISHI ELECTRIC				MITSUBISHI ELECTRIC			
	Compressor quantity		2INV+2INV+2INV	2INV+2INV+2INV	2INV+2INV+2INV	2INV+2INV+2INV	2INV+2INV+2INV	2INV+2INV+2INV	2INV+2INV+2INV	
	Refrigerant type		R410A	R410A	R410A	R410A	R410A	R410A		
	Refrigerant charge	kg	10+10+10	10+10+10	10+10+10	10+10+10	10+10+10	10+10+10		
	Refrigerant liquid pipe	mm	22.2	22.2	22.2	22.2	22.2	22.2		
	Refrigerant gas pipe	mm	44.5	44.5	44.5	44.5	44.5	44.5		
Connection ratio	Max total pipe length	m	1000	1000	1000	1000	1000	1000		
	Max pipe length(Equivalent/Actual)	m	260/220	260/220	260/220	260/220	260/220	260/220		
	Max drop between LU & LU/O.U	m	110/90	110/90	110/90	110/90	110/90	110/90		
	Standard drop between LU & LU/O.U (down)*1	m	50/40	50/40	50/40	50/40	50/40	50/40		
	Standard drop between LU & LU/O.U (up/down)*2	m	50/40	50/40	50/40	50/40	50/40	50/40		
	Max drop between LU *3	m	30	30	30	30	30	30		
	Standard drop between LU *4	m	18	18	18	18	18	18		
	External static pressure	Pa	110	110	110	110	110	110		
	Connectable indoor unit ratio	%	50-130 with limitation				50-130 with limitation			
	Maximum number of indoor units		64	64	64	64	64	64		
Working temp.	Cooling	°C	-5~53		-5~53		-5~53		-5~53	



AV08NMVQVA  
AV10NMVQVA  
AV12NMVQVA  
AV14NMVQVA  
AV16NMVQVA  
AV18NMVQVA



AV26NMVQVA  
AV22NMVQVA  
AV24NMVQVA  
AV26NMVQVA  
AV28NMVQVA

Max. dr. between LU & LU: \*1  
Standard drop between LU & LU: \*2  
Max. dr. between LU: \*3  
Standard drop between LU: \*4  
\*If the height difference between the outdoor and the indoor units is from 18 to 110m, you MUST contact your local distributor/dealer for individual design and production.  
\*If the height difference between the indoor units is from 18 to 110m, you MUST contact your local distributor/dealer for individual design and production.  
\*If the height difference between the indoor units is from 18 to 110m, you MUST contact your local distributor/dealer for individual design and production.  
\*All the specifications are tested under normal condition (cooling indoor temp. is 27°C DB/19°C WB/Outdoor temp. 35°C DB/24°C WB).

# MRV5-C



Total pipe length: 1000m,  
height drop 110m



Space saving



Auto addressing  
indoor units



Better cooling capacity

# 3/380~415/50/60



Model		AV28NMVQVA	AV48NMVQVA	AV88NMVQVA	AV28NMVQVA	AV22NMVQVA	AV90NMVQVA	
Combination model		AV28NMVQVA	AV28NMVQVA	AV20NMVQVA	AV22NMVQVA	AV22NMVQVA	AV22NMVQVA	
		AV28NMVQVA	AV28NMVQVA	AV22NMVQVA	AV22NMVQVA	AV22NMVQVA	AV22NMVQVA	
		AV28NMVQVA	AV28NMVQVA	AV22NMVQVA	AV22NMVQVA	AV22NMVQVA	AV22NMVQVA	
		/	/	AV22NMVQVA	AV22NMVQVA	AV22NMVQVA	AV24NMVQVA	
Capacity	Capacity range	HP	82	84	85	88	90	
	Cooling	kW	229.0	234.0	240.5	246.0	251.5	
	Power supply	PhV/Hz	3/380~415/50/60	3/380~415/50/60	3/380~415/50/60	3/380~415/50/60	3/380~415/50/60	
Electrical parameters	Cooling	Rated power input	kW	57.5	58.9	60.1	61.5	64.0
		Max power input	kW	102.4	102.7	132.9	133.2	133.6
		Rated current	A	97.1	99.5	101.4	103.8	108.0
	EER	Max current	A	166.6	167.1	216.2	216.8	217.3
		EER		3.98	3.97	4.00	4.00	3.93
	ISEER		6.61	6.60	6.95	6.93	6.87	
	IPLV		6.67	6.65	7.03	6.99	6.91	
Performance	Air flow (H)	m <sup>3</sup> /h	19000~19000~19000	19000~18000~19000	17000~18000~18000	18000~18000~18000	18000~18000~19000	
	Sound pressure level (H)	dB(A)	68.5	68.5	69.0	69.0	69.0	
	Sound power level (H)	dB(A)	82.5	82.5	82.5	82.5	83.0	
	External dimensions(W/D/H)	mm	1410/750/1690*1410/750/1690~1410/750/1690		1410/750/1690~1410/750/1690~1410/750/1690~1410/750/1690			
	Shipping dimensions(W/D/H)	mm	1515/850/1858~1515/850/1858~1515/850/1858		1515/850/1858~1515/850/1858~1515/850/1858~1515/850/1858			
	Net/shipping weight	kg	329/359~329/359~329/359		310/339~310/339~310/339~310/339			
	Compressor type		DC INV. Twin-Rotary			DC INV. Twin-Rotary		
Compressor brand		MITSUBISHI-ELECTRIC			MITSUBISHI-ELECTRIC			
Compressor quantity		2INNV+2INV+2INV		2INV+2INV+2INV		2INV+2INV+2INV+2INV		
Refrigerant type		R410A		R410A		R410A		
Refrigerant charge	kg	10~10~10		10~10~10~10		10~10~10~10		
Installation	Refrigerant liquid pipe	mm	22.2		25.4		25.4	
	Refrigerant gas pipe	mm	44.5		50.8		50.8	
	Max.total pipe length	m	1000		1000		1000	
	Max. pipe length(Equivalent/Actual)	m	260/220		260/220		260/220	
	Max drop between U.S.O.U (O.U down/up)*1	m	110/90		110/90		110/90	
	Standard drop between U.S.O.U (O.U up/down)*2	m	50/40		50/40		50/40	
	Max drop between LU*3	m	30		30		30	
	Standard drop between LU*4	m	18		18		18	
	External static pressure	Pa	110		110		110	
	Connectable indoor unit ratio	%	50~130 with limitation			50~130 with limitation		
Connection ratio	Maximum number of indoor units	64		64		64		
	Cooling	°C	-5~53		-5~53		-5~53	
Working temp.								



AV08NMVQVA  
AV10NMVQVA  
AV12NMVQVA  
AV14NMVQVA  
AV16NMVQVA  
AV18NMVQVA



AV28NMVQVA  
AV22NMVQVA  
AV24NMVQVA  
AV26NMVQVA  
AV28NMVQVA

Max drop between U.S.O.U \*1  
Standard drop between U.S.O.U \*2  
Max drop between LU \*3  
Standard drop between LU \*4

\*If the height difference between the outdoor and the indoor units is from 50m to 110m, you MUST contact your local distributor/dealer for individual design and production.  
\*If the height difference between the outdoor units is from 18 to 30m, you MUST contact your local distributor/dealer for individual design and production.  
\*The specifications are based on the nominal condition (cooling indoor temp. is 27°C DB/19°C WB; outdoor temp. 35°C DB/24°C WB).

# MRV5-C



Total pipe length 1000m,  
height drop 110m



Space saving



Auto addressing  
indoor units



Better cooling capacity

# 3/380~415/50/60



Model		AV92NMVQVA	AV94NMVQVA	AV96NMVQVA	AV98NMVQVA	AV100NMVQVA		
Combination model		AV22NMVQVA	AV22NMVQVA	AV24NMVQVA	AV24NMVQVA	AV24NMVQVA		
		AV22NMVQVA	AV24NMVQVA	AV24NMVQVA	AV24NMVQVA	AV24NMVQVA		
		AV24NMVQVA	AV24NMVQVA	AV24NMVQVA	AV24NMVQVA	AV26NMVQVA		
		AV24NMVQVA	AV24NMVQVA	AV24NMVQVA	AV26NMVQVA	AV26NMVQVA		
		AV24NMVQVA	AV24NMVQVA	AV24NMVQVA	AV26NMVQVA	AV26NMVQVA		
Capacity	Capacity range	HP	92	94	96	100		
	Cooling	kW	257.0	262.5	268.0	274.0		
	Power supply	PhV/Hz	3/380-415/50/60	3/380-415/50/60	3/380-415/50/60	3/380-415/50/60	3/380-415/50/60	
Electrical parameters	Cooling	Rated power input	kW	66.5	69.0	71.5	71.8	72.1
		Max power input	kW	133.9	134.2	134.6	134.8	135.1
		Rated current	A	112.2	116.4	120.7	121.2	121.8
		Max current	A	217.8	218.3	218.8	219.3	219.9
	EER		3.87	3.81	3.75	3.82	3.88	
	ISEER		6.81	6.75	6.69	6.68	6.67	
IPLV		6.84	6.77	6.70	6.70	6.70		
Performance	Air flow (H)	m <sup>3</sup> /h	18000+18000+19000+19000	18000+19000+19000+19000	19000+19000+19000+19000	19000+19000+19000+19000	19000+19000+19000+19000	
	Sound pressure level (H)	dB(A)	69.5	69.5	70.0	70.0	70.0	
	Sound power level (H)	dB(A)	83.5	83.5	84.0	84.0	84.0	
	External dimensions(W/D/H)	mm						1410/750/1690+1410/750/1690+1410/750/1690+1410/750/1690
	Shipping dimensions(W/D/H)	mm						1515/850/1858+1515/850/1858+1515/850/1858+1515/850/1858
	Net/shipping weight	kg	310/339+310/339+329/359+329/359	310/339+329/359+329/359+329/359	329/359+329/359+329/359+329/359			
Installation	Compressor type	DC INV. Twin-Rotary			DC INV. Twin-Rotary			
	Compressor brand	MITSUBISHI ELECTRIC			MITSUBISHI ELECTRIC			
	Compressor quantity				2IN1V+2IN1V+2IN1V+2IN1V			
	Refrigerant type	R410A		R410A	R410A	R410A	R410A	
	Refrigerant charge	kg	10+10+10+10	10+10+10+10	10+10+10+10	10+10+10+10	10+10+10+10	
	Refrigerant liquid pipe	mm	25.4	25.4	25.4	25.4	25.4	
	Refrigerant gas pipe	mm	50.8	50.8	50.8	54.1	54.1	
	Max. total pipe length	m	1000	1000	1000	1000	1000	
	Max. pipe length (Equivalent/Actual)	m	260/220	260/220	260/220	260/220	260/220	
	Max drop between LU&OU (O.U. down) *1	m	110/90	110/90	110/90	110/90	110/90	
	Standard pipe between U.&O (U.O. up/down) *2	m	50/40	50/40	50/40	50/40	50/40	
	Max drop between LU *3	m	30	30	30	30	30	
	Standard drop between LU *4	m	18	18	18	18	18	
	External static pressure	Pa	110	110	110	110	110	
Connection ratio	Connectable indoor unit ratio	%	50-130 with limitation	50-130 with limitation				
Working temp.	Maximum number of indoor units		64	64	64	64		
	Cooling	°C	-5-53			-5-53		



AV08NMVQVA  
AV10NMVQVA  
AV12NMVQVA  
AV14NMVQVA  
AV16NMVQVA  
AV18NMVQVA



AV26NMVQVA  
AV22NMVQVA  
AV24NMVQVA  
AV26NMVQVA  
AV28NMVQVA

Max drop between LU&OU \*1  
Standard design and production in the factory.  
Max drop between LU \*3  
Standard design and production in the factory.  
Standard pipe between LU \*4  
All the specifications are based on standard conditions (cooling indoor temp. is 27°C DB/19°C WB; outdoor temp. 35°C DB/24°C WB).

\* If the height difference between the outdoor and the indoor units is from 30 to 120m, you MUST contact your local distributor/leader for individual design and production.  
\* If the height difference between the outdoor and the indoor units is from 18 to 30m, you MUST contact your local distributor/leader for individual design and production.  
\* Standard design and production in the factory.

# MRV5-C

DC INVERTER



Total pipe length 1000m,  
height drop 110m



Space saving



Auto addressing  
indoor units



Better cooling capacity

# 3/380~415/50/60



Model	AV102NMVQVA AV24NMVQVA AV28NMVQVA AV28NMVQVA AV28NMVQVA		AV104NMVQVA AV26NMVQVA AV26NMVQVA AV26NMVQVA AV26NMVQVA		AV106NMVQVA AV26NMVQVA AV26NMVQVA AV26NMVQVA AV26NMVQVA		AV108NMVQVA AV26NMVQVA AV26NMVQVA AV26NMVQVA AV26NMVQVA		AV110NMVQVA AV26NMVQVA AV26NMVQVA AV26NMVQVA AV26NMVQVA		AV112NMVQVA AV26NMVQVA AV26NMVQVA AV26NMVQVA AV26NMVQVA		
Capacity	Capacity range	HP	102		104		106		108		110		
	Cooling	kW	286.0		292.0		297.0		302.0		307.0		
Electrical parameters	Power supply	Ph/V/Hz	3/380-415/50/60		3/380-415/50/60		3/380-415/50/60		3/380-415/50/60		3/380-415/50/60		
	Cooling	Rated power input	kW	72.5		72.8		74.3		75.7		77.1	
		Max power input	kW	135.4		135.7		136.0		136.3		136.6	
		Rated current	A	122.4		122.9		125.4		127.8		130.2	
		Max current	A	220.4		220.9		221.4		221.9		222.3	
		EER		3.95		4.01		4.00		3.99		3.98	
ISEER		6.66		6.65		6.64		6.62		6.61			
IPLV		6.71		6.71		6.69		6.68		6.67			
Performance	Air flow (H)	m <sup>3</sup> /h	19000+19000-15000+19000		19000+19000-19000+19000		19000+19000-19000-19000		19000+19000-19000+19000		19000+19000-19000+19000		
	Sound pressure level (H)	dB(A)	70.0		70.0		70.0		70.0		70.0		
	Sound power level (H)	dB(A)	84.0		84.0		84.0		84.0		84.0		
	External dimensions(W/D/H)	mm	1410/750/1690+1410/750/1690+1410/750/1690+1410/750/1690+1410/750/1690										
	Shipping dimensions(W/D/H)	mm	1515/850/1858+1515/850/1858+1515/850/1858+1515/850/1858+1515/850/1858										
	Net/shipping weight	kg	329/359+329/359+329/359+329/359										
	Compressor type		DC INV. Twin-Rotary				DC INV. Twin-Rotary						
	Compressor brand		MITSUBISHI ELECTRIC				MITSUBISHI ELECTRIC						
	Compressor quantity						2INV+2INV+2INV+2INV						
	Refrigerant type		R410A		R410A		R410A		R410A		R410A		
Refrigerant charge	kg	10+10+10+10		10+10+10+10		10+10+10+10		10+10+10+10		10+10+10+10			
Installation	Refrigerant liquid pipe	mm	25.4		25.4		28.58		28.58		28.58		
	Refrigerant gas pipe	mm	54.1		54.1		66.70		66.70		66.70		
	Max.total pipe length	m	1000		1000		1000		1000		1000		
	Max. pipe length (Equivalent/Actual)	m	260/220		260/220		260/220		260/220		260/220		
	Max drop between (U&O/U/O.U. down/up) *1	m	110/90		110/90		110/90		110/90		110/90		
	Standard drop between (U&O/U/O.U. up/down) *2	m	50/40		50/40		50/40		50/40		50/40		
	Max drop between LU *3	m	30		30		30		30		30		
	Standard drop between LU *4	m	18		18		18		18		18		
	External static pressure	Pa	110		110		110		110		110		
	Connectable indoor unit ratio	%	50-130 with limitation				50-130 with limitation						
Connection ratio	Maximum number of indoor units		64		64		64		64		64		
	Working temp.	Cooling	°C		-5-53						-5-53		



AV08NMVQVA  
AV10NMVQVA  
AV12NMVQVA  
AV14NMVQVA  
AV16NMVQVA  
AV18NMVQVA



AV26NMVQVA  
AV28NMVQVA  
AV26NMVQVA  
AV26NMVQVA  
AV28NMVQVA

Max drop between (U&O/U) \*1  
Standard drop between (U&O/U) \*2  
Max drop between LU \*3  
Standard drop between LU \*4

If the height difference between the outdoor and the indoor units is from 50 to 130m, you MUST contact your local distributor/dealer for individual design and production.  
Standard drop and production in the factory.  
If the height difference between the outdoor units is from 18 to 50m, you MUST contact your local distributor/dealer for individual design and production.  
Standard drop and production in the factory.

\* All the specifications are based on standard nominal conditions (cooling indoor temp. is 27°C DB/Outdoor temp 35°C DB/DBWB).



# MRV S<sup>II</sup>

**079** Features & Benefits

**084** MRV SII Outdoor

**088** Dimensions



# MRV S II

-  Advanced Technology
-  High Efficiency
-  Super Comfort
-  Easy Installation
-  High Reliability

## ADVANCED TECHNOLOGY

### Leadership in technology(4-6HP)

- Two-stage supercooling cycle technology, increased unit efficiency by 9% (Double fan)
- Maximizing 30°C undercooling, increase unit refrigerating capacity by 46%.



## ADVANCED TECHNOLOGY

### Increasing enthalpy by replenish gas, realize the unit powerful heating capacity

Taking the heating cycle as an example, when environment temperature is low, heat exchanged capability of outdoor unit is depressed, the amount of air returned by compressor is reduced. Increase the amount of refrigerant in the heating cycle of the indoor unit heat exchanger, thereby achieving improved heating capacity.

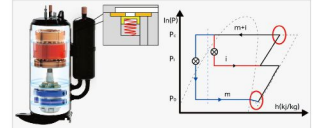

### High EER and COP(8/10/12HP)

The promotion of energy efficiency.

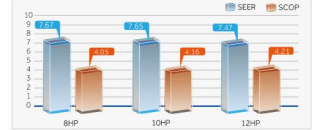

### DC fan and fan motor

- DC inverter fan motor more higher efficiency in part load running
- 16-stage speed control; high efficiency running especially in low speed
- Efficiency increase 45% comparing with AC motor and power input largely decrease
- Big diameter fan
- 570mm big diameter fan, more big air flow and more higher efficiency(8/10/12HP)

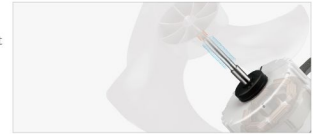

### Upgraded configuration, upgraded performance (8/10/12HP Side Discharge)

Bigger Outdoor Capacity, More Flexible Application

#### High efficiency DC fan motor

- DC fan motor with stepless inverter control, efficiency increase 45% comparing with AC motor and power input largely decrease

#### Large diameter fan

- Φ570mm big diameter axial flow fan
- 2-stage design, reduce air flow disturbance, air volume is bigger, the noise is lower

#### High efficiency condenser

- New type high efficiency ST inverter grooved tube
- Low hydrophilic corrugated fin, high efficiency



#### Vector inverter control

- 180 degree sine wave vector control, 64-bit operation
- High precision control, to achieve high efficiency and lower noise

#### Double pressure sensor

- Equipped with high and low voltage pressure double sensors
- Accurate pressure control, the system run more smoothly, more energy efficiency.

#### Twin rotary DC inverter compressor

- High chamber DC INVERTER twin rotary compressor
- Small vibration, low noise, high energy efficiency

### Indoor units and outdoor units self-cleaning

Indoor units and outdoor units cleaning mode conversion with nonstop, make abundant use of ODU waste heat to IDU defrosting, at the same time, the IDU uses the waste heat of the ODU to defrost the heat exchanger, to dry the condensed water, effectively prevent mold breeding.

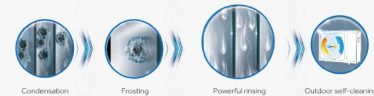

## HIGH EFFICIENCY

### High energy efficiency

#### DC inverter compressor

AQUA takes DC INV. compressor, 5% power input lower. (14kW)

#### DC fan motor and 550mm big fan

38% power input lower and 8% airflow higher

#### Larger heat exchanger

Heat exchange area rise 10%

### Low noise level

Night quiet operation function

Noise can be reduced to 45dB(A).

#### Charge Valve

Built-in charge valve enables safer and easier maintenance

#### Low standby power

New PCB programme, reduce 20% standby power consumption

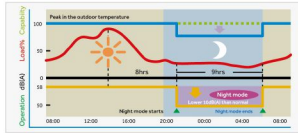

### New DC inverter twin rotary compressor

•Small torque change, good dynamic balance, the system runs stably, little vibration, low noise, high efficiency.

•More higher efficiency in part load running.

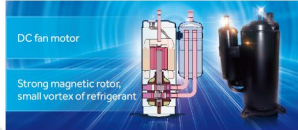

## SUPER COMFORT

1 New aerodynamics fan 550mm super big diameter aerospace helix fan, lowering sound level 3dB(A).

2 Enlarged air inlet path and spiral air outlet path Air flow direction follows the grill direction, lowering sound level 2-4 dB(A).

3 Automatic sound-lowering programme night mode set by PCB, 8dB(A) lower.

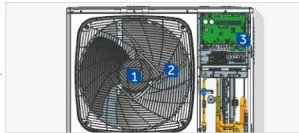

### Low noise operation

•DC INVERTER compressor, smooth operation, no need frequent start the compressor, effectively reduce the noise outdoor.

•Vector inverter control, more precise control.

•DC fan motor, motor bracket used the non-resonance structure, ensure smooth running of the motor, reduce operating noise.

•Big diameter fan, design according to aviation quieter principle.



### Easy installation

Compact side discharge design, Big capacity, Small footprint / Small footprint, only 0.42m<sup>2</sup>, 43% floor area can be reduced.



## EASY INSTALLATION

### 1 Double side "4" handles

Easy to carry

### 2 "888" test panel

All running data & error code can be checked from "888" screen, which is easy for installers

### 3 "Four-way" pipe connection

4-way (front, back, left & right) pipe connection, easy to design and install



### Compact side discharge design

No need additional ventilation hood comparing with top discharge unit.



### Long pipe length, high height drop

•Total pipe length: 300m.

•Single pipe length: Max. 175m.

•From outdoor to the first branch pipe: 135m.

•From the first branch to the farthest indoor door unit: 40m.

•Height drop: 50m (outdoor above)/40m (outdoor below).

•Height drop between indoor units: 15m.



### Separate refrigerant charging valve

Easy for refrigerant charging.

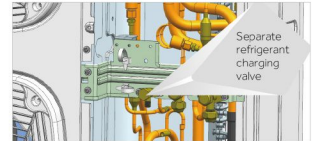

### Parameter display panel

The first original parameter display panel on the side, the parameter can be observed directly by opening the protective cover in case of maintenance, to avoid removing the repair board.



### Easy maintenance for control

The control box is in front, reserving space 108mm between control box and top panel, easy maintenance from the top control box is with hinge design, easy to open for maintenance(8/10/12HP).



## HIGH RELIABILITY

### Refrigerant automatically reclaim technology

Set refrigerant automatically reclaim through dip switch, the refrigerant in indoor and pipe can be automatically return to outdoor, convenient in maintenance and reducing waste of refrigerant, reduce customer maintenance cost, improve the efficiency of after-sales maintenance.

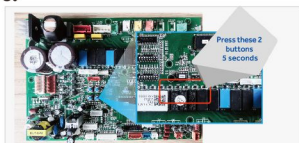

### Refrigerant control technology

Refrigerant control technology without high pressure accumulator, reducing the refrigerant volume and enhancing the running efficiency.

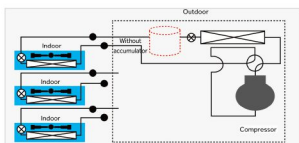

### Air inlet grill design on right side panel

Air inlet grill design, reducing the module temperature and avoid air dust into air conditioner.



### High and low double pressure sensor

- Double pressure sensor with PID control technology.
- Together with high speed communication to realize the quick start of compressor and more precise control, the temperature can be control  $\pm 0.5^{\circ}\text{C}$ .



AU042FNERS  
AU052FNERS

Model		AU042FNERS	AU052FNERS
Capacity <sup>(1)</sup>	Capacity range	HP	4 5
	Cooling	kW	12.1 14
	Heating	kW	12.1 14
	Heating(Max)	kW	14 15.5
	EER	/	2.85 2.8
	SEER	/	4.9 4.85
	$\eta$ %	%	195 191
	COP	/	2.95 2.9
	SCOP(T1)	/	3.5 3.55
	$\eta$ %	%	137 139
Electrical parameters	Power supply	PhV/V/Hz	1/220-240/50/60 1/220-240/50/60
	Rated Power input (Cooling)	kW	4.25 5.00
	Rated Power input (Heating)	kW	4.10 4.85
Dimensions	External (W/D/H)	mm	950/370/965 950/370/965
	Shipping (W/D/H)	mm	1010/458/990 1010/458/990
Weight	Net/Shipping weight	kg	90/102 90/102
	Compressor type	/	Rotary Rotary
Compressor	Motor Power	W	4130 4130
	Compressor quantity	/	1 1
Fan	Air flow (h)	m <sup>3</sup> /h	5400 5400
	Cooling	dB(A)	58 60
Pressure sound level	Heating	dB(A)	60 62
	Type	/	R410A R410A
Refrigerant	Charge	kg	3.3 3.3
	Refrigerant liquid pipe	mm	9.52 9.52
	Refrigerant gas pipe	mm	15.88 15.88
	Total pipe length	m	120 120
Piping	Max. pipe length(Equivalent/Actual)	m	70/60 70/60
	Max drop between L.U.&O.U.(ODU above / below)	m	30/20 30/20
	Max drop between L.U.&U.	m	10 10
	Connectable indoor unit ratio	%	50-130 50-130
Connection ratio	Maximum number of indoor units	/	7 8
	Working temp.	Cooling	$^{\circ}\text{C}$
Heating		$^{\circ}\text{C}$	-15-21 -15-21

(1) All the specifications are tested under nominal condition as per Eurovent conditions (In cooling, indoor temp is 27°C DB/19°C WB; Outdoor temp 35°C DB/24°C WB; In heating, indoor temp is 20°C DB; Outdoor temp is 7°C DB/6°C WB)

# MRV S II



Double fan series



Two stage sub-cooling



Total pipe length 300m



Easy connection with 4 way



Model		AU042FPERS	AU052FPERS	AU062FPERS	AU041FPERS	AU051FPERS	AU061FPERS	
Capacity (1)	Capacity range	HP	4	5	6	4	5	6
	Cooling	kW	12.1	14	15.5	12.1	14	15.5
	Heating	kW	14.2	16	18	14.2	16	18
	Heating(Max)	kW	/	/	/	/	/	/
	EER	/	4.05	3.99	3.6	4.05	3.99	3.6
	SEER	/	6.82	6.63	6.45	6.82	6.63	6.45
	ηs	%	269.8	262.2	255	269.8	262.2	255
	COP	/	4.47	4.3	4.1	4.47	4.3	4.1
Electrical parameters	SCOPT(1)	/	3.92	3.85	3.8	3.92	3.85	3.8
	ηs	%	153.8	151	149	153.8	151	149
	Power supply	PtV-V/Hz	1/220-240/50/60	1/220-240/50/60	1/220-240/50/60	3/380-415/50/60	3/380-415/50/60	3/380-415/50/60
	Rated Power input (Cooling)	kW	2.99	3.51	4.31	2.99	3.51	4.31
Dimensions	Rated Power input (Heating)	kW	3.18	3.72	4.39	3.18	3.72	4.39
	External (W/D/H)	mm	950/370/1350	950/370/1350	950/370/1350	950/370/1350	950/370/1350	950/370/1350
Weight	Shipping (W/D/H)	mm	1023/483/1492	1023/483/1492	1023/483/1492	1023/483/1492	1023/483/1492	1023/483/1492
	Net/Shipping weight	kg	108/123	108/123	108/123	108/123	108/123	108/123
Compressor	Compressor type	/	Rotary	Rotary	Rotary	Rotary	Rotary	Rotary
	Motor Power	W	4130	4130	4130	4060	4060	4060
	Compressor quantity	/	1	1	1	1	1	1
Fan	Air flow (H)	m³/h	7200	7200	7200	7200	7200	7200
	Cooling	dB(A)	57	58	59	57	58	59
Pressure sound level	Heating	dB(A)	57	58	59	57	58	59
	Refrigerant	Type	/	R410A	R410A	R410A	R410A	R410A
Piping	Charge	kg	4	4	4	4	4	4
	Refrigerant liquid pipe	mm	9.52	9.52	9.52	9.52	9.52	9.52
	Refrigerant gas pipe	mm	15.88	15.88	15.88	15.88	15.88	15.88
	Total pipe length	m	300	300	300	300	300	300
	Max. pipe length(Equivalent/Actual)	m	175/150	175/150	175/150	175/150	175/150	175/150
	Max drop between LU & O.U.(O.D.U. above / below)	m	50/40	50/40	50/40	50/40	50/40	50/40
Connection ratio	Max drop between LU & U.	m	15	15	15	15	15	15
	Connectable indoor unit ratio	%	50-130	50-130	50-130	50-130	50-130	50-130
	Maximum number of indoor units	/	8	10	15	8	10	15
	Working temp.	Cooling	°C	-5-50	-5-50	-5-50	-5-50	-5-50
Heating		°C	-20-27	-20-27	-20-27	-20-27	-20-27	-20-27

(1) All the specifications are tested under nominal condition as per Eurovent conditions (In cooling, Indoor temp: 27°C DB/19°C WB, Outdoor temp: 35°C DB/24°C WB; in heating, Indoor temp is 20°C DB, Outdoor temp is 7°C DB/9°C WB)



- AU042FPERS
- AU052FPERS
- AU062FPERS
- AU041FPERS
- AU051FPERS
- AU061FPERS



- AU08NFKERS
- AU10NFKERS
- AU12NFKERS



# Dimensions

AU042FNERA AU052FNERA

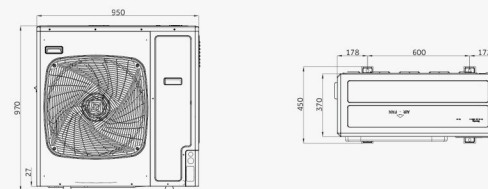

AU042FPERA AU052FPERA AU062FPERA AU04IFPERA AU05IFPERA AU06IFPERA

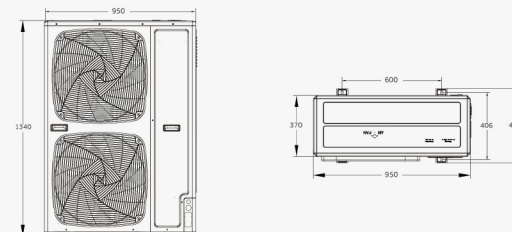

AU08NFKERA AU10NFKERA AU12NFKERA

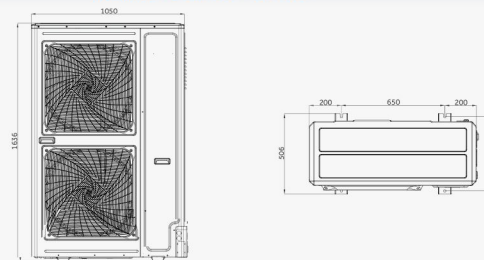

Model		AU08NFKERS	AU10NFKERS	AU12NFKERS	
Capacity (1)	Capacity range	HP	8HP	10HP	12HP
	Cooling	kW	22.6	28	33.5
	Heating	kW	25	31.5	37.5
	Heating(Max)	kW	/	/	/
	EER	/	3.9	3.5	3.44
	SEER	/	/	/	/
	ηs	%	/	/	/
	COP	/	4.6	4.2	3.9
	SCOP(T1)	/	/	/	/
	ηs	%	/	/	/
Electrical parameters	Power supply	Ph/V/Hz	3/380-415/50/60	3/380-415/50/60	3/380-415/50/60
	Rated Power input (Cooling)	kW	5.79	8.00	9.74
	Rated Power input (Heating)	kW	5.43	7.50	9.62
Dimensions	External (W/D/H)	mm	1050/400/1636	1050/400/1636	1050/400/1636
	Shipping (W/D/H)	mm	1150/510/1790	1150/510/1790	1150/510/1790
Weight	Net/Shipping weight	kg	149/168	149/168	149/168
	Compressor type	/	Inverter Twin Rotary	Inverter Twin Rotary	Inverter Twin Rotary
Compressor	Motor Power	W	6270	6270	6270
	Compressor quantity	/	1	1	1
	Fan	Air flow (l/h)	m <sup>3</sup> /h	10000	10000
Pressure sound level	Cooling	dB(A)	63	64	65
	Heating	dB(A)	65	66	67
Refrigerant	Type	/	R410A	R410A	R410A
	Charge	kg	5.1	5.1	5.1
Piping	Refrigerant liquid pipe	mm	9.52	9.52	12.7
	Refrigerant gas pipe	mm	19.05	22.22	25.4
	Total pipe length	m	300	300	300
	Max. pipe length (Equivalent/Actual)	m	175/150	175/150	175/150
	Max drop between I.U. & O.U. (COU above / below)	m	50/40	50/40	50/40
Connection ratio	Max drop between I.U. & I.U.	m	15	15	15
	Connectable indoor unit ratio	%	50-130	50-130	50-130
	Maximum number of indoor units	/	13	16	19
Working temp.	Cooling	°C	-5-48	-5-48	-5-48
	Heating	°C	-20-27	-20-27	-20-27

(1) All the specifications are tested under normal condition as per Eurovent conditions (In cooling, Indoor temp is 27°C DB/19°C WB, Outdoor temp 35°C DB/24°C WB. In heating, Indoor temp is 20°C DB, Outdoor temp is 7°C DB/6°C WB)

# EASY MRV Connection Kit

**091** Features & Benefits

**094** Specification

**094** Dimensions



# EASY MRV Connection Kit



## SYSTEM INTRODUCTION

Intergrated system solution  
Connect MRV with super match together.



## SYSTEM INTRODUCTION

### Easy MRV system introduction

AQUA Easy MRV kit provides a solution to connect Super Match indoor units with MRV outdoor units.

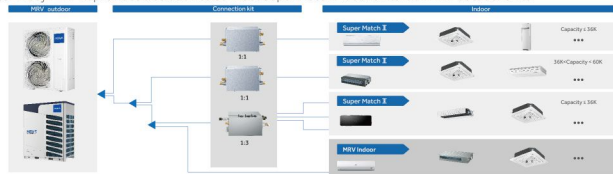

### Easy MRV line-up

Easy MRV kits provide a solution to connect super match indoor units with MRV outdoor units.

OUTDOOR	MRV5	MRV IV	MRV III-C <sup>Plus</sup> MRV III(2-Pipe)	MRV S <sup>1</sup>			MRV S <sup>2</sup>							
HP	8-26	8-24	8-16	4	5	4	5	6	8	10	12	3	5	7
Power supply	3P/N/380-415V/50/60Hz 3P/N/208-230V/50/60Hz	3P/N/380-400V/50/60Hz 3P/N/208-230V/50/60Hz	3P/N/380-400V/50/60Hz 3P/N/208-230V/50/60Hz	3P/N/220-240V/50/60Hz	3P/N/220-240V/50/60Hz	3P/N/380-415V/50/60Hz 3P/N/220-240V/50/60Hz	3P/N/380-400V/50/60Hz 3P/N/220-230V/50/60Hz	3P/N/380-400V/50/60Hz 3P/N/220-230V/50/60Hz	3P/N/380-400V/50/60Hz 3P/N/220-230V/50/60Hz	3P/N/380-400V/50/60Hz 3P/N/220-230V/50/60Hz	3P/N/380-400V/50/60Hz 3P/N/220-230V/50/60Hz	3P/N/380-400V/50/60Hz 3P/N/220-230V/50/60Hz	3P/N/380-400V/50/60Hz 3P/N/220-230V/50/60Hz	3P/N/380-400V/50/60Hz 3P/N/220-230V/50/60Hz
				Valve Box										
				MS1-036A(L)11			MS1-060A(L)11			MS1-036A(L)11				

### Easy MRV super match indoor

Easy MRV indoor is universal indoor unit with super match.

RAC Indoor unit					
Flexis	Expert	Jade	Pearl	IES	
AS202SF-F/A-HB AS202SF-F/A-MW AS202SF-F/A-MN AS202SF-F/A-NW AS202SF-F/A-HB AS202SF-F/A-MW AS202SF-F/A-NW	AS202SF-F/A-HB AS202SF-F/A-MW AS202SF-F/A-MN AS202SF-F/A-NW AS202SF-F/A-HB AS202SF-F/A-MW AS202SF-F/A-NW	AS20CAHRA AS20CAHRA AS20CAHRA AS20CAHRA	AS202S1F/A-1 AS202S1F/A-1 AS202S1F/A-1 AS202S1F/A-1	AS20PWA AS20PWA AS20PWA AS20PWA AS20PWA AS20PWA AS20PWA	AS202S2F/A-1 AS202S2F/A-1 AS202S2F/A-1 AS202S2F/A-1 AS202S2F/A-1 AS202S2F/A-1 AS202S2F/A-1
Super Match Indoor unit					
Compact Cassette	Round way Cassette	Slim Duct	M ESP Duct	HESP Duct	
AB252C2F/A-1 AB252C2F/A-1 AB252C2F/A-1	AB712S2G1FA ABH403H1ERG ABH403H21ERG ABH449K1ERG ABH449K21ERG ABH449K31ERG	AD212S51FAH AD312S51FAH AD512S51FAH AD712S51FAH	AD302S2M1FAH AD712S2M1FAH AD302S2M2FAH AD112S2M1FAH AD312S2M1FAH AD302S2M3FAH	ADH12H1ERG ADH18H1ERG	
Console	Convertible	CABINET			
AF252S21FAH AF252S21FAH AF252S21FAH	AC325S21FA AC1402S2K1FA AC300S21FA AC112S2G1FA AC305S21FA AC325S21FA	AP48K1ERMS AP60K1ERMS AP1402S1FAH			





# MRV AHU Connection Kit

**097** The 2nd Generation AHU Kit

**100** Specification

**100** Dimensions



# MRV AHU

The 2<sup>nd</sup> Generation AHU Kit



## SYSTEM INTRODUCTION

### System introduction.

AQUA offers a range of connection kit to connect MRV outdoor units to third party DX air handling units.

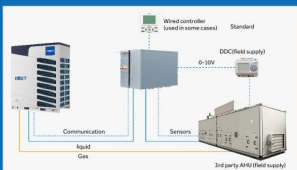

## SYSTEM INTRODUCTION

### AHU kit configuration

AQUA 2nd generation AHU kit also contains the following 4 parts: the controller model is HW-AA 101 DBK, special for AQUA 2nd generation AHU kit as standard accessory, no need to be purchased separately.

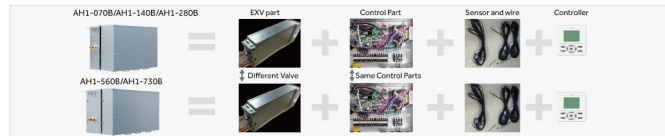

### System line-up

AQUA AHU kit provides a wide range solution for AQUA MRV outdoor unit connecting with the 3rd party AHU.

DX AHU Connection kit						Special design for MRV S1, MRV S9			
Model	AH1-070B	AH1-140B	AH1-280B	AH1-560B	AH1-730B				
Capacity	1-10 Connected AHU capacity 10kW	1-2 Connected AHU capacity 10kW	1-4 Connected AHU capacity 20kW	1-8 Connected AHU capacity 20kW	1-8 Connected AHU capacity 10kW				
<b>Compatibility</b>									
Outdoor	MRV S1			MRV S9					
HP	8-25			4	5	6	8	10	12
Power supply	3PhV380-415V/50/60Hz			3PhV220-230V/50/60Hz		3PhV380-400V/50/60Hz		3PhV380-400V/50/60Hz	
AHU & MRV indoor	AHU need purchase in Market								

### Control solutions

Four control methods can be used, which can be switched by dip switch based on the site scenario.

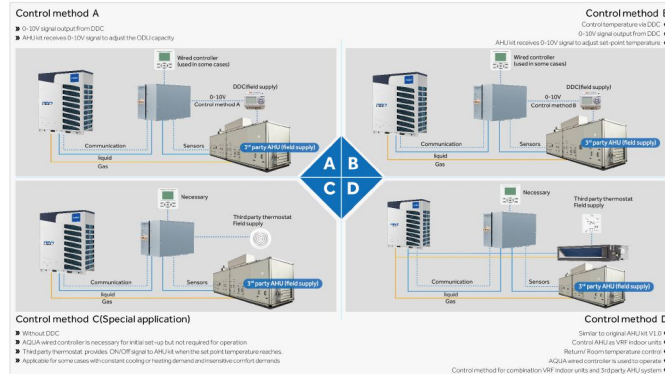

# SYSTEM INTRODUCTION

## Central control

Note:

- MRV 5 and upgraded MRV SII(8/10/12HP) can directly connect with central controller HC-SA164DBT and YCZ-A004.
- Other MRV systems need the HA-MA164AD gateway.
- For new webserver controller, the new gateway HA-MA1ADB.
- For control method A.B.C of AHU kit, only monitoring the AHU is available and unable to conduct control operation.
- For control solution D of AHU kit, AHU can be controlled as one MRV indoor unit, both monitoring and control operations are available.

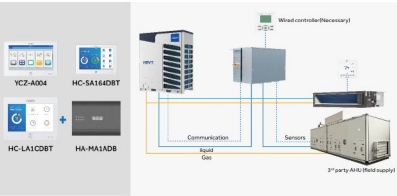

## Bms control

Note:

- Integrate AQUA remote monitoring and controlling system via PC and BMS interface
- HCM-01A: Modbus rtu
- HCM-01SA: Modbus ip/ Bacnet ip
- HCM-05: Bacnet ip

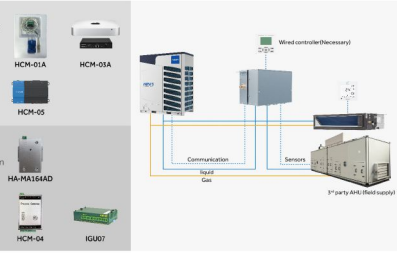

Note:

- Only have BMS interface without AQUA remote monitoring system
- HA-MA164AD: Modbus for MRV 5 and upgraded MRV SII (8/10/12HP) integrates this function
- HCM-04: Bacnet
- IGU07: Lonworks



# UNIT STRUCTURE

## Features

- Extend the AHU connected capacity of per kit ranging from 3.5 kW to 73kW, which can meet the small, medium and large buildings demands.
- Add the 0-10V signal control.
- Supply air temperature (from DDC) or return air temperature controllable.
- Remove the gas pipe, more convenient for installation.

### The 2<sup>nd</sup> generation AHU kit VS The 1<sup>st</sup> generation AHU kit

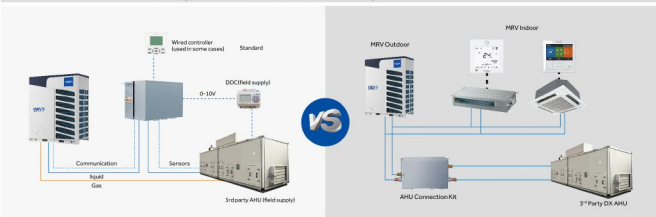

# SPECIFICATION

Model	AH1-070B	AH1-140B	AH1-280B	AH1-560B	AH1-730B
Connected	3.5xS7KW	7<Xs14KW	14<Xs28KW	28<Xs56KW	56<Xs73KW
AHU capacity	(1-5HP)	(3-5HP)	(5-10HP)	(10-20HP)	(20-26HP)
Power Supply (Ph/V/Hz)	1/220-240/50/60	1/220-240/50/60	1/220-240/50/60	1/220-240/50/60	1/220-240/50/60
Dimension (W/D/H) (mm)	420/260/165	420/260/165	420/260/165	420/260/215	420/260/215
Shipping dimensions (mm)	520/340/225	520/340/225	520/340/225	520/340/275	520/340/275
Material	Galvanized steel	Galvanized steel	Galvanized steel	Galvanized steel	Galvanized steel
Color	Grey	Grey	Grey	Grey	Grey
Weight (KG)	5.5	5.5	5.5	6.5	6.5
Shipping Weight (KG)	8.5	8.5	8.5	10	10
Liquid pipe (mm)	9.52 (Main) / 6.35	9.52 (Main) / 6.35	9.52 (Main) / 6.35	12.7 (Main) / 15.88	12.7 (Main) / 15.88
AHU Kit-3rd party AHU Max Single pipe length (m)	5	5	5	5	5
AHU Kit-3rd party AHU Max Single pipe length (m)	5	5	5	5	5

AH1-070B AH1-140B AH1-280B

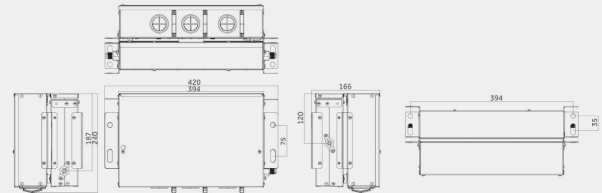

AH1-560B AH1-730B

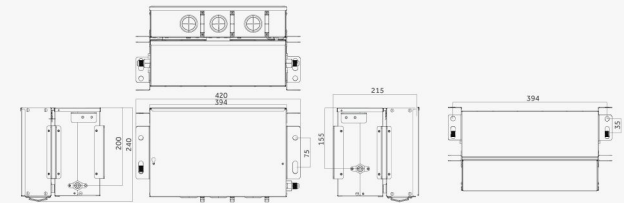



# MRV INDOOR (Air Guard)

- 103** Air Guard Features
- 105** Slim Duct(0/15/30Pa)
- 107** High ESP Duct (20/200Pa)

# MRV INDOOR (Air Guard)

## HEALTHY

### UVC sterilization

The built-in LED UV lights kill airborne hazards when the air circulates from air inlet, ensuring the clean air out.



### Antibacterial filter

Silver (Ag) is a natural antibacterial material, which has good broad-spectrum antibacterial properties and could motivate bacterial extinction.

AQUA antibacterial filter has added silver ions and antibacterial organics to kill Escherichia coli & Staphylococcus aureus effectively, with long lasting effects.



## HEALTHY

### Blowing healthier air

Mold and bacteria are no longer able to grow on the components where air flows through, and silver ions bring no harm to human body, thus, the air comes out of the air conditioner is always healthy.

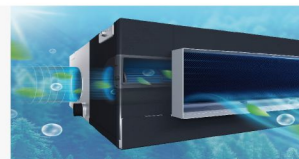

### Self-cleaning

Make the ODU and IDU cleaning mode conversion without stopping, make full use of the waste heat of the ODU to defrost the IDU with faster speed. Which means when the ODU fins frost to strip the dirt while IDU will defrost and dry the evaporator by using the waste heat of ODU.



## EASY INSTALLATION

### Multi dimensions

Two series duct you can choose, Slim duct & High ESP duct, the height are 185mm and 248mm, suitable for different situations.

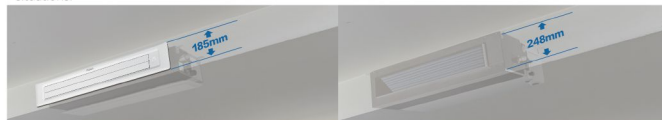

### Multi ESP

Two ESP design you can choose, the ESP of Slim duct is 0/15/30 Pa, the ESP of High ESP is 20-200Pa, suitable for different duct pipe length.



### This series of duct can be arranged in two air return modes

•Air return from the back (Factory default) •Air return from the bottom (Can be adjusted on site).

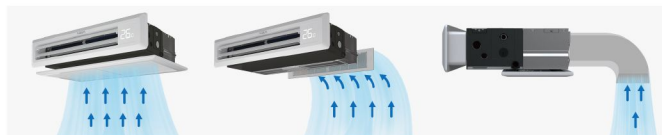

# Slim DUCT



Reserved fresh air inlet



Friendly design of rear or bottom air return



Super slim design, only 18.5mm



Built-in high head drain pump

# (0/15/30Pa)



YR-E17A



HW-BA101ABT



YR-E16B



YR-HRS01

## Slim DUCT (0/15/30Pa)

Model/Indoor unit		AD02MSERA(H)	AD07MSERA(H)	AD092MSERA(H)	AD122MSERA(H)	AD162MSERA(H)	AD182MSERA(H)	AD242MSERA(H)
Capacity	Cooling	kBtu/h	5.1	7.5	9.5	12.3	15.3	24.2
		kW	1.5	2.2	2.8	3.6	4.5	5.6
	Heating	kBtu/h	5.8	8.5	10.9	13.6	17.1	21.5
		kW	1.7	2.5	3.2	4	5	6.3
Electrical Parameters	Power supply	Ph/V/Hz	1/220-230/50/60	1/220-230/50/60	1/220-230/50/60	1/220-230/50/60	1/220-230/50/60	1/220-230/50/60
	Air flow (m³/h)	m³/h	430/370/310	480/420/360	480/420/360	550/430/370	600/440/460	800/690/580
Performance	Sound pressure level(H/M/L)	dB(A)	26/22/19	27/23/20	27/23/20	30/27/24	32/29/26	33/30/27
	Sound power level(H/M/L)	dB(A)	40/35/33	41/37/34	41/37/34	44/41/38	46/43/40	47/44/41
	External dimensions(WD/H)	mm	850/420/185	850/420/185	850/420/185	850/420/185	850/420/185	1170/420/185
	Shipping dimensions(WD/H)	mm	1045/540/270	1045/540/270	1045/540/270	1045/540/270	1045/540/270	1365/540/270
Installation	Net/Shipping weight	kg	16.5/21.5	17.5/22.5	17.5/22.5	17.5/22.5	18.5/23.5	22.2/28.2
	Refrigerant liquid pipe	mm	6.35	6.35	6.35	6.35	6.35	6.35
	Refrigerant gas pipe	mm	9.52	9.52	9.52	12.7	12.7	12.7
	Static Pressure(Standard/Max.)	Pa	0/15/30	0/15/30	0/15/30	0/15/30	0/15/30	0/15/30
	Panel model	/	P1B-890A/D	P1B-890A/D	P1B-890A/D	P1B-890A/D	P1B-890A/D	P1B-1210A/D
Panel	External dimensions(WD/H)	mm	890/190/100 (outlet panel)	890/190/100 (outlet panel)	890/190/100 (outlet panel)	890/190/100 (outlet panel)	890/190/100 (outlet panel)	1210/190/100 (outlet panel)
	External dimensions(WD/H)	mm	890/290/5/32.4 (inlet panel)	890/290/5/32.4 (inlet panel)	890/290/5/32.4 (inlet panel)	890/290/5/32.4 (inlet panel)	890/290/5/32.4 (inlet panel)	1210/290/5/32.4 (inlet panel)
	Shipping dimensions(WD/H)	mm	938/335/220	938/335/220	938/335/220	938/335/220	938/335/220	1258/335/220
	Net/Shipping weight	kg	4/5	4/5	4/5	4/5	4/5	5/6
Drain pump	O-optional/S-standard/W-without	/	S	S	S	S	S	S
		/	HW-BA101ABT	HW-BA101ABT	HW-BA101ABT	HW-BA101ABT	HW-BA101ABT	HW-BA101ABT
Controller	Wired(Optional)	/	YR-E17A	YR-E17A	YR-E17A	YR-E17A	YR-E17A	YR-E17A
		/	YR-E16B	YR-E16B	YR-E16B	YR-E16B	YR-E16B	YR-E16B
	Infrared (Optional)	/	YR-HRS01	YR-HRS01	YR-HRS01	YR-HRS01	YR-HRS01	YR-HRS01



# High ESP DUCT

20/200Pa

20/200Pa



Built-in drain pump



Only 24mm thick

50/60Hz

All module can realize 50/60Hz

# (20/200Pa)



HW-BA116ABK

YR-E17A

HW-BA101ABT

YR-E16B

YR-HRS01

High ESP  
**DUCT** (20/200Pa)

Model/Indoor unit		AD052MJERAH	AD072MJERAH	AD092MJERAH		AD122MJERAH	AD162MJERAH	AD182MJERAH	AD242MJERAH	AD282MJERAH	AD302MJERAH	AD382MJERAH	AD482MJERAH	AD542MJERAH
Capacity	Cooling	kBtu/h	5.1	7.5	9.6	12.3	15.3	19.1	24.2	27.3	30.7	38.2	47.8	54.6
		kW	1.5	2.2	2.8	3.6	4.5	5.6	7.1	8	9	11.2	14	16
	Heating	kBtu/h	5.8	8.5	10.9	13.7	17	21.5	27.3	30.7	34.1	44.4	55.6	61.4
		kW	1.7	2.5	3.2	4	5	6.3	8	9	10	13	16.3	18
Electrical Parameters	Power supply	Ph/V/Hz	1/220-240/50/60	1/220-240/50/60	1/220-240/50/60	1/220-240/50/60	1/220-240/50/60	1/220-240/50/60	1/220-240/50/60	1/220-240/50/60	1/220-240/50/60	1/220-240/50/60	1/220-240/50/60	1/220-240/50/60
Dimensions (W/D/H)	Net Product	mm	700/700/248	700/700/248	700/700/248	700/700/248	700/700/248	1100/700/248	1100/700/248	1100/700/248	1500/700/248	1500/700/248	1500/700/248	1500/700/248
	Shipping Product	mm	932/835/280	932/835/280	932/835/280	932/835/280	932/835/280	1332/835/280	1332/835/280	1332/835/280	1698/857/305	1698/857/305	1698/857/305	1698/857/305
Weight	Product Net/Shipping	kg	27/32	27/32	27/32	27/32	28.5/33.5	36.8/43.4	36.8/43.4	36.8/43.4	59.4/43.4	59.4/43.4	51.3/59.5	51.3/59.5
	Static Pressure(Standard/Max)	Pa	20/200	20/200	20/200	20/200	20/200	20/200	20/200	20/200	20/180	20/180	20/180	20/180
Fan	Air flow (M/M/L)	m <sup>3</sup> /h	515/440/590	545/470/590	545/470/590	570/495/420	700/625/530	915/765/640	1275/1050/875	1275/1050/875	1450/1200/1000	2000/1700/1400	2150/1750/1400	2350/1950/1600
	Sound level	dB(A)	29/27/25	30/28/25	30/28/25	31/29/27	32/30/28	33/31/29	34/31/29	35/33/30	36/33/30	38/35/32	40/36/32	42/38/34
Piping	Refrigerant liquid pipe	mm	41/39/37	42/40/37	42/40/37	43/41/39	44/42/40	45/43/41	46/43/41	47/45/42	48/45/42	50/47/44	52/48/44	54/50/46
	Refrigerant gas pipe	mm	6.35	6.35	6.35	6.35	6.35	9.52	9.52	9.52	9.52	9.52	9.52	9.52
Drain pump	O-optional S-standard W-without	/	S	S	S	S	S	S	S	S	S	S	S	S
	Wire/Optional	/	YR-E17A	YR-E17A	YR-E17A	YR-E17A	YR-E17A	YR-E17A	YR-E17A	YR-E17A	YR-E17A	YR-E17A	YR-E17A	YR-E17A
Controller	/	YR-E16B	YR-E16B	YR-E16B	YR-E16B	YR-E16B	YR-E16B	YR-E16B	YR-E16B	YR-E16B	YR-E16B	YR-E16B	YR-E16B	YR-E16B
		HW-BA116ABK	HW-BA116ABK	HW-BA116ABK	HW-BA116ABK	HW-BA116ABK	HW-BA116ABK	HW-BA116ABK	HW-BA116ABK	HW-BA116ABK	HW-BA116ABK	HW-BA116ABK	HW-BA116ABK	HW-BA116ABK
	HW-BA101ABT	HW-BA101ABT	HW-BA101ABT	HW-BA101ABT	HW-BA101ABT	HW-BA101ABT	HW-BA101ABT	HW-BA101ABT	HW-BA101ABT	HW-BA101ABT	HW-BA101ABT	HW-BA101ABT	HW-BA101ABT	
	Infrared/Optional	/	YR-HRS01	YR-HRS01	YR-HRS01	YR-HRS01	YR-HRS01	YR-HRS01	YR-HRS01	YR-HRS01	YR-HRS01	YR-HRS01	YR-HRS01	YR-HRS01

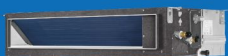



# MRV INDOOR

- 111 Features
- 125 1-Way Cassette
- 129 2-Way Cassette
- 133 Compact Cassette
- 135 Round Way Cassette
- 137 4-Way Cassette
- 141 Convertible Type
- 143 Slim Duct
- 147 Medium ESP Duct (50/100Pa)
- 149 High ESP Duct (20/200Pa)
- 151 Compact Air Duct (50/120Pa)
- 153 High ESP Duct (100/250Pa)
- 155 High ESP Duct (0/300Pa)
- 157 Built-in Floor Standing
- 159 Console
- 161 High Wall
- 171 Dimensions



## 1-Way Cassette

## 2-Way Cassette

Add new appearance series, DC fan motor, the capacity is from 1.5kw to 7.1kw, give you more flexi choice.

High ceiling design the air reaches the ground

New DC series

Provides you with DC large capacity models the capacity is from 2.2kw to 14kw, quieter experience and more flexible solutions. (coming soon)

Anti-fouling ceiling design

Unique antifouling and antifogging airflow design, no flocking guide plate, reduce dirt on the ceiling.

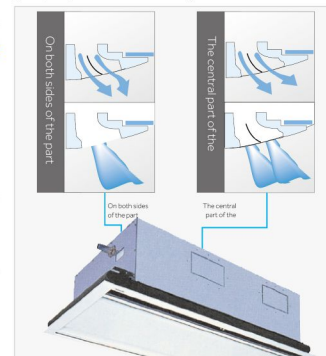

Standard condensate water lifting pump

Equipped with 700mm drain pump, built-in float switch, convenient according to the actual working situation, discharge condensate water from air conditioner.

Super wide angle air supply comfortable enjoy

Adopt new DC motor, equipped with up and down, left and right swing wind motor, realize intelligent swing wind control and ultra wide Angle air supply range, enjoy comfortable air.

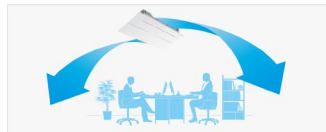
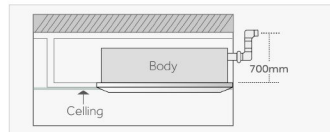

Thin and light design for easy installation

Height is only 220mm, reduce the limitations of installation space, light weight design to improve installation convenience.

The drain pump lift is 750mm

Adopt high lift and large volume discharge pump, the lift can up to 750mm ( from the ceiling).

Suitable for corner installation for comfortable and uniform air supply

Compact design, full use of corner space installation, such as small meeting rooms, corridorsetc.: the indoor machine is located in the ceiling, and the panel adopts the integrated design, which is generous and beautiful, suitable for long and narrow rooms, to ensure the uniform distribution of air flow and room temperature.

New butterfly wing air supply, 5 step fan speed is optional, enjoy healthy air

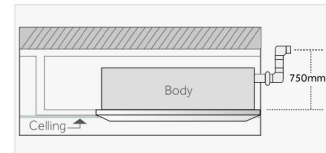
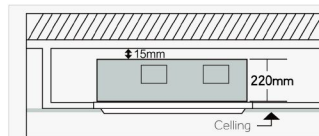
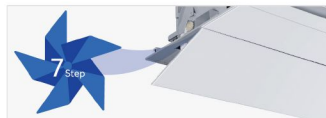



## Round Way Cassette

### Free air supply and flexible control to enjoy a comfortable environment

The outlet adopts stepper motor design to realize the four-direction independent control system.



### Quiet operation, create a peaceful space

•High efficiency brushless DC fan motor, achieve step-less adjustment for speed, greatly reduce the noise of operation.

•Optimize the traditional air duct design, adopt sound insulation wall technology, effectively reduce the eddy current range, block the transmission path of noise, effectively reduce the noise about 3dB(A).

•Fan optimization design, using the principle of fluid mechanics, referring to the design of aviation structure, so that the airflow speed distribution is uniform, reduce the airflow resistance, so as to reduce noise, to achieve quiet operation. Note: \* Other ac motor standards are optional.



### Standard drain pump

Standard drain pump, the lift is 700mm and built-in float switch, convenient to cooperate with the actual situation to condensate water discharge air conditioning.

### Antibacterial filter



### Streamlined outlook design

Buy a traditional grille and a dynamic windmill for multi-choice and multi-enjoyment. Buy a dynamic windmill to enjoy a dynamic mood and relax in the wind.



### Energy saving control

The product adopts MOVE EYE module (optional), which can be controlled to realize the function of switch-on when people coming in and switch-off when people leaving.



## 4-Way Cassette

### Square panel the whole product unified more beautiful

•Square design, makes room decoration more harmonious, beautiful and easy to arrange lighting system.  
•Thin design of indoor unit, the height is only 260mm (2HP), even in a small space can be installed.  
Stereo air supply, more comfortable.

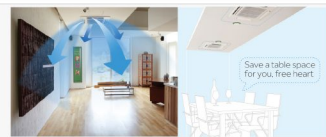
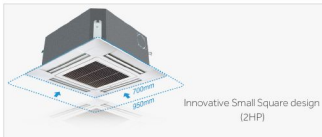

### Healthy fresh air function

Unique side air inlet, can open to introduce outdoor fresh air, improve indoor air quality.



### Quiet operation, comfortable experience

Adopt advanced aviation technology of THREE-DIMENSIONAL spiral fan and turbine shaped air duct design, greatly reduce the internal resistance, large air volume, low noise, achieve silent operation.

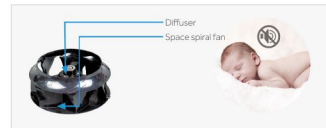

### Standard condensate lift pump

Standard drain pump, the lift is 700mm and built-in float switch, convenient to cooperate with the actual situation to condensate water discharge air conditioning.

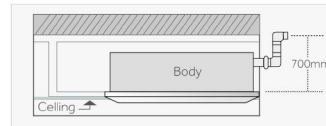



## Convertible Type

## Slim Duct

### Thinner body design, good value option

Thin fuselage thickness is only 199mm, streamlined design, beautiful and generous, commercial home decoration value choice.

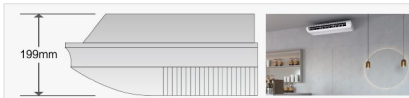

### Standard with filter, easy installation

With high efficiency filter, fully filter dust, smoke and other fine particles in the air, improve indoor air quality, filter net easy disassembly, easy cleaning, reduce cleaning and maintenance operations, so that you enjoy fresh air.

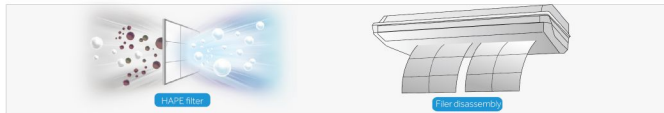

### Air supply in 5 angles, more comfortable

Double swing air motor design, while up and down swing air supply, left and right swing air can also adjust the angle of air supply, realize the full wind level three-dimensional air supply, at the same time provide four speed adjustable, improve user comfort.

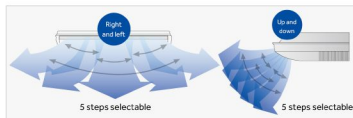

### Multiple installation modes flexible optional

Users can choose ceiling installation, also can choose ground installation, convenient for users to choose freely.

### Antibacterial filter

Silver (Ag) is a natural antibacterial material, which has good broad-spectrum antibacterial properties and could motivate bacterial extinction.

AQUA antibacterial filter has added silver ions and antibacterial organics to kill Escherichia coli & Staphylococcus aureus effectively, with long lasting effects.



### Adjusted ESP super slim save installation space agile and convenient

Fuselage thickness of only 180mm, easy to install in the height of narrow residential ceiling, fuselage depth of only 450mm, save the ceiling area, and fully cooperate with the interior decoration.

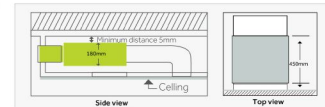

### Quiet operation

•High efficiency model \* High efficiency brushless DC motor, speed stepless adjustment, can achieve seven air supply, greatly reduce operating noise.

•Through the reasonable design of indoor unit thermal components and internal air duct, four block wind speed, silent operation is realized. Note: the standard model of AC motor is also available.

### High lift-up drain pump

Standard condensate water lifting pump, standard head 700mm, special models customized range up to 1200mm, and built-in float switch, convenient to cooperate with the actual situation of the site, condensate water discharge air conditioning.

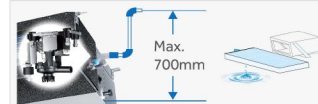

### Antibacterial filter



### Return air mode selection according to local conditions -- more user-friendly installation

Provide bottom and rear two return air modes, indoor installation more flexible and convenient, users can choose the best installation scheme according to the characteristics of interior decoration. Note: If there is enough installation space, it is recommended to use the side feed back mode, which can effectively reduce the running sound.

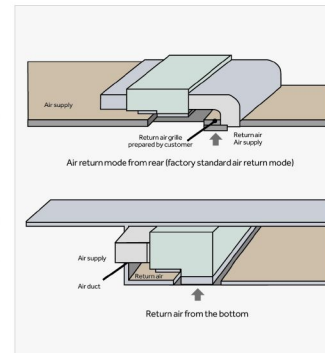



## Slim Duct

## Medium ESP Duct(50~100Pa)

### 3D Three-dimensional air supply

#### With makings fastidious

Air guide plate, shutter adopts PC+ABS, high temperature resistance, not easy to deformation, color and luster lasting.

#### Sympathetic function

The panel parameters are displayed in invisible mode, which makes it softer. the temperature display and color transformation of refrigeration and heating are green and red, which are more classy.

#### Details of the outstanding using at ease

The air inlet grille can be dismantled and cleaned by pulling the buckle, which is more convenient.

#### Fashionable and beautiful

Streamline design, automatic shutdown, no ash accumulation, beautiful atmosphere, hidden installation and home decoration perfect combination, highlight grade.

The horizontal louver is driven by two motors, which makes it easier to run.

Vertical louvers are driven by an electric motor and run freely.

#### 3D three-dimensional air supply

- Pendulum blade two motor control, vertical louver one motor control, easy to operate
- Free swing wind between 30-80 degrees up and down, swing wind around 90 degrees, 3D three-dimensional air supply, wide angle of air supply.

### Static pressure optional, meet different needs

According to users requirements, the static pressure can be adjusted by wire controller instead of the traditional way of changing the red and white terminals. The maximum static pressure of the whole series can reach 100Pa.

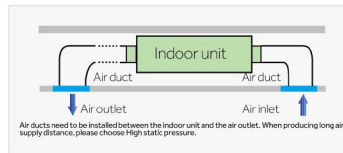

### Hidden design, more beautiful

Thin height design, the unit can be easily placed in the ceiling, only the air outlet exposed, can not feel the existence of indoor unit, so that the indoor space suddenly open.

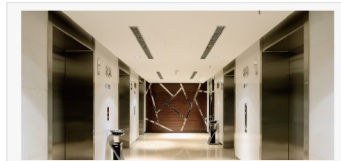

### Antibacterial filter

Silver (Ag) is a natural antibacterial material, which has good broad-spectrum antibacterial properties and could motivate bacterial extinction.

AQUA antibacterial filter has added silver ions and antibacterial organics to kill Escherichia coli & Staphylococcus aureus effectively, with long lasting effects.



### Free setting air outlet humanization setting

Due to the use of pipe air supply, according to the room environment and user requirements to freely choose the number of air outlet and installation position, fully consider the load of the room and room temperature balance, to achieve a more perfect and comfortable feeling.





## Compact Duct (50~120Pa)

### Compact design, suitable for hallway installation

The width of the compact duct is only 1100mm, and the height is only 248mm, so it can be well hidden installed in the ceiling of the hallway. The capacity can be 9kw/11.2kw/14kw, meet the needs of 50m<sup>2</sup>~100m<sup>2</sup> area room air conditioning.

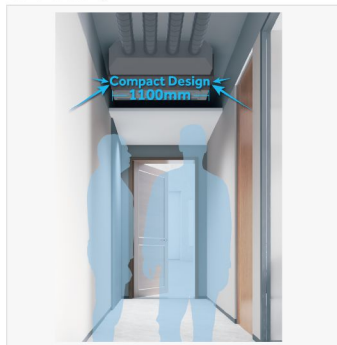

### Five steps pressure choice

The ESP can be selected in five steps with 0/20/50/80/120Pa to suit different ductwork length.



### Air zone control accessories (optional)

Zoning control systems for ducted AC units: energy savings and comfort, to control of a ducted unit with just a single thermostat.



### Antibacterial filter

Silver (Ag) is a natural antibacterial material, which has good broad-spectrum antibacterial properties and could motivate bacterial extinction.

AQUA antibacterial filter has added silver ions and antibacterial organics to kill Escherichia coli & Staphylococcus aureus effectively, with long lasting effects.



## High ESP Duct (20~200Pa)

### Static pressure optional, meet different needs

According to users requirements, the static pressure can be adjusted by wire controller instead of the traditional way of changing the red and white terminals. The maximum static pressure of the whole series can reach 200Pa for model AD05/07/09/12/16/18/24/28M.ERAD, 180Pa for model AD30/38/48/54M.ERAD

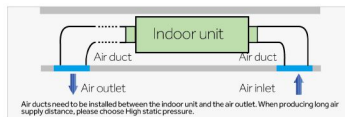

### Air duct connection more room to share

The unit can connect multiple rooms through air duct, and can be flexibly arranged according to different house types, one air conditioner, multi-room sharing.



### Hidden design, more beautiful

Thin height design, the unit can be easily placed in the ceiling, only the air outlet exposed, can not feel the existence of indoor unit, so that the indoor space suddenly open.



### Free setting air outlet humanization setting

Due to the use of pipe air supply, according to the room environment and user requirements to freely choose the number of air outlet and installation position, fully consider the load of the room and room temperature balance, to achieve a more perfect and comfortable feeling.



### High lift-up drain pump

Standard condensate water lifting pump, standard head 700mm, special models customized range up to 1200mm, and built-in float switch, convenient to cooperate with the actual situation of the site, condensate water discharge air conditioning.

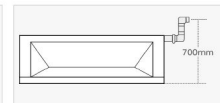



## High ESP Duct(100~250Pa)

## High ESP Duct (300Pa)

### High static pressure design, more room to share

The external static pressure can achieve 250Pa, and the air duct can be freely selected. Do an air conditioning, multi-room sharing.

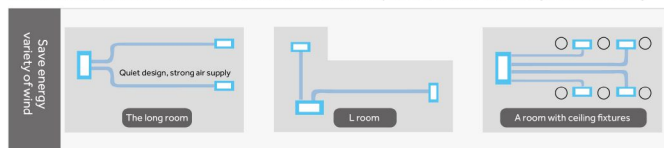

### Silence design

- Adopt international new sound insulation noise reduction materials, pressure off mute wind wheel.
- Prevents indoor pollution and provides maximum wind speed, ensuring air circulation throughout the room.
- 5 speed adjustable wind speed to meet different needs.

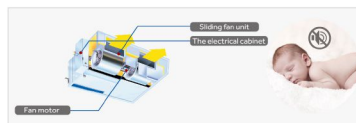

### Multiple installation way, flexible optional

- Air duct air conditioning has a variety of free and optional installation.
- Flexible customization according to the house type and user needs, to meet the high taste of the room settings.



### 300Pa ultra-high static pressure, cope with complex pipe length design 300Pa

### Low noise, more accurate throttling

Adopt 2000pls high-precision large-diameter deceleration EEV, adjust, lower noise, lower pressure loss.

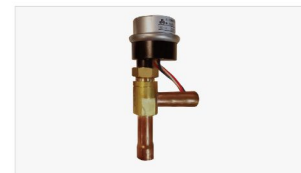

### Multiple external static pressure setting

DC inverter fan motor, it can realize step-less set speeds and 16 ESP conversion adjustment.

### Easy installation

External hanging electronic control box design, easy disassembly and installation.





## High Wall

### Built-in electronic expansion valve for easy installation (for AS\*\*\*MNERAB/AS\*\*\*MFERAB/AS\*\*\*MNERA/AS\*\*\*MFERA)

Built-in electronic expansion valve, easy to install. Dc fan motor, multi-wind speed, with multi-stage air supply angle to create comfortable airflow.



### Flexible wind control, quick cooling and heating

In heating and cooling condition, the unit can supply large volume air to quick warm and cold everywhere of indoor room.

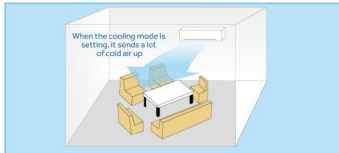
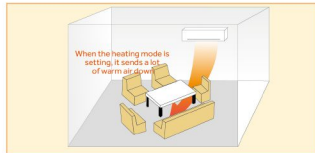

### New external electronic expansion valve models, for quiet needs (for AS\*\*\*MNERAC/AS\*\*\*MFERAC)

For quiet scenes, such as hotels and homes, we also provide electronic expansion valves installed outside the high wall to meet the low noise requirements.

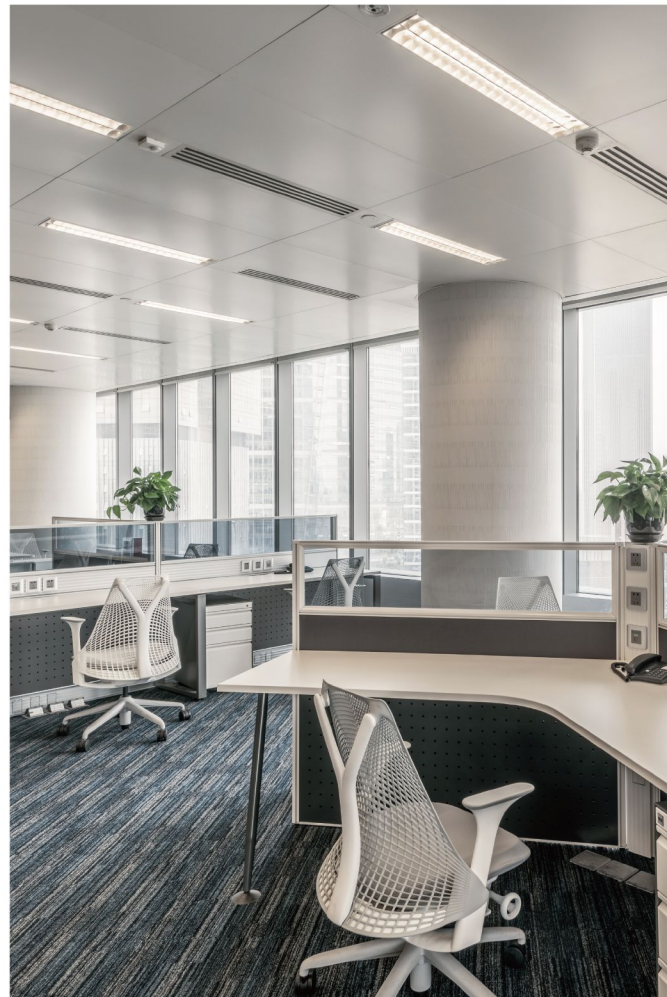

# 1-Way CASSETTE



DC fan motor



Butterfly wings airflow



Ultra thin design 185mm



Built-in high head  
drain pump max. 1000mm



HW-BA116ABK



YR-E17A



HW-BA101ABT



YR-E16B



YR-HRS01

# 1-Way CASSETTE

Model/Indoor unit		AB052MAERA		AB072MAERA		AB092MAERA		AB122MAERA	
Capacity	Cooling	kBtu/h	5.1	7.5	9.6	12.3			
		kW	1.5	2.2	2.8	3.6			
Heating		kBtu/h	5.8	8.5	10.9	13.6			
		kW	1.7	2.5	3.2	4			
Electrical Parameters	Power supply	PhV/Hz	1/220-230/50/60	1/220-230/50/60	1/220-230/50/60	1/220-230/50/60			
	Air flow (H/M/L)	m <sup>3</sup> /h	530/490/450	530/490/450	530/490/450	550/530/490			
Performance	Sound pressure level(H/M/L)	dB(A)	32/29/24	32/29/24	32/29/24	34/30/25			
	Sound power level(H/M/L)	dB(A)	46/43/38	46/43/38	46/43/38	48/44/39			
	External dimensions(W/D/H)	mm	875/505/185	875/505/185	875/505/185	875/505/185			
	Shipping dimensions(W/D/H)	mm	1028/581/270	1028/581/270	1028/581/270	1028/581/270			
Installation	Net/Shipping weight	kg	15.3/17.9	15.3/17.9	15.3/17.9	15.3/17.9			
	Refrigerant liquid pipe	mm	6.35	6.35	6.35	6.35			
	Refrigerant gas pipe	mm	9.52	9.52	9.52	12.7			
	Model Name		P1B-1050B	P1B-1050B	P1B-1050B	P1B-1050B			
Panel	External dimensions(W/D/H)	mm	1050/560/122	1050/560/122	1050/560/122	1050/560/122			
	Shipping dimensions(W/D/H)	mm	1133/623/197	1133/623/197	1133/623/197	1133/623/197			
	Net/Shipping weight	kg	5.3/8.3	5.3/8.3	5.3/8.3	5.3/8.3			
Controller		/	HW-BA101ABT	HW-BA101ABT	HW-BA101ABT	HW-BA101ABT			
		/	YR-E16B	YR-E16B	YR-E16B	YR-E16B			
	Wired(Optional)	/	HW-BA116ABK	HW-BA116ABK	HW-BA116ABK	HW-BA116ABK			
		/	YR-E17A	YR-E17A	YR-E17A	YR-E17A			
	Infrared(Optional)	/	YR-HRS01	YR-HRS01	YR-HRS01	YR-HRS01			

# 1-Way CASSETTE



DC fan motor

7.1  
kW

Capacity up to 7.1kW



Ultra thin design 185mm



Built-in high head  
drain pump max. 1000mm



HW-BA116ABK



YR-E17A



HW-BA101ABT



YR-E16B



YR-HRS01

## 1-Way CASSETTE

Model/Indoor unit		AB052MAERAD	AB072MAERAD	AB092MAERAD	AB122MAERAD	AB162MAERAD	AB182MAERAD	AB242MAERAD
Capacity	Cooling	kBtu/h 5.1	7.5	9.6	12.3	15.4	19.1	24.2
		kW 1.5	2.2	2.8	3.6	4.5	5.6	7.1
Heating		kBtu/h 5.8	8.5	10.9	13.7	17.1	21.5	27.3
		kW 1.7	2.5	3.2	4	5	6.3	8
Electrical Parameters	Power supply	Ph/V/Hz 1/220-240/50/60	1/220-240/50/60	1/220-240/50/60	1/220-240/50/60	1/220-240/50/60	1/220-240/50/60	1/220-240/50/60
	Air flow (H/M/L)	m <sup>3</sup> /h 540/400/270	540/400/270	540/400/270	650/510/390	700/530/410	820/660/510	870/690/510
	Sound pressure level(H/M/L)	dB(A) 38/33/28	38/33/28	38/33/28	40/36/31	41/36/32	40/36/32	42/36/32
	Sound power level(H/M/L)	dB 52/47/42	52/47/42	52/47/42	54/50/45	55/50/46	54/50/46	56/50/46
Performance	External dimensions(W/D/H)	mm 850/540/185	850/540/185	850/540/185	850/540/185	850/540/185	1170/540/185	1170/540/185
	Shipping dimensions(W/D/H)	mm 1043/648/270	1043/648/270	1043/648/270	1043/648/270	1043/648/270	1363/648/270	1363/648/270
	Net/Shipping weight	kg 20.5/24.7	20.5/24.7	20.5/24.7	20.8/24.9	21.3/25.5	26.0/31.4	27.1/32.5
Installation	Refrigerant liquid pipe	mm 6.35	6.35	6.35	6.35	6.35	6.35	9.52
	Refrigerant gas pipe	mm 9.52	9.52	9.52	12.7	12.7	12.7	15.88
	Panel/Model	/ P1B-1028B	P1B-1028B	P1B-1028B	P1B-1028B	P1B-1028B	P1B-1348B	P1B-1348B
Panel	External dimensions(W/D/H)	mm 1028/600/45	1028/600/45	1028/600/45	1028/600/45	1028/600/45	1348/600/45	1348/600/45
	Shipping dimensions(W/D/H)	mm 1143/688/170	1143/688/170	1143/688/170	1143/688/170	1143/688/170	1463/688/170	1463/688/170
	Net/Shipping weight	kg 3.9/8.0	3.9/8.0	3.9/8.0	3.9/8.0	3.9/8.0	5.1/9.8	5.1/9.8
Drain pipe	O-optional,S-standard,W/without	/ S	S	S	S	S	S	S
		/ YR-E17A YR-E16B	YR-E17A YR-E16B	YR-E17A YR-E16B	YR-E17A YR-E16B	YR-E17A YR-E16B	YR-E17A YR-E16B	YR-E17A YR-E16B
Controller	Wired(Optional)	/ HW-BA116ABK	HW-BA116ABK	HW-BA116ABK	HW-BA116ABK	HW-BA116ABK	HW-BA116ABK	HW-BA101ABT
		/ HW-BA101ABT	HW-BA101ABT	HW-BA101ABT	HW-BA101ABT	HW-BA101ABT	HW-BA101ABT	YRILJ-HQGS01
	Infrared(Optional)	/ YRILJ-HQGS01	YRILJ-HQGS01	YRILJ-HQGS01	YRILJ-HQGS01	YRILJ-HQGS01	YRILJ-HQGS01	YRILJ-HQGS01

\* Pending

# 2-Way CASSETTE



Compact design: only 220mm height



Ceiling antifouling design unique antifouling design



Built in high head drain pump



Quiet operation



\*1. In case of using YR-HD alone, RE-Q2 needs to be purchased.

\*2. HW-BA116ABK/YR-E17A and HW-BA101ABT have built-in infrared signal receiver. YR-E16B no such function.

## 2-Way CASSETTE

Model/Indoor unit		AB072MBERA		AB092MBERA		AB122MBERA		AB162MBERA		AB182MBERA		
Capacity	Cooling	kBtu/h	7.5	9.6	12.3	15.4	19.1					
		kW	2.2	2.8	3.6	4.5	5.6					
		Btu/h	8.5	10.9	13.6	17.1	21.5					
Electrical Parameters	Heating	kW	2.5	3.2	4	5	6.3					
		Power supply	PhV/Hz	1/220-230/50/60	1/220-230/50/60	1/220-230/50/60	1/220-230/50/60	1/220-230/50/60				
		Air flow (H)	m <sup>3</sup> /h	840/700/550	840/700/550	840/700/550	840/700/550	840/700/550				
Performance	Sound pressure level(H/M/L)	dB(A)	42/37/33	42/37/33	42/37/33	44/39/34	44/39/34					
		Sound power level(H/M/L)	dB(A)	55/50/46	55/50/46	55/50/46	57/52/47	57/52/47				
		External dimensions(W/D/H)	mm	817/620/220	817/620/220	817/620/220	817/620/220	817/620/220				
Installation	Shipping dimensions(W/D/H)	mm	1015/695/278	1015/695/278	1015/695/278	1015/695/278	1015/695/278					
		Net/Shipping weight	kg	21/23	21/23	21/23	21/23	21/23				
		Refrigerant liquid pipe	mm	6.35	6.35	6.35	6.35	6.35				
Panel	Refrigerant gas pipe	mm	9.52	9.52	12.7	12.7	12.7					
		Model name	P2B-1055IB	P2B-1055IB	P2B-1055IB	P2B-1055IB	P2B-1055IB					
		External dimensions(W/D/H)	mm	1055/680/68	1055/680/68	1055/680/68	1055/680/68	1055/680/68				
Controller	Shipping dimensions(W/D/H)	mm	1110/720/161	1110/720/161	1110/720/161	1110/720/161	1110/720/161					
		Net/Shipping weight	kg	7/8	7/8	7/8	7/8	7/8				
		Wired(Optional)	/	HW-BA101ABT	HW-BA101ABT	HW-BA101ABT	HW-BA101ABT	HW-BA101ABT				
Infrared(Optional)	YR-E16B	/	YR-E16B	YR-E16B	YR-E16B	YR-E16B						
		/	HW-BA116ABK	HW-BA116ABK	HW-BA116ABK	HW-BA116ABK	HW-BA116ABK					
		/	YR-E17A	YR-E17A	YR-E17A	YR-E17A	YR-E17A					
Infrared(Optional)	YR-HRS01	/	YR-HRS01	YR-HRS01	YR-HRS01	YR-HRS01						

\* Pending

# 2-Way CASSETTE



Compact design: only 220mm height



Ceiling antifouling design: unique antifouling design



DC fan motor

14 kW

Capacity up to 14kW



\*1. In case of using YR-HD alone, RE-Q2 needs to be purchased.

\*2. HW-BA116ABK, YR-E17A and HW-BA101ABT have built-in infrared signal receiver. YR-E16B no such function.

Model/Indoor unit		AB072MBERAD	AB092MBERAD	AB122MBERAD		AB162MBERAD	AB182MBERAD	AB242MBERAD	AB262MBERAD	AB302MBERAD	AB382MBERAD	AB482MBERAD
Capacity	Cooling	kBtu/h	7.5	9.6	12.3	15.4	19.1	24.2	27.3	30.7	38.2	47.8
		kW	2.2	2.8	3.6	4.5	5.6	7.1	8	9	11.2	14
Heating		kBtu/h	8.5	10.9	13.7	17.1	21.5	27.3	30.7	34.1	42.7	54.6
		kW	2.5	3.2	4	5	6.3	8	9	10	12.5	16
Electrical Performance	Power supply	Ph/V/Hz	1/220-230/50/60	1/220-230/50/60	1/220-230/50/60	1/220-230/50/60	1/220-230/50/60	1/220-230/50/60	1/220-230/50/60	1/220-230/50/60	1/220-230/50/60	1/220-230/50/60
	Air flow(H/M/L)	m <sup>3</sup> /h	650/600/550	850/600/550	710/610/550	780/650/550	860/710/610	970/780/650	1290/1155/1020	1390/1265/1140	1520/1405/1290	1700/1575/1450
Installation	External dimensions(W/D/H)	mm	1000/600/290	1000/600/290	1000/600/290	1000/600/290	1000/600/290	1000/600/290	1400/600/290	1400/600/290	1400/600/290	1400/600/290
	Shipping dimensions(W/D/H)	mm	1198/675/330	1198/675/330	1198/675/330	1198/675/330	1198/675/330	1198/675/330	1598/675/330	1598/675/330	1598/675/330	1598/675/330
	Net/Shipping weight	kg	38/40	38/40	38/40	38/40	38/40	38/40	45/48	45/48	45/48	45/48
	Refrigerant liquid pipe	mm	6.35	6.35	6.35	6.35	6.35	6.35	9.52	9.52	9.52	9.52
	Refrigerant gas pipe	mm	9.52	9.52	12.7	12.7	12.7	15.88	15.88	15.88	15.88	15.88
Panel	Model Name		P2B-1160B	P2B-1160B	P2B-1160B	P2B-1160B	P2B-1160B	P2B-1160B	P2B-1560B	P2B-1560B	P2B-1560B	P2B-1560B
	External dimensions(W/D/H)	mm	1160/666/60	1160/666/60	1160/666/60	1160/666/60	1160/666/60	1160/666/60	1560/666/60	1560/666/60	1560/666/60	1560/666/60
	Shipping dimensions(W/D/H)	mm	1215/706/152	1215/706/152	1215/706/152	1215/706/152	1215/706/152	1215/706/152	1615/706/152	1615/706/152	1615/706/152	1615/706/152
	Net/Shipping weight	kg	7.5/8.5	7.5/8.5	7.5/8.5	7.5/8.5	7.5/8.5	9.5/10.5	9.5/10.5	9.5/10.5	9.5/10.5	9.5/10.5
Controller	Wired(Optional)	/	HW-BA101ABT	HW-BA101ABT	HW-BA101ABT	HW-BA101ABT	HW-BA101ABT	HW-BA101ABT	HW-BA101ABT	HW-BA101ABT	HW-BA101ABT	HW-BA101ABT
		/	YR-E16B	YR-E16B	YR-E16B	YR-E16B	YR-E16B	YR-E16B	YR-E16B	YR-E16B	YR-E16B	YR-E16B
		/	HW-BA116ABK	HW-BA116ABK	HW-BA116ABK	HW-BA116ABK	HW-BA116ABK	HW-BA116ABK	HW-BA116ABK	HW-BA116ABK	HW-BA116ABK	HW-BA116ABK
	Infrared(Optional)	/	YR-E17A	YR-E17A	YR-E17A	YR-E17A	YR-E17A	YR-E17A	YR-E17A	YR-E17A	YR-E17A	YR-E17A
		/	YR-HRS01	YR-HRS01	YR-HRS01	YR-HRS01	YR-HRS01	YR-HRS01	YR-HRS01	YR-HRS01	YR-HRS01	YR-HRS01

\* Pending

# 2-Way CASSETTE

# Compact CASSETTE



DC fan motor



Fresh air outlet



New panel design  
620\*620mm



Low sound level



YR-E17A YR-E16B YR-HRS01 YR-HQS01

Compact CASSETTE

Model/Indoor unit		AB052MCERA(M)	AB072MCERA(M)	AB092MCERA(M)	AB122MCERA(M)	AB162MCERA(M)	AB182MCERA(M)
Capacity	Cooling	kBtu/h 5.1	7.5	9.5	12.3	15.3	19.1
	kW	1.5	2.2	2.8	3.6	4.5	5.6
Heating	kBtu/h	5.8	8.5	10.9	13.6	17.1	21.5
	kW	1.7	2.5	3.2	4	5	6.3
Electrical Parameters	Power supply	Ph/V/Hz	1/220-240/50/60	1/220-240/50/60	1/220-240/50/60	1/220-240/50/60	1/220-240/50/60
	Air flow (H/M/L)	m <sup>3</sup> /h	520/450/400	520/450/400	520/450/400	520/450/400	650/520/450
Performance	Sound pressure level(H/M/L)	dB(A)	32/30/29	32/30/29	32/30/29	33/30/29	34/32/30
	Sound power level(H/M/L)	dB(A)	46/44/43	46/44/43	46/44/43	47/44/43	48/46/44
Installation	External dimensions(W/D/H)	mm	570/570/260	570/570/260	570/570/260	570/570/260	570/570/260
	Shipping dimensions(W/D/H)	mm	718/680/580	718/680/580	718/680/580	718/680/580	718/680/580
Panel	Net/Shipping weight	kg	16/19	16/19	19/22	19/22	19/22
	Refrigerant liquid pipe	mm	6.35	6.35	6.35	6.35	6.35
	Refrigerant gas pipe	mm	9.52	9.52	12.7	12.7	12.7
Controller	Model Name	PB-620KB /PB-620KB(H)	PB-620KB /PB-620KB(H)	PB-620KB /PB-620KB(H)	PB-620KB /PB-620KB(H)	PB-620KB /PB-620KB(H)	PB-620KB /PB-620KB(H)
	External dimensions(W/D/H)	mm	620/620/60	620/620/60	620/620/60	620/620/60	620/620/60
	Shipping dimensional(W/D/H)	mm	660/660/115	660/660/115	660/660/115	660/660/115	660/660/115
Wired(Optional)	/	YR-E16B	YR-E16B	YR-E16B	YR-E16B	YR-E16B	YR-E16B
	/	YR-E17A	YR-E17A	YR-E17A	YR-E17A	YR-E17A	YR-E17A
Infrared(Optional)	/	YR-HQS01	YR-HQS01	YR-HQS01	YR-HQS01	YR-HQS01	YR-HQS01
	/	YR-HRS01	YR-HRS01	YR-HRS01	YR-HRS01	YR-HRS01	YR-HRS01



# RoundWay CASSETTE



DC fan motor



Innovative 4 independent air flow control



Unique round-way air outlet, no blind spot



6 adjustable lower positions, 15kg per flow combinations



YR-E17A YR-E16B YR-HRS01 YR-HQS01

RoundWay  
CASSETTE



Model/Indoor unit		AB072MRERA	AB092MRERA	AB122MRERA	AB162MRERA	AB182MRERA	AB242MRERA	AB282MRERA	AB302MRERA	AB382MRERA	AB462MRERA	AB602MRERA	
Capacity	Cooling	kBtu/h	7.5	9.5	12.3	15.3	19.1	24.2	27.3	30.7	38.2	47.7	54.6
		kW	2.2	2.8	3.6	4.5	5.6	7.1	8	9	11.2	14	16
	Heating	Btu/h	8.5	10.9	13.6	17.1	21.5	27.3	30.7	34.1	42.6	54.6	61.2
		kW	2.5	3.2	4	5	6.3	8	9	10	12.5	16	18
Electrical Parameters	Power supply	Ph-V/Hz	1/220-230/50/60	1/220-230/50/60	1/220-230/50/60	1/220-230/50/60	1/220-230/50/60	1/220-230/50/60	1/220-230/50/60	1/220-230/50/60	1/220-230/50/60	1/220-230/50/60	
Performance	Air flow (H)	m <sup>3</sup> /h	1000/810/620	1000/810/620	1000/810/620	1000/810/620	1380/1190/1000	1380/1190/1000	2050/1860/1670	2050/1860/1670	2100/1910/1720	2100/1910/1720	
	Sound pressure level(H/M/L)	dB(A)	30/27/25	30/27/25	30/27/25	32/29/27	35/30/29	35/34/31	37/35/31	37/35/31	37/35/31	44/40/36	44/40/36
Installation	External dimensions(W/D/H)	mm	840/840/180	840/840/180	840/840/180	840/840/180	840/840/204	840/840/204	840/840/246	840/840/246	840/840/288	840/840/288	
	Shipping dimensions(W/D/H)	mm	983/983/268	983/983/268	983/983/268	983/983/268	983/983/290	983/983/290	983/983/331	983/983/331	983/983/373	983/983/373	
	Net/Shipping weight	kg	25/28	25/28	25/28	25/28	27/30	27/30	31/36	31/36	33/38	33/38	
	Refrigerant liquid pipe	mm	6.35	6.35	6.35	6.35	9.52	9.52	9.52	9.52	9.52	9.52	
	Refrigerant gas pipe	mm	9.52	9.52	12.7	12.7	12.7	15.88	15.88	15.88	15.88	15.88	
Panel	Model name		PB-950K/PB-950KH / PB-950KB/PB-950KBH		PB-950K/PB-950KBH	PB-950K/PB-950KBH	PB-950K/PB-950KBH	PB-950K/PB-950KBH	PB-950K/PB-950KBH	PB-950K/PB-950KBH	PB-950K/PB-950KBH	PB-950K/PB-950KBH	
	External dimensions(W/D/H)	mm	950/950/50	950/950/50	950/950/50	950/950/50	950/950/50	950/950/50	950/950/50	950/950/50	950/950/50	950/950/50	
	Shipping dimensions(W/D/H)	mm	1013/1025/123	1013/1025/123	1013/1025/123	1013/1025/123	1013/1025/123	1013/1025/123	1013/1025/123	1013/1025/123	1013/1025/123	1013/1025/123	
	Net/Shipping weight	kg	6.5/9	6.5/9	6.5/9	6.5/9	6.5/9	6.5/9	6.5/9	6.5/9	6.5/9	6.5/9	
Controller	Wired(Optional)	/	YR-E17A	YR-E17A	YR-E17A	YR-E17A	YR-E17A	YR-E17A	YR-E17A	YR-E17A	YR-E17A	YR-E17A	
		/	YR-E16B	YR-E16B	YR-E16B	YR-E16B	YR-E16B	YR-E16B	YR-E16B	YR-E16B	YR-E16B	YR-E16B	
	Infrared(Optional)	/	YR-HQS01	YR-HQS01	YR-HQS01	YR-HQS01	YR-HQS01	YR-HQS01	YR-HQS01	YR-HQS01	YR-HQS01	YR-HQS01	
		YR-HRS01	YR-HRS01	YR-HRS01	YR-HRS01	YR-HRS01	YR-HRS01	YR-HRS01	YR-HRS01	YR-HRS01	YR-HRS01	YR-HRS01	

# 4-Way CASSETTE



700x700mm panel design



Built-in high head drain pump



Pre-set fresh air inlet



Quiet operation



HW-BA116ABK YR-E17A HW-BA101ABT YR-E16B YR-HRS01

# 4-Way CASSETTE

Model/Indoor unit		AB052MCERA		AB072MCERA		AB092MCERA		AB122MCERA		AB162MCERA		AB182MCERA(C)	
Capacity	Cooling	kBtu/h	5.1	7.5	12.3	9.5	12.3	19.1	15.3	19.1	15.3	19.1	19.1
	Heating	kW	1.5	2.2	2.8	3.6	4.5	5.6	6.3	8.5	10.9	13.6	17.1
Electrical Parameters	Power supply	Ph/V/Hz	1/220-230/50/60	1/220-230/50/60	1/220-230/50/60	1/220-230/50/60	1/220-230/50/60	1/220-230/50/60	1/220-230/50/60	1/220-230/50/60	1/220-230/50/60	1/220-230/50/60	1/220-230/50/60
	Air flow (l/s)	m <sup>3</sup> /h	650/540/430	700/590/480	700/590/480	700/590/480	700/590/480	700/590/480	700/590/480	700/590/480	700/590/480	700/590/480	700/590/480
Performance	Sound pressure level(H/M/L)	dB(A)	31/29/28	32/30/29	32/30/29	32/30/29	33/30/29	33/30/29	33/30/29	33/30/29	33/30/29	33/30/29	33/30/29
	Sound power level(H/M/L)	dB(A)	45/43/42	46/44/43	46/44/43	46/44/43	46/44/43	47/44/43	47/44/43	47/44/43	47/44/43	47/44/43	47/44/43
Installation	External dimensions(W/D/H)	mm	570/570/260	570/570/260	570/570/260	570/570/260	570/570/260	570/570/260	570/570/260	570/570/260	570/570/260	570/570/260	570/570/260
	Shipping dimensions(W/D/H)	mm	718/680/380	718/680/380	718/680/380	718/680/380	718/680/380	718/680/380	718/680/380	718/680/380	718/680/380	718/680/380	718/680/380
Panel	Net/Shipping weight	kg	16/19	16/19	16/19	19/22	19/22	19/22	19/22	19/22	19/22	19/22	19/22
	Refrigerant liquid pipe	mm	6.35	6.35	6.35	6.35	6.35	6.35	6.35	6.35	6.35	6.35	
	Refrigerant gas pipe	mm	9.52	9.52	9.52	12.7	12.7	12.7	12.7	12.7	12.7	12.7	
Controller	Model name		PB-700B	PB-700B	PB-700B	PB-700B	PB-700B	PB-700B	PB-700B	PB-700B	PB-700B	PB-700B	PB-700B
	External dimensions(W/D/H)	mm	700/700/60	700/700/60	700/700/60	700/700/60	700/700/60	700/700/60	700/700/60	700/700/60	700/700/60	700/700/60	700/700/60
	Shipping dimensions(W/D/H)	mm	740/740/115	740/740/115	740/740/115	740/740/115	740/740/115	740/740/115	740/740/115	740/740/115	740/740/115	740/740/115	740/740/115
	Net/Shipping weight	kg	2.8/4.5	2.8/4.5	2.8/4.5	2.8/4.5	2.8/4.5	2.8/4.5	2.8/4.5	2.8/4.5	2.8/4.5	2.8/4.5	2.8/4.5
Controller	Wired(Optional)	/	HW-BA101ABT	HW-BA101ABT	HW-BA101ABT	HW-BA101ABT	HW-BA101ABT	HW-BA101ABT	HW-BA101ABT	HW-BA101ABT	HW-BA101ABT	HW-BA101ABT	HW-BA101ABT
	Infrared(Optional)	/	YR-E16B	YR-E16B	YR-E16B	YR-E16B	YR-E16B	YR-E16B	YR-E16B	YR-E16B	YR-E16B	YR-E16B	YR-E16B
	Wired(Optional)	/	HW-BA116ABK	HW-BA116ABK	HW-BA116ABK	HW-BA116ABK	HW-BA116ABK	HW-BA116ABK	HW-BA116ABK	HW-BA116ABK	HW-BA116ABK	HW-BA116ABK	HW-BA116ABK
	Infrared(Optional)	/	YR-E17A	YR-E17A	YR-E17A	YR-E17A	YR-E17A	YR-E17A	YR-E17A	YR-E17A	YR-E17A	YR-E17A	YR-E17A
Controller	Wired(Optional)	/	YR-HRS01	YR-HRS01	YR-HRS01	YR-HRS01	YR-HRS01	YR-HRS01	YR-HRS01	YR-HRS01	YR-HRS01	YR-HRS01	YR-HRS01
	Infrared(Optional)	/	YR-HRS01	YR-HRS01	YR-HRS01	YR-HRS01	YR-HRS01	YR-HRS01	YR-HRS01	YR-HRS01	YR-HRS01	YR-HRS01	YR-HRS01

# 4-Way CASSETTE



700x700mm panel design



Built-in high head drain pump



Pre-set fresh air inlet



Quiet operation



HW-BA116ABK YR-E17A HW-BA101ABT YR-E16B YR-HRS01

## 4-Way CASSETTE

Model/Indoor unit		AB182MNERA	AB242MNERA	AB282MNERA	AB302MNERA	AB382MNERA	AB482MNERA	AB602MNERA
Capacity	Cooling	kBtu/h 19.1	24.2	27.3	30.7	38.2	47.8	54.6
	kW	5.6	7.1	8	9	11.2	14	16
Heating	Btu/h	21.5	27.3	30.7	34.1	42.7	54.6	61.2
	kW	6.3	8	9	10	12.5	16	18
Electrical Parameters	Power supply	Ph/V/Hz 1,220-230/50/60	1,220-230/50/60	1,220-230/50/60	1,220-230/50/60	1,220-230/50/60	1,220-230/50/60	1,220-230/50/60
	Air flow (H)	m <sup>3</sup> /h 1000/810/620	1580/1190/1000	1580/1190/1000	2050/1860/1670	2050/1860/1670	2100/1910/1720	2100/1910/1720
Performance	Sound pressure level(H/M/L)	dB(A) 33/30/29	35/34/31	37/35/31	37/35/31	37/35/31	44/40/36	44/40/36
	Sound power level(H/M/L)	dB(A) 47/44/43	49/48/45	51/49/45	51/49/45	51/49/45	58/54/50	58/54/50
Installation	External dimensions(W/D/H)	mm 840/840/180	840/840/204	840/840/204	840/840/246	840/840/246	840/840/288	840/840/288
	Shipping dimensions(W/D/H)	mm 983/983/268	983/983/290	983/983/290	983/983/331	983/983/331	983/983/373	983/983/373
Panel	Net/Shipping weight	kg 25/28	25/28	25/28	25/28	25/28	25/28	25/28
	Refrigerant liquid pipe	mm 6.35	9.52	9.52	9.52	9.52	9.52	9.52
	Refrigerant gas pipe	mm 12.7	15.88	15.88	15.88	15.88	15.88	15.88
	Model name	PB-950JB	PB-950JB	PB-950JB	PB-990JB	PB-990JB	PB-990JB	PB-990JB
Controller	External dimensions(W/D/H)	mm 950/950/60	950/950/60	950/950/60	950/950/60	950/950/60	950/950/60	950/950/60
	Shipping dimensions(W/D/H)	mm 992/992/115	992/992/115	992/992/115	992/992/115	992/992/115	992/992/115	992/992/115
	Net/Shipping weight	kg 6/7.5	6/7.5	6/7.5	6/7.5	6/7.5	6/7.5	6/7.5
Controller	Wired(Options)	/	HW-BA101ABT	HW-BA101ABT	HW-BA101ABT	HW-BA101ABT	HW-BA101ABT	HW-BA101ABT
	/	/	YR-E16B	YR-E16B	YR-E16B	YR-E16B	YR-E16B	YR-E16B
	/	/	HW-BA116ABK	HW-BA116ABK	HW-BA116ABK	HW-BA116ABK	HW-BA116ABK	HW-BA116ABK
	/	/	YR-E17A	YR-E17A	YR-E17A	YR-E17A	YR-E17A	YR-E17A
Infrared (Optional)	/	YR-HRS01	YR-HRS01	YR-HRS01	YR-HRS01	YR-HRS01	YR-HRS01	



CONVERTIBLE



DC fan motor



Flexible installation, on the floor or on the ceiling



Automatic horizontal and vertical swing



Reserved fresh air inlet



Model/Indoor unit		AC092MDERA	AC122MDERA	AC162MDERA	AC182MDERA	AC242MDERA	AC282MDERA	AC302MDERA	AC382MDERA	AC482MDERA	
Capacity	Cooling	kBtu/h	9.5	12.3	15.4	19.1	24.2	27.3	30.7	38.2	48.0
		kW	2.8	3.6	4.5	5.6	7.1	8	9	11.2	14.0
	Heating	Btu/h	10.9	13.6	17.1	21.5	27.3	30.7	34.1	42.6	55.0
		kW	3.2	4.0	5	6.3	8	9	10	12.5	16.0
Electrical Parameters	Power supply	Ph/V/Hz	1,220-230.50/60	1,220-230.50/60	1,220-230.50/60	1,220-230.50/60	1,220-230.50/60	1,220-230.50/60	1,220-230.50/60	1,220-230.50/60	
	Air flow (l/s)	m <sup>3</sup> /h	820/750/690	820/750/690	950/820/690	950/820/690	1420/1270/1240	1570/1420/1240	1570/1420/1240	2110/1990/1750	2110/1990/1750
Performance	Sound pressure level(H/M/L)	dB(A)	38/36/34	38/36/34	42/38/35	42/38/35	46/44/41	47/44/41	47/44/41	50/46/43	50/46/43
	Sound power level(H/M/L)	dB(A)	52/50/47	52/50/47	55/51/48	55/51/48	60/58/54	61/58/55	61/58/55	63/60/57	63/60/57
	External dimensions(W/D/H)	mm	1000/230/680	1000/230/680	1000/230/680	1000/230/680	1325/230/680	1325/230/680	1325/230/680	1650/230/680	1650/230/680
Installation	Shipping dimensions(W/D/H)	mm	1100/305/779	1100/305/779	1100/305/779	1100/305/779	1425/305/779	1425/305/779	1425/305/779	1750/305/779	1750/305/779
	Net/Shipping weight	kg	27.9/33.6	27.9/33.6	27.9/33.6	27.9/33.6	35.8/42.1	35.8/42.1	35.8/42.1	43.5/50.5	43.5/50.5
	Refrigerant liquid pipe	mm	6.35	6.35	6.35	6.35	9.52	9.52	9.52	9.52	9.52
	Refrigerant gas pipe	mm	9.52	12.7	12.7	12.7	15.88	15.88	15.88	15.88	15.88
	Controller	Wired(Optional)	/	HW-BA101ABT	HW-BA101ABT	HW-BA101ABT	HW-BA101ABT	HW-BA101ABT	HW-BA101ABT	HW-BA101ABT	HW-BA101ABT
/			YR-E16B	YR-E16B	YR-E16B	YR-E16B	YR-E16B	YR-E16B	YR-E16B	YR-E16B	YR-E16B
/			HW-BA116ABK	HW-BA116ABK	HW-BA116ABK	HW-BA116ABK	HW-BA116ABK	HW-BA116ABK	HW-BA116ABK	HW-BA116ABK	HW-BA116ABK
/			YR-E17A	YR-E17A	YR-E17A	YR-E17A	YR-E17A	YR-E17A	YR-E17A	YR-E17A	YR-E17A
Infrared(Optional)		/	YR-HRS01	YR-HRS01	YR-HRS01	YR-HRS01	YR-HRS01	YR-HRS01	YR-HRS01	YR-HRS01	YR-HRS01

# Slim DUCT



DC fan motor



Friendly design of rear or bottom air return



Super slim design, only 185mm



Built-in high head drain pump

# (0/15/30Pa)



YR-E17A



HW-BA10ABT



YR-E16B



YR-HRS01

\*1. HW-BA116ABK/YR-E17A and HW-BA10ABT have built-in infrared signal receiver. YR-E16B no such function.  
 \*2. The units with panel can directly use the remote controller YR-HD and no need to purchase RE-G2

# Slim DUCT (0/15/30Pa)

Model/Indoor unit		AD05ZMSERA(D)	AD07ZMSERA(D)	AD09ZMSERA(D)	AD12ZMSERA(D)	AD16ZMSERA(D)	AD18ZMSERA(D)	AD24ZMSERA(D)
Capacity	Cooling	kBtu/h	5.1	7.5	12.3	15.3	19.1	24.2
		kW	1.5	2.2	3.6	4.5	5.6	7.1
	Heating	kBtu/h	5.8	8.5	10.9	13.6	17.1	21.5
		kW	1.7	2.5	3.2	4	5	6.3
Electrical Parameters	Power supply	PhV/Hz	1/220-230/50/60	1/220-230/50/60	1/220-230/50/60	1/220-230/50/60	1/220-230/50/60	1/220-230/50/60
	Air flow (H/M/L)	m <sup>3</sup> /h	430/570/510	480/420/360	480/420/360	550/430/370	600/540/460	800/690/580
	Sound pressure level(H/M/L)	dB(A)	26/22/19	27/23/20	27/23/20	30/27/24	32/29/26	33/30/27
Performance	Sound power level(H/M/L)	dB(A)	40/36/33	41/37/34	41/37/34	46/43/40	47/44/41	50/47/43
	External dimensions(W/D/H)	mm	850/420/185	850/420/185	850/420/185	850/420/185	850/420/185	1170/420/185
	Shipping dimensions(W/D/H)	mm	1045/540/270	1045/540/270	1045/540/270	1045/540/270	1045/540/270	1365/540/270
Installation	Net/Shipping weight	kg	11.5/21.5	17.5/22.5	17.5/22.5	17.5/22.5	18.5/23.5	24/30
	Refrigerant liquid pipe	mm	6.35	6.35	6.35	6.35	6.35	9.52
	Refrigerant gas pipe	mm	9.52	9.52	9.52	12.7	12.7	12.7
	Static Pressure(Standard/Max.)	Pa	0/15/30	0/15/30	0/15/30	0/15/30	0/15/30	0/15/30
	Panel model	/	P1B-890A/D	P1B-890A/D	P1B-890A/D	P1B-890A/D	P1B-890A/D	P1B-1210A/D
	External dimensions(W/D/H)	mm	890/190/100 (outlet panel)	890/190/100 (outlet panel)	890/190/100 (outlet panel)	890/190/100 (outlet panel)	890/190/100 (outlet panel)	1210/190/100 (outlet panel)
Panel	External dimensions(W/D/H)	mm	890/290.5/32.4 (inlet panel)	890/290.5/32.4 (inlet panel)	890/290.5/32.4 (inlet panel)	890/290.5/32.4 (inlet panel)	1210/290.5/32.4 (inlet panel)	1210/290.5/32.4 (inlet panel)
	Shipping dimensions(W/D/H)	mm	938/335/220	938/335/220	938/335/220	938/335/220	938/335/220	1258/335/220
	Net/Shipping weight	Kg	4/5	4/5	4/5	4/5	4/5	5/6
Drain pump	O-optional/S-standard/W-without		S	S	S	S	S	S
		/	HW-BA101ABT	HW-BA101ABT	HW-BA101ABT	HW-BA101ABT	HW-BA101ABT	HW-BA101ABT
Controller	Wired(Optional)	/	YR-E16B	YR-E16B	YR-E16B	YR-E16B	YR-E16B	YR-E16B
		/	YR-E17A	YR-E17A	YR-E17A	YR-E17A	YR-E17A	YR-E17A
	Infrared (Optional)	/	YR-HRS01	YR-HRS01	YR-HRS01	YR-HRS01	YR-HRS01	YR-HRS01



# Slim DUCT

Slim

# (0/30Pa)



Reserved fresh air inlet



Front/bottom air return



Super-slim design, only 185mm



Built-in high head drain pump

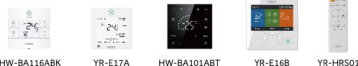

HW-BA116ABK

YR-E17A

HW-BA101ABT

YR-E16B

YR-HRS01

\*1. HW-BA116ABK/YR-E17A and HW-BA101ABT have built-in infrared signal receiver. YR-E16B no such function.  
2. The units with panel can directly use the remote controller YR-HD and no need to purchase RE-02.

# Slim DUCT (0/30Pa)

Model/Indoor unit		AD02MSERA	AD07MSERA	AD092MSERA	AD122MSERA	AD162MSERA	AD182MSERA	AD242MSERA	
Capacity	Cooling	kBtu/h	5.1	7.5	9.5	12.3	15.3	24.2	
		kW	1.5	2.2	2.8	3.6	4.5	7.1	
	Heating	kBtu/h	5.8	8.5	10.9	13.6	17.1	27.3	
		kW	1.7	2.5	3.2	4	5	8	
Electrical Parameters	Power supply	Ph/V/Hz	1/220-230/50/60	1/220-230/50/60	1/220-230/50/60	1/220-230/50/60	1/220-230/50/60	1/220-230/50/60	
	Air flow (W/H/L)	m <sup>3</sup> /h	430/370/310	480/420/360	480/420/360	550/430/370	600/440/460	800/690/580	930/850/750
Performance	Sound pressure level(H/M/L)	dB(A)	26/23/20	27/24/21	27/24/21	33/30/27	33/30/28	36/33/31	
	Sound power level(H/M/L)	dB(A)	40/37/34	41/38/35	41/38/35	44/42/39	47/44/41	47/44/42	50/47/44
	External dimensions(WD/H)	mm	850/420/185	850/420/185	850/420/185	850/420/185	850/420/185	1170/420/185	1170/420/185
Installation	Shipping dimensions(WD/H)	mm	1045/540/270	1045/540/270	1045/540/270	1045/540/270	1045/540/270	1365/540/270	1365/540/270
	Net/Shipping weight	kg	16.5/21.5	17.5/22.5	17.5/22.5	17.5/22.5	18.5/23.5	22.2/28.2	24/30
	Refrigerant liquid pipe	mm	6.35	6.35	6.35	6.35	6.35	6.35	9.52
	Refrigerant gas pipe	mm	9.52	9.52	9.52	12.7	12.7	12.7	15.88
	Static Pressure(Standard/Max.)	Pa	0/30	0/30	0/30	0/30	0/30	0/30	0/30
	Panel model	/	P1B-890A/D	P1B-890A/D	P1B-890A/D	P1B-890A/D	P1B-890A/D	P1B-1210A/D	P1B-1210A/D
Panel	External dimensions(WD/H)	mm	890/190/100 (outlet panel)	890/190/100 (outlet panel)	890/190/100 (outlet panel)	890/190/100 (outlet panel)	890/190/100 (outlet panel)	1210/190/100 (outlet panel)	1210/190/100 (outlet panel)
	External dimensions(WD/H)	mm	890/290/532 (inlet panel)	890/290/532 (inlet panel)	890/290/532 (inlet panel)	890/290/532 (inlet panel)	890/290/532 (inlet panel)	1210/290/532 (inlet panel)	1210/290/532 (inlet panel)
	Shipping dimensions(WD/H)	mm	938/335/220	938/335/220	938/335/220	938/335/220	938/335/220	1258/335/220	1258/335/220
Net/Shipping weight		Kg	4/5	4/5	4/5	4/5	4/5	5/6	
		Kg	5	5	5	5	5	5	
Drain pump	O-option/S-standard/W-without	/	/	/	/	/	/	/	
			HW-BA101ABT	HW-BA101ABT	HW-BA101ABT	HW-BA101ABT	HW-BA101ABT	HW-BA101ABT	
Controller	Wired(Optional)	/	/	/	/	/	/	/	
			YR-E16B	YR-E16B	YR-E16B	YR-E16B	YR-E16B	YR-E16B	
			HW-BA116ABK	HW-BA116ABK	HW-BA116ABK	HW-BA116ABK	HW-BA116ABK	HW-BA116ABK	
	Infrared(Optional)	/	/	/	/	/	/	/	
		YR-E17A	YR-E17A	YR-E17A	YR-E17A	YR-E17A	YR-E17A		
		YR-HRS01	YR-HRS01	YR-HRS01	YR-HRS01	YR-HRS01	YR-HRS01		

# Medium ESP DUCT

# (50/100Pa)

50/100Pa

50/100Pa



Built-in drain pump







Only 28mm thick

50/60Hz

All models can realize 50/60Hz



HW-BA116ABK    YR-E17A    HW-BA101ABT    YR-E16B    YR-HRS01

\*1. HW-BA116ABK, YR-E17A and HW-BA101ABT have built-in infrared signal receiver. YR-E16B no such function.

Model/Indoor unit		AD052MJERAB	AD072MJERAB	AD092MJERAB		AD122MJERAB	AD162MJERAB	AD182MJERAB	AD242MJERAB	AD262MJERAB	AD302MJERA	AD362MJERA	AD482MJERA	AD542MJERA
Capacity	Cooling	kBtu/h	5.1	7.5	9.5	12.3	15.3	19.1	24.2	27.3	30.7	38.2	47.8	54.6
		kW	1.5	2.2	2.8	3.6	4.5	5.6	7.1	8	9	11.2	14	16
	Heating	Btu/h	5.8	8.5	10.9	15.6	17.1	21.5	27.3	30.7	34.1	44.4	55.6	61.4
		kW	1.7	2.5	3.2	4	5	6.3	8	9	10	13	16.3	18
Electrical Parameters	Power supply	PH/VR/Hz 1/220-240/50/60 1/220-240/50/60 1/220-240/50/60 1/220-240/50/60				1/220-240/50/60	1/220-240/50/60	1/220-240/50/60	1/220-240/50/60	1/220-240/50/60	1/220-230/50/60	1/220-230/50/60	1/220-230/50/60	1/220-230/50/60
	Air flow (F/H)	m <sup>3</sup> /h 630/510/424 630/510/424 630/510/424				630/510/424	740/550/442	980/840/760	1174/1080/960	1500/1180/930	1700/1300/900	2000/1700/1250	2000/1700/1250	2000/1700/1250
Performance	Sound pressure level(H/M/L)	dB(A) 35/33/31 35/33/31 35/33/31				35/33/31	35/33/31	36/34/32	40/37/34	42/38/34	42/39/35	43/40/35	43/40/35	43/40/35
	Sound power level(H/M/L)	dB(A) 39/37/35 39/37/35 39/37/35				39/37/35	39/37/35	40/38/36	44/41/38	46/42/38	46/33/39	47/44/39	47/44/39	
	External dimensions(W/D/H)	mm 700/700/248 700/700/248 700/700/248				700/700/248	700/700/248	1100/700/248	1100/700/248	1100/700/248	1500/700/248	1500/700/248	1500/700/248	1500/700/248
	Shipping dimensions(W/D/H)	mm 932/835/280 932/835/280 932/835/280				932/835/280	932/835/280	1332/835/280	1332/835/280	1332/835/280	1698/857/305	1698/857/305	1698/857/305	1698/857/305
Installation	Net/Shipping weight	kg 27/32 27/32 27/32				27/32	28.5/33.5	36.8/43.5	37/43.4	37/43.6	39.4/45.4	48.3/56.5	51.3/59.5	51.3/59.5
	Refrigerant liquid pipe	mm 6.35 6.35 6.35				6.35	6.35	6.35	9.52	9.52	9.52	9.52	9.52	9.52
	Refrigerant gas pipe	mm 9.52 9.52 9.52				12.7	12.7	12.7	15.88	15.88	15.88	15.88	15.88	15.88
	Static Pressure(Standard/Max)	Pa 50/100 50/100 50/100				50/100	50/100	50/100	50/100	50/100	50/100	50/100	50/100	50/100
Drain pump	O-optional/S-standard/W-without	S S S S				S	S	S	S	S	S	S	S	S
	Wired/Optional	/	/	/	/	/	/	/	/	/	/	/	/	/
Controller	Wired/Optional	/	HW-BA101ABT	HW-BA101ABT	HW-BA101ABT	HW-BA101ABT	HW-BA101ABT	HW-BA101ABT	HW-BA101ABT	HW-BA101ABT	HW-BA101ABT	HW-BA101ABT	HW-BA101ABT	HW-BA101ABT
		/	YR-E16B	YR-E16B	YR-E16B	YR-E16B	YR-E16B	YR-E16B	YR-E16B	YR-E16B	YR-E16B	YR-E16B	YR-E16B	YR-E16B
	/	YR-E17A	YR-E17A	YR-E17A	YR-E17A	YR-E17A	YR-E17A	YR-E17A	YR-E17A	YR-E17A	YR-E17A	YR-E17A	YR-E17A	YR-E17A
	/	HW-BA116ABK	HW-BA116ABK	HW-BA116ABK	HW-BA116ABK	HW-BA116ABK	HW-BA116ABK	HW-BA116ABK	HW-BA116ABK	HW-BA116ABK	HW-BA116ABK	HW-BA116ABK	HW-BA116ABK	HW-BA116ABK
Infrared/Optional	/	YR-HRS01	YR-HRS01	YR-HRS01	YR-HRS01	YR-HRS01	YR-HRS01	YR-HRS01	YR-HRS01	YR-HRS01	YR-HRS01	YR-HRS01	YR-HRS01	

Medium ESP  
DUCT (50/100Pa)

# High ESP DUCT



DC fan motor



Built-in drain pump



Only 28mm thick



All models can realize 50/60Hz

# (20/200Pa)



HW-BA116ABK YR-E17A HW-BA101ABT YR-E16B YR-HRS01  
\*1. HW-BA116ABK, YR-E17A and HW-BA101ABT have built-in infrared signal receiver. YR-E16B no such function

High ESP  
**DUCT** (20/200Pa)

Model/Indoor unit	AD02MJERAD/AD07MJERAD/AD092MJERAD			AD122MJERAD	AD162MJERAD	AD182MJERAD	AD242MJERAD	AD262MJERAD	AD302MJERAD	AD382MJERAD	AD482MJERAD	AD542MJERAD		
Capacity	Cooling	HP	0.5	0.8	1.0	1.25	1.7	2.0	2.5	3.0	3.2	4.0	5.0	6.0
		kBtu/h	5.1	7.5	9.6	12.3	15.3	19.1	24.2	27.3	30.7	38.2	47.8	54.6
	Heating	kW	1.5	2.2	2.8	3.6	4.5	5.6	7.1	8	9	11.2	14	16
		kBtu/h	5.8	8.5	10.9	13.7	17	21.5	27.3	30.7	34.1	44.4	55.6	61.4
Electrical Parameters	Power supply	Ph/V/Hz	1/220-240/50/60	1/220-240/50/60	1/220-240/50/60	1/220-240/50/60	1/220-240/50/60	1/220-240/50/60	1/220-240/50/60	1/220-240/50/60	1/220-240/50/60	1/220-240/50/60	1/220-240/50/60	
		Net Product	mm	700/700/248	700/700/248	700/700/248	700/700/248	1100/700/248	1100/700/248	1100/700/248	1500/700/248	1500/700/248	1500/700/248	
Dimensions	Shipping Product	mm	932/835/280	932/835/280	932/835/280	932/835/280	932/835/280	1332/835/280	1332/835/280	1332/835/280	1698/857/305	1698/857/305	1698/857/305	
		Weight	kg	27/32	27/32	27/32	27/32	28.5/33.5	36.8/43.4	36.8/43.4	39.4/45.4	48.3/56.5	51.3/59.5	51.3/59.5
Fan	Static Pressure(Standard/Max)	Pa	20/200	20/200	20/200	20/200	20/200	20/200	20/200	20/180	20/180	20/180	20/180	
		Air flow (H/M/L)	m <sup>3</sup> /h	515/440/390	545/470/390	545/470/390	570/495/420	700/625/550	915/765/640	1275/1050/875	1275/1050/875	1450/1200/1000	2000/1700/1400	2150/1750/1400
Sound level	Sound pressure level(H/M/L)	dB(A)	29/27/25	30/28/25	30/28/25	31/29/27	32/30/28	33/31/29	34/31/29	35/33/30	36/33/30	38/35/32	40/36/32	42/38/34
		Sound power level(H/M/L)	dB(A)	41/39/37	42/40/37	42/40/37	43/41/39	44/42/40	45/43/41	46/43/41	47/45/42	48/45/42	50/47/44	52/48/44
Piping	Refrigerant liquid pipe	mm	6.35	6.35	6.35	6.35	6.35	6.35	9.52	9.52	9.52	9.52	9.52	
		Refrigerant gas pipe	mm	9.52	9.52	9.52	12.7	12.7	12.7	15.88	15.88	15.88	15.88	15.88
Drain pump	O-optional S-standard, N-not	/	S	S	S	S	S	S	S	S	S	S	S	
		/	YR-E17A	YR-E17A	YR-E17A	YR-E17A	YR-E17A	YR-E17A	YR-E17A	YR-E17A	YR-E17A	YR-E17A	YR-E17A	YR-E17A
Controller	Wired(Optional)	/	YR-E16B	YR-E16B	YR-E16B	YR-E16B	YR-E16B	YR-E16B	YR-E16B	YR-E16B	YR-E16B	YR-E16B	YR-E16B	
		/	HW-BA116ABK	HW-BA116ABK	HW-BA116ABK	HW-BA116ABK	HW-BA116ABK	HW-BA116ABK	HW-BA116ABK	HW-BA116ABK	HW-BA116ABK	HW-BA116ABK	HW-BA116ABK	
	Infrared(Optional)	/	HW-BA101ABT	HW-BA101ABT	HW-BA101ABT	HW-BA101ABT	HW-BA101ABT	HW-BA101ABT	HW-BA101ABT	HW-BA101ABT	HW-BA101ABT	HW-BA101ABT	HW-BA101ABT	
		/	YR-HRS01	YR-HRS01	YR-HRS01	YR-HRS01	YR-HRS01	YR-HRS01	YR-HRS01	YR-HRS01	YR-HRS01	YR-HRS01	YR-HRS01	



# Compact Air DUCT



DC fan motor



Standard with anti-bacterial filter



1100mm width design, suitable for hallway installation



Large airflow increased by 20%

# (50/120)



HW-BA116ABK YR-E17A HW-BA101ABT YR-E16B YR-HRS01  
\*1. HW-BA116ABK, YR-E17A and HW-BA101ABT have built-in infrared signal receiver. YR-E16B no such function.

## Compact Air DUCT (50/120)

Model/Indoor unit			AD302MJERN	AD382MJERN	AD482MJERN
Capacity	Cooling	kBtu/h	30.7	38.2	47.8
		kW	9.0	11.2	14.0
	Heating	Btu/h	34.1	44.3	55.6
		kW	10.0	13.0	16.3
Electrical Parameters	Power supply	Ph/V/Hz	1/220-240/50/60	1/220-240/50/60	1/220-240/50/60
	Air Flow(H/M/L)	m <sup>3</sup> /h	2050/1500/1150	2050/1500/1150	2050/1500/1150
Performance	Sound pressure level (H/M/L)	dB(A)	51/49/46	52/49/47	52/49/47
	Sound power level(H/M/L)	dB(A)	67/65/61	69/65/62	69/65/62
Installation	External dimensions(W/D/H)	mm	1100/700/248	1100/700/248	1100/700/248
	Shipping dimensions(W/D/H)	mm	1301/853/305	1301/853/305	1301/853/305
	Net/Shipping weight	kg	35/58	41/44	41/44
	Refrigerant liquid pipe	mm	9.52	9.52	9.52
	Refrigerant gas pipe	mm	15.88	15.88	15.88
Controller	Static Pressure(Standard/Max.)	Pa	50/120	50/120	50/120
	Wire(Optional)	/	YR-E17A	YR-E17A	YR-E17A
		/	YR-E16B	YR-E16B	YR-E16B
		/	HW-BA116ABK	HW-BA116ABK	HW-BA116ABK
	Infrared(Optional)	/	HW-BA101ABT	HW-BA101ABT	HW-BA101ABT
		/	YR-HRS01	YR-HRS01	YR-HRS01



High ESP  
**DUCT**

28kW

Max. capacity 28kW

250 Pa

Max. ESP 250Pa

50Hz

All module can realize 50Hz



AC fan motor

(100/250Pa)



YR-E17A

High ESP  
**DUCT** (100/250Pa)

Model/Indoor unit			AD722MTERAB	AD962MTERAB
Capacity	Model capacity	HP	8	10
	Cooling	kBtu/h	77.1	95.5
		kW	22.6	28.0
	Heating	kBtu/h	86	107.5
kW		25.2	31.5	
Electrical Parameters	Power supply	Ph/V/Hz	1/220-240/50	1/220-240/50
	Net Product	mm	1333/748/495	1333/748/495
Dimensions (W/D/H)	Shipping Product	mm	1558/896/668	1558/896/668
	Product Net/Shipping	kg	87/109	87/109
Weight	Static Pressure(Standard/Max)	Pa	100/250	100/250
	Indoor air flow(S/H/M/L)	m <sup>3</sup> /h	4200/3750/3330/2800	4200/3750/3330/2800
Sound level	Sound pressure level (S/H/M/L)	dB(A)	54/51/49/47	54/51/49/47
	Sound power level (S/H/M/L)	dB(A)	68/65/63/61	68/65/63/61
	Refrigerant liquid pipe	mm	12.7	12.7
Piping	Refrigerant gas pipe	mm	22.22	22.22
	Drain Pump	O=optional, S=standard, N=not	N	N
Controller	Wired(Optional)	/	YR-E17A	YR-E17A



# High ESP DUCT



DC fan motor

28kW

Max. capacity 28kw

300Pa

Max. ESP 250Pa

50/60Hz

All module can realize 50/60Hz

# (0/300Pa)



YR-E17A

YR-HQS01

## High ESP DUCT (0/300Pa)



Model/Indoor unit			AD722MTERAD	AD962MTERAD
Capacity	Model capacity	HP	8	10
	Cooling	kBtu/h	77.1	95.5
	Heating	kW	22.6	28.0
Electrical Parameters	Power supply	PhV/Hz	1/220-240/50/60	1/220-240/50/60
	Net Product	mm	1335/748/495	1335/748/495
Dimensions (W/D/H)	Shipping Product	mm	1558/896/668	1558/896/668
	Product Net/Shipping	kg	87/109	87/109
Weight	Static Pressure (Standard/Max)	Pa	100/300	100/300
	Air flow (S/H/M/L)	m <sup>3</sup> /h	4000/3600/3200/2700	4500/4100/3700/3300
Sound level	Sound pressure level(S/H/M/L)	dB(A)	53/50/48/46	54/51/49/47
	Sound power level(S/H/M/L)	dB(A)	67/64/62/60	68/65/63/61
Piping	Refrigerant liquid pipe	mm	12.7	12.7
	Refrigerant gas pipe	mm	22.22	22.22
Drain Pump	O-optional S-standard, N-not	/	22.22	22.22
	Wired(Optional)	/	YR-E17A	YR-E17A
Controller	Infrared(Optional)	/	YR-HQS01	YR-HQS01

# BUILT-IN FLOOR STANDING



Require very little installation space only 200mm



High efficiency filter fitted as standard



Good solution for installation beneath a window



All models can operate 50/60Hz



HW-BA116ABK

YR-E17A

HW-BA101ABT

YR-E16B

YR-HRS01

## BUILT-IN FLOOR STANDING

Model/Indoor unit		AE072MLERA	AE092MLERA	AE122MLERA	AE162MLERA	AE182MLERA	AE242MLERA
Capacity	Cooling	kBtu/h 7.5	9.5	12.3	15.3	19.1	24.2
		kW 2.2	2.8	3.6	4.5	5.6	7.1
Heating		Btu/h 8.5	10.9	13.6	17.1	21.5	27.3
		kW 2.5	3.2	4	5	6.3	8
Electrical Parameters	Power supply	PhV/Hz	1/220-230/50/60	1/220-230/50/60	1/220-230/50/60	1/220-230/50/60	1/220-230/50/60
	Air flow (H)	m <sup>3</sup> /h	750/650/550	750/650/550	950/830/720	950/830/720	950/830/720
Performance	Sound pressure level(H/M/L)	dBA(A)	38/35/33	38/35/33	40/37/35	42/39/36	42/39/36
	Sound power level(H/M/L)	dBA(A)	51/48/46	51/48/46	53/50/48	55/52/49	55/52/49
Installation	External dimensions(W/D/H)	mm	1116/221/624	1116/221/624	1116/221/624	1116/221/624	1116/221/624
	Shipping dimensions(W/D/H)	mm	1425/315/685	1425/315/685	1425/315/685	1425/315/685	1425/315/685
Net/Shipping weight		kg	29/37	29/37	31/39	31/39	31/39
	Refrigerant liquid pipe	mm	6.35	6.35	6.35	6.35	6.35
Refrigerant gas pipe		mm	9.52	9.52	12.7	12.7	15.88
	Static Pressure	Fa	0/30	0/30	0/30	0/30	0/30
Controller		/	HW-BA101ABT	HW-BA101ABT	HW-BA101ABT	HW-BA101ABT	HW-BA101ABT
		/	YR-E16B	YR-E16B	YR-E16B	YR-E16B	YR-E16B
Wired(Optional)		/	HW-BA116ABK	HW-BA116ABK	HW-BA116ABK	HW-BA116ABK	HW-BA116ABK
		/	YR-E17A	YR-E17A	YR-E17A	YR-E17A	YR-E17A
Infrared(Optional)		/	YR-HRS01	YR-HRS01	YR-HRS01	YR-HRS01	YR-HRS01

# Console



DC fan motor



Space saving



Air discharge through top and bottom



Quiet operation



YR-E17A YR-HRS01

## Console

Model/Indoor unit			AF052MBERA	AF072MBERA	AF092MBERA	AF122MBERA	AF162MBERA	AF182MBERA
Capacity	Cooling	kBtu/h	5.1	7.5	9.5	12.3	15.3	17
		kW	1.5	2.2	2.8	3.6	4.5	5
	Heating	Btu/h	5.8	8.5	10.9	13.6	17	18.5
		kW	1.7	2.6	3.2	4	5	5.5
Electrical Parameters	Power supply	PhV/Hz	1/220-230/50/60	1/220-230/50/60	1/220-230/50/60	1/220-230/50/60	1/220-230/50/60	1/220-230/50/60
Performance	Air flow (l/s)	m <sup>3</sup> /h	540/450/390/310/270	540/460/390/310/270	540/460/390/310/270	580/500/420/350/270	620/540/460/390/270	620/540/460/390/270
	Sound pressure level(M/M/L)	dB(A)	45/42/38/33/30	45/42/38/33/30	45/42/38/33/30	47/44/40/36/30	48/45/42/38/30	48/45/42/38/30
Installation	External dimensions(W/D/H)	mm	700/210/600	700/210/600	700/210/600	700/210/600	700/210/600	700/210/600
	Shipping dimensions(W/D/H)	mm	783/303/695	783/303/695	783/303/695	783/303/695	783/303/695	783/303/695
	Net/Shipping weight	kg	15.2/18.7	15.2/18.7	15.2/18.7	15.2/18.7	15.2/18.7	15.2/18.7
	Refrigerant liquid pipe	mm	6.35	6.35	6.35	6.35	6.35	6.35
	Refrigerant gas pipe	mm	12.7	12.7	12.7	12.7	12.7	12.7
Controller	Wired(Optional)	/	YR-E17A	YR-E17A	YR-E17A	YR-E17A	YR-E17A	YR-E17A
	Infrared(Optional)	/	YR-HRS01	YR-HRS01	YR-HRS01	YR-HRS01	YR-HRS01	YR-HRS01

# N High WALL



DC fan motor



Built in EEV, easy to installation



Stylish design & LED display



Comfortable Sleep



Model/Indoor unit		AS052MNERAB AS052MNERAB AS052MNFIERAC	AS072MNERAB AS072MNERAB AS072MNFIERAC	AS092MNERAB AS092MNERAB AS092MNFIERAC	AS122MNERAB AS122MNERAB AS122MNFIERAC	AS162MNERA AS162MNERA AS162MNFIERAC	AS182MNERA AS182MNERA AS182MNFIERAC	AS242MNERA AS242MNERA AS242MNFIERAC	AS282MNERA AS282MNERA AS282MNFIERAC	AS302MNERA AS302MNERA AS302MNFIERAC	
Capacity	Cooling	kBtu/h	5.1	7.5	9.5	12.3	15.3	19.1	24.2	27.3	30.7
		kW	1.5	2.2	2.8	3.6	4.5	5.6	7.1	8	9
	Heating	Btu/h	5.8	8.5	10.9	13.6	17.1	21.5	27.3	30.7	34.1
		kW	1.7	2.5	3.2	4	5	6.3	8	9	10
Electrical Parameters	Power supply	Ph-V/Hz 1/220-240/50/60		1/220-240/50/60		1/220-240/50/60		1/220-240/50/60		1/220-240/50/60	
	Air flow (H)	m <sup>3</sup> /h	500/430/370	550/480/420	600/530/470	650/560/500	800/720/650	920/800/720	1010/920/800	1500/1400/1300	1600/1500/1400
Performance	Sound pressure level@1M	cB(A)	33/31/29	35/31/29	36/31/29	37/33/29	39/36/34	40/39/35	44/40/36	48/43/40	49/44/41
	Sound power level@1M	cB(A)	49/46/41	50/47/42	52/48/44	54/51/50	56/53/51	57/54/52	58/56/54	60/57/53	61/58/54
	External dimensions(WxD*H)	mm	855/208/290	855/208/290	855/208/290	855/208/290	1115/243/336	1115/243/336	1115/243/336	1316/270/365	1316/270/365
Installation	Shipping dimensions(WxD*H)	mm	954/279/355 *1054/279/355	954/279/355 *1054/279/355	954/279/355 *1054/279/355	954/279/355 *1054/279/355	1206/342/418 *1306/342/418	1206/342/418 *1306/342/418	1206/342/418 *1306/342/418	1403/384/463 *1503/384/463	1403/384/463 *1503/384/463
	Net/Shipping weight	kg	9.9/12 *9.9/14.2	9.9/12 *9.9/14.2	9.9/12 *9.9/14.2	9.9/12 *9.9/14.2	15.8/18.9 *15.8/21.2	15.8/18.9 *15.8/21.2	15.8/18.9 *15.8/21.2	21.8/26.3 *21.8/27.2	21.8/26.3 *21.8/27.2
	Refrigerant liquid pipe	mm	6.35	6.35	6.35	6.35	6.35	6.35	9.52	9.52	9.52
	Refrigerant gas pipe	mm	9.52	9.52	9.52	12.7	12.7	12.7	15.88	15.88	15.88
	Controller	Wired(Optional)	/	HW-BA101ABT YR-E16B	HW-BA101ABT YR-E16B	HW-BA101ABT YR-E16B	HW-BA101ABT YR-E16B	HW-BA101ABT YR-E16B	HW-BA101ABT YR-E16B	HW-BA101ABT YR-E16B	HW-BA101ABT YR-E16B
	Infrared(Optional)	/	HW-BA116ABK YR-E17A	HW-BA116ABK YR-E17A	HW-BA116ABK YR-E17A	HW-BA116ABK YR-E17A	HW-BA116ABK YR-E17A	HW-BA116ABK YR-E17A	HW-BA116ABK YR-E17A	HW-BA116ABK YR-E17A	

\*Note: Please choose AV\*\*\*MNFIERAC series for quiet required environment.  
The electronic expansion valve of AV\*\*\*MNFIERAC series is outside.  
\*For AS\*\*\*MNFIERAC

# N High WALL



# MRV INDOOR Ventilation

## 165 VENTILATION

Fresh Air Duct

HRV



## Ventilation

### Introduction of fresh air, indoor air supply more comfortable

Aqua fresh air duct can heat or cool the outdoor fresh air to close to the indoor temperature and transport fresh air to the room. In spring and autumn, fresh air can be filtered without passing through the coil, directly sent into the room to save the energy.

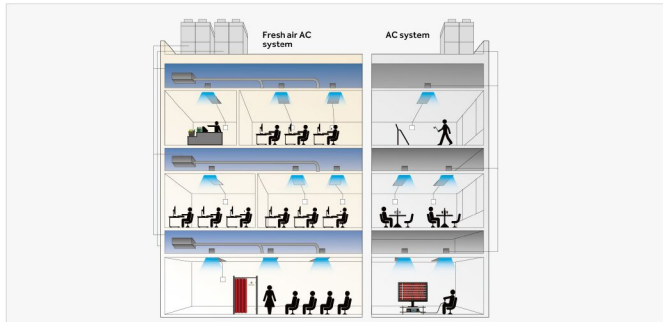

Adopt R410a environment-friendly refrigerant, efficient use of DC frequency conversion technology, more energy saving



The fresh air duct can be mixed with the MRV indoor units to achieve unified management.



Adopt high efficiency brushless DC fan motor, the rotating speed can be adjusted flexibly according to the actual static pressure to ensure the stable output of air volume, greatly reduce low operating noise.



The built-in float switch can monitor the condensate status of the water receiving tray in real time to avoid accidents. Water leakage and other hidden dangers caused by poor drainage. (for AD72/962MTERAF)

# Fresh Air DUCT

100-350

Variable static pressure  
100-350Pa setting



DC fan motor



Fresh air

50/60Hz

All module can realize  
50/60Hz



YR-E17A YR-HQ501

Fresh Air  
DUCT

Model/Indoor unit		AD482M/JERAF	AD722M/TERAF	AD962M/TERAF	
Capacity	Cooling	kBtu/h	47.7	77.1	95.5
		kW	14	22.6	28
	Heating	Btu/h	34.1	68.2	83.5
		kW	10	20	24.5
Electrical Parameters	Power supply	PhV/Hz	1/220-240/50/60	1/220-240/50/60	1/220-240/50/60
	Air flow (l/s)	m <sup>3</sup> /h	1900/1600/1460/1200	2800/2300/1800/1500	3200/2800/2400/2000
Performance	Sound pressure level(M/M/L)	dB(A)	48/46/44/42	48/46/44/42	49/47/45/42
	Sound power level(H/M/L)	dB(A)	61/59/57/55	61/59/57/55	62/60/58/55
	External dimensions(W/D/H)	mm	1500/700/248	1333/750/497	1333/750/497
Shipping dimensions(W/D/H)		mm	1698/857/305	1558/896/668	1558/896/668
Installation	Net/Shipping weight	kg	45.4/52.6	88/110	88/110
	Refrigerant liquid pipe	mm	9.52	12.7	12.7
	Refrigerant gas pipe	mm	15.88	22.22	22.22
	Static Pressure(Standard/Max.)	Pa	100/200	100/350	100/350
	Controller	Wired (Optional)	/	YR-E17A	YR-E17A
/			YR-HQ501	YR-HQ501	YR-HQ501

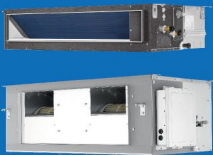

# HRV



Be controlled with other indoor units together



Heat recovery media element



Efficient heat recovery air processing



Max. air flow 1000m³/h



W9301



Model/Indoor unit			ERV0150ANW	ERV0260ANW	ERV0500ANW	ERV0800ANW	ERV1000ANW
Electrical	Power supply	PhV/Hz	1/220-240/50/60	1/220-240/50/60	1/220-240/50/60	1/220-240/50/60	1/220-240/50/60
	Rated power input	W	135	165	280	360	420
	Rated current	A	0.65	0.79	1.34	1.72	2.01
Enthalpy exchange effectiveness	Cooling condition		58%	57%	61%	68%	61%
	Heating condition		65%	65%	68%	72%	65%
Performance	Air flow (H/M/L)	m³/h	150/110/70	250/200/160	500/450/375	800/680/600	1000/810/730
	Sound pressure level (H/M/L)	dB(A)	38/35/30	40/38/35	45/42/40	48/46/43	50/48/45
	Sound power level (H/L)	dB(A)	48/45/40	50/48/45	55/52/50	58/58/53	60/58/55
Installation	External dimensions(W/D/H)	mm	750/530/240	750/530/270	1000/710/270	1200/940/324	1250/935/350
	Shipping dimensions(W/D/H)	mm	955/575/305	955/575/335	1205/755/335	1405/985/389	1455/980/415
Controller	Net weight/Shipping weight	kg	26/28	30/32	40/42	55/59	56/60
	Static Pressure	Pa	80	80	100	100	100
Controller	Wired (Standard)	/	W9301	W9301	W9301	W9301	W9301



# Dimensions

## 4-Way Cassette

AB052MCERA AB072MCERA AB092MCERA AB122MCERA AB162MCERA AB182MCERA(C)

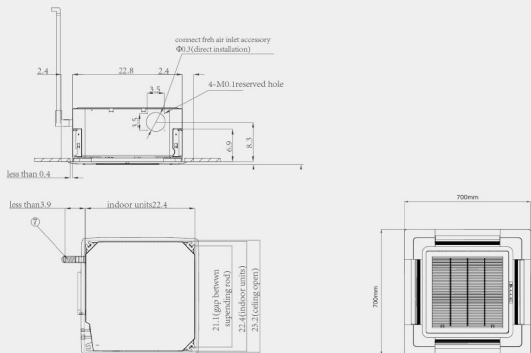

## 4-Way Cassette

AB242MNERA AB282MNERA

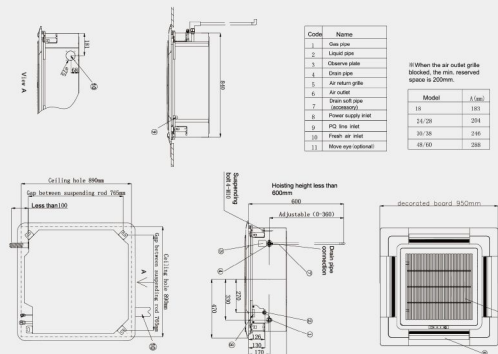

Code	Name	Model	W (mm)	H (mm)
1	Ceiling pipe	18	183	
2	Lead-off pipe	14/28	204	
3	Obstacle plate	30/30	246	
4	Chair pipe	60/100	288	
5	Air return grille			
6	Adjuster			
7	Down wall pipe (Ø200/Ø100)			
8	Power supply inlet			
9	FR line inlet			
10	Fresh air inlet			
11	Make eye (optional)			

⑩ Within the air outlet grille blocked, the min. reserved space is 200mm.

## 4-Way Cassette

AB182MNERA

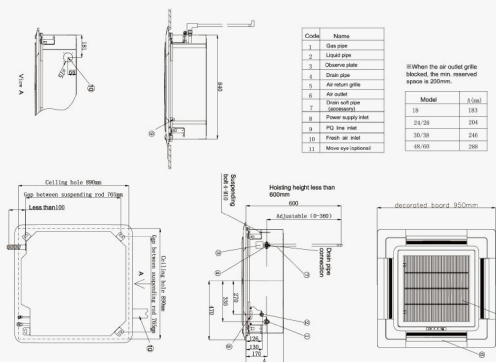

Code	Name	Model	W (mm)	H (mm)
1	Ceiling pipe	18	183	
2	Lead-off pipe	14/28	204	
3	Obstacle plate	30/30	246	
4	Chair pipe	60/100	288	
5	Air return grille			
6	Adjuster			
7	Down wall pipe (Ø200/Ø100)			
8	Power supply inlet			
9	FR line inlet			
10	Fresh air inlet			
11	Make eye (optional)			

⑩ Within the air outlet grille blocked, the min. reserved space is 200mm.

## 4-Way Cassette

AB302MNERA AB382MNERA

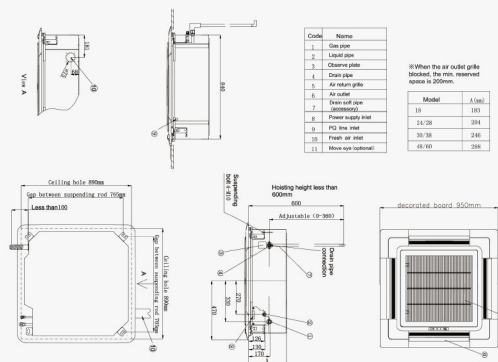

Code	Name	Model	W (mm)	H (mm)
1	Ceiling pipe	18	183	
2	Lead-off pipe	14/28	204	
3	Obstacle plate	30/30	246	
4	Chair pipe	60/100	288	
5	Air return grille			
6	Adjuster			
7	Down wall pipe (Ø200/Ø100)			
8	Power supply inlet			
9	FR line inlet			
10	Fresh air inlet			
11	Make eye (optional)			

⑩ Within the air outlet grille blocked, the min. reserved space is 200mm.





# Dimensions

High ESP Duct (100/200Pa)  
Medium ESP Duct (150/100Pa)  
High ESP Duct (200/200Pa)

AD382MJERA(H) AD482MJERA(H) AD542MJERA(H)  
AD382MJERA AD482MJERA AD542MJERA  
AD382MJERAD AD482MJERAD AD542MJERAD

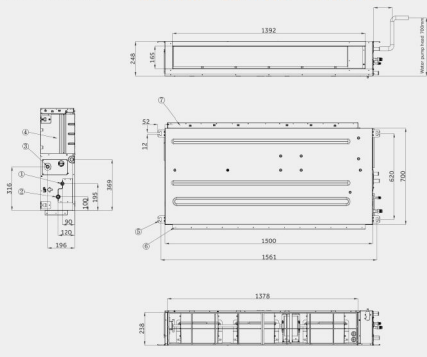

No.	Name
1	Liquid pipe
2	Gas pipe
3	Drain pipe
4	Electrical box
5	Hanging foot
6	Air outlet
7	Air return
8	Fresh-air

Built-in Floor Standing

AE072MLERA AE092MLERA AE122MLERA AE162MLERA AE182MLERA AE242MLERA

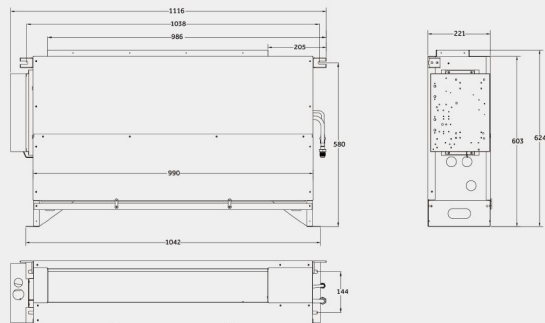

High ESP Duct  
(100/250Pa)

AD722MTERAB AD962MTERAB AD722MTERAD AD962MTERAD

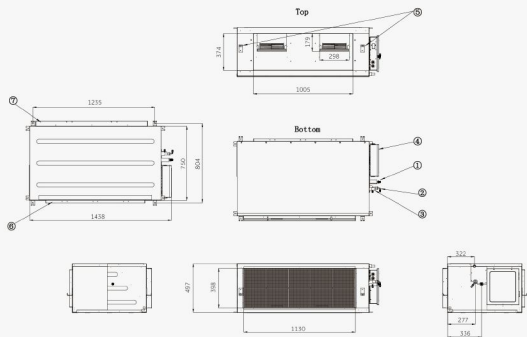

No.	Name
1	Liquid pipe
2	Gas pipe
3	Drain pipe
4	Electrical box
5	Angle iron for hanging
6	Air outlet
7	Air return

Console

AF052MBERA AF072MBERA AF092MBERA AF122MBERA AF162MBERA AF182MBERA

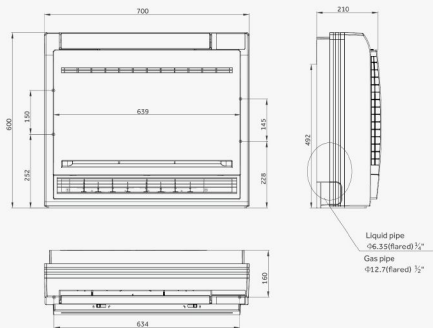

# Dimensions

## N High Wall

AS052MNERAB AS072MNERAB AS092MNERAB AS122MNERAB  
AS052MFERAB AS072MFERAB AS092MFERAB AS122MFERAB

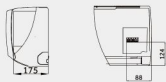
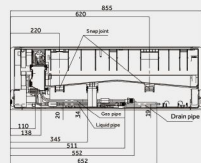
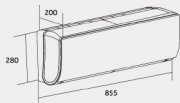

## N High Wall

AS282MNERA AS302MNERA

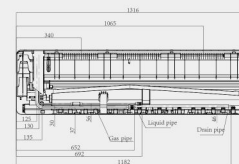
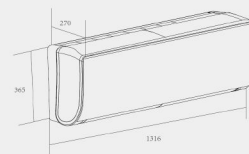

## N High Wall

AS162MNERA AS182MNERA AS242MNERA  
AS162MFERA AS182MFERA AS242MFERA

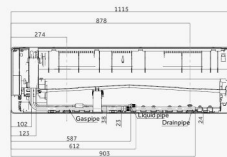
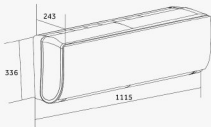

## Fresh Air Duct

AD482MJERF

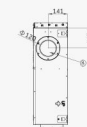
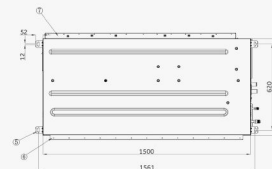

No.	Notes
1	Liquid pipe
2	Gas pipe
3	Drain pipe
4	Electrical box
5	Hanging foot
6	Air outlet
7	Air return
8	Fresh air

# Dimensions

## Fresh Air Duct

AD722MTERAF AD962MTERAF

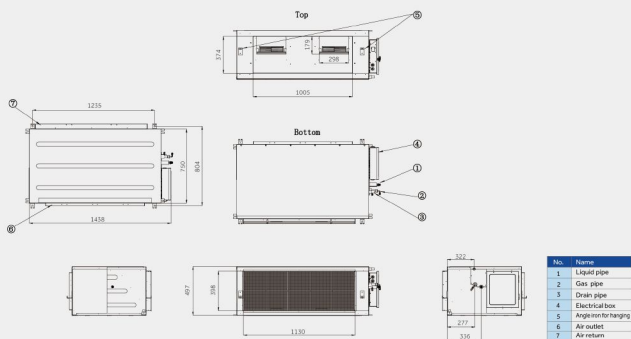

## HRV

ERV0150ANW ERV0260ANW ERV0500ANW ERV0800ANW ERV1000ANW

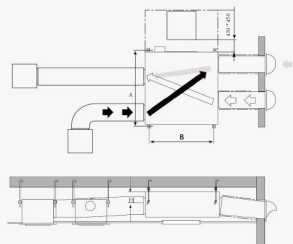

Model	L	B	H
ERV0150ANW	530	750	240
ERV0260ANW	530	750	270
ERV0500ANW	690	1000	256
ERV0800ANW	920	1200	324
ERV1000ANW	915	1250	350



## CONTROL SYSTEM

- 187** Individual Controller
- 189** Centralized Controller
- 193** BMS Solution
- 199** Multi Tenant Solution
- 200** Service Tool

## Individual Controller

The individual control system has a variety of wired and wireless controllers which enable you easy and intelligent control of your air conditions; you can choose the one which best suits for your air conditioning management.

### INDIVIDUAL CONTROLLER

#### YR-HQS01/YL-HQS01

- On/Off, Operation mode, Fan speed, Temperature setting, Swing
  - Turbo and quiet
  - Individual lower control for round flow 4-way cassette and mini 4-way cassette
  - Clock & timer
  - Health function
  - Self-clean
  - Backlight
  - Convenient to operate most functions through one button
- Note: YR-HQS01 for heat pump system; YL-HQS01 for cooling only system



#### YR-HRS01

- On/Off, Operation mode, Fan speed, Temperature setting, Swing
- Turbo and quiet
- Individual lower control for round flow 4-way cassette and mini 4-way cassette
- Self-clean
- Timer
- Health function
- Backlight



## INDIVIDUAL CONTROLLER

### YR-E17A

- On/Off, Mode, Fan speed, Temperature setting, Swing
- Individual & Group control (Max. 16 indoor units)
- Simple and Smart design, 86\*86\*13.05mm
- Touch button with back light
- Timer / Clock
- Individual flap control for round wall cassette and compact cassette
- Built-in infrared signal receiver for duct units
- Self-cleaning function
- Built-in humidity sensor and humidity display



### HW-BA116ABK

- Alternating current
- Basic function: on/off, mode, fan speed, temperature
- Individual & group control (max. 16 indoor units)
- Simple and smart design, 86\*86\*14.80mm
- Could receive wireless controller signal



### HW-BA101ABT

- Individual & group control (max. 16 indoor units controllable)
- Compact design 86\*86mm
- Touch screen
- Black and tempered glass body with highlight LED icon display
- Basic function: on/off, mode, swing, dry, auto
- Built-in infrared signal receiver for infrared remote control
- Built-in buzzer



### YR-E16B

- Colorful screen
- On/off, mode, fan speed, temperature setting, swing
- Individual & group control (max. 16 indoor units)
- Fahrenheit/celsius selectable; sensitivity  $\pm 0.5^\circ\text{C}$  ( $\pm 1^\circ\text{F}$ )
- Weekly timer
- Individual lower control for MINI 4-way cassette and round flow 4-way cassette
- Static pressure setting



### RE-02

- Infrared signal receiver
- Realize the remote control of duct type indoor unit
- Model selection depends on the duct indoor unit



### Central Control WIFI Module (HI-WA164DBI)

- Individual/Central remote control by APP
- Max. 64 IDUs controllable for single wifi module (Max. 256 for combinations)
- Remote monitoring and control: on/off, temp, operation mode, fan speeds
- Weekly scheduling
- Error alarm and error history
- Convenient management authority sharing without repeating to pair with units
- Connecting to 5-inch central controller (HC-SA164DBT); (MRV5 and HA-MA164AD gateway can connect directly.)



# Centralized Controller

The centralized control system offers you a smart and convenient experience while managing your air conditioner individually or by groups or by zones, a variety of controllers can be used to perfect your air conditioning management.



## CENTRALIZED CONTROLLER

### HC-SA164DBT

- Individual control, central control (max. 64 indoor units)
- 5-inch TFT LCD touch screen with back light
- Weekly timer
- Indoor units' information editable
- Historical error
- MRV 5 system and upgraded MRV SIII(8/10/12HP) outdoor units can connect directly
- Other MRV system requires HA-MA164AD



## CENTRALIZED CONTROLLER

Monitoring up to 64 indoor unit could control HRV and monitoring the state of all IDU display Fault IDU number

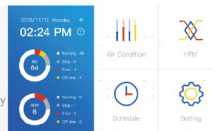

Set schedule for unit, group, all time control could be add, change, delete, unit control, group control, all ON/OFF

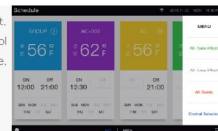

Turn ON/OFF the DST, DST schedule time setting, DST compensation setting

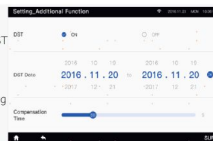

Display the detailed information check the name, number, temperature, running time and fault code



Interface display mode choice: list or icon All on, all off, control all, control select



Setting password according to user demand

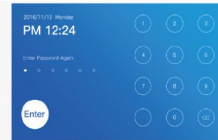

## HC-SA164DBT System

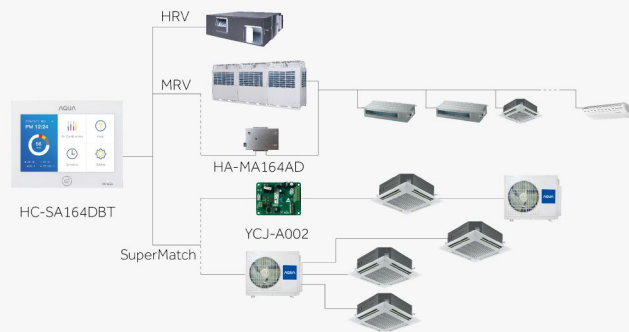

## CENTRALIZED CONTROLLER

### YCZ-A004

- Individual control, group control & central control (Max. 256 indoor units)
- Max. 800 MRV indoor units and Max. 128 LCAC IDUs connectable for one controller totally 928 IDUs connectable
- Floor plan layout view
- Web access and email alarm
- Weekly schedule and special day setting
- Integrate 3rd party devices like fire alarm, lighting with AQUA indoor units
- All MRV system requires the new gateway HA-MA164AD (one system requires one gateway)
- LCAC products requires PCB adapter YCJ-A002 (One IDU requires one YCJ-A002)
- Total electricity consumption display
- Data curve
- Electricity consumption distribution for tenant billing
- Multi language



### YCZ-A004 System

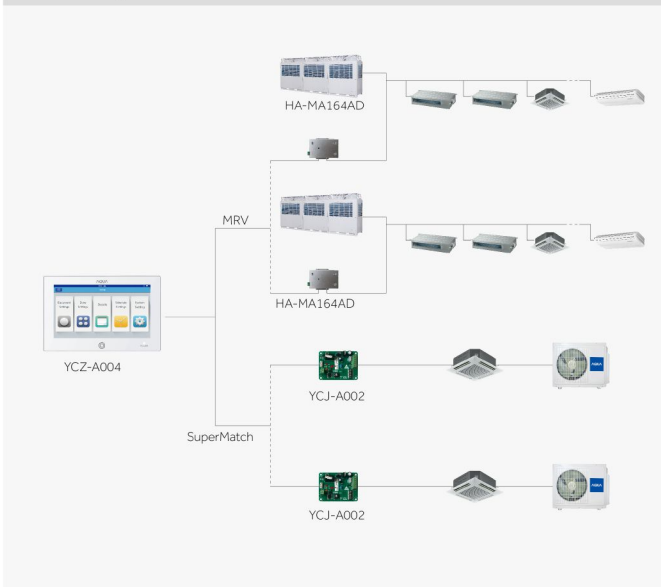

## CENTRALIZED CONTROLLER

### HC-LA1CDBT

- 12.5-inch TFT LCD touch screen
- Max. 800 MRV indoor units and Max. 128 LCAC IDUs connectable for one controller totally 928 IDUs connectable
- Floor plan layout view
- Web access and email alarm
- Weekly schedule and special day setting
- Integrate 3rd party devices like fire alarm, lighting with AQUA indoor units
- All MRV system requires the new gateway HA-MA164AD (one system requires one gateway)
- LCAC products requires PCB adapter YCJ-A002 (One IDU requires one YCJ-A002)
- Total electricity consumption display
- Data curve
- Electricity consumption distribution for tenant billing
- Multi language



### HC-LA1CDBT System

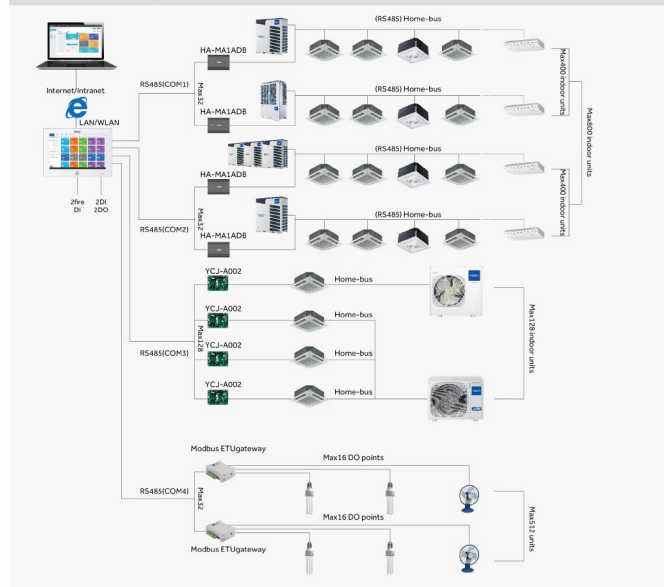

# BMS Solution

The building management modules could perfectly integrate air conditioners into the building management system, providing an excellent solution for large commercial areas.

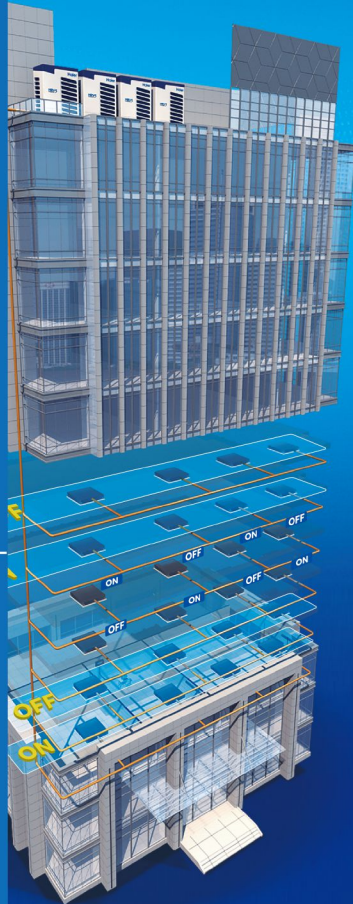

AQUA BMS monitor system is used to meet the demands of remote monitoring and controlling the AC systems, 3rd party BMS or BAS interface and electricity distribution management i.g the tenant billing.

## BMS MONITOR

### HCM-01A

- Local control version: convert USB to RS-485
- Max. 400 indoor units can be controlled
- Modbus rtu interface
- Brand new interface design
- Win 7 32bits/64bits, Win 8 Pro, Win 10 Pro
- Max.32 systems connectable
- MRV 5system and upgraded MRV SIII(8/10/12HP) outdoor units can directly connect with HCM-01A
- Other MRV system outdoor units require HA-MA164AD
- Electricity charge report (must use IGU02)



### HCM-01A System

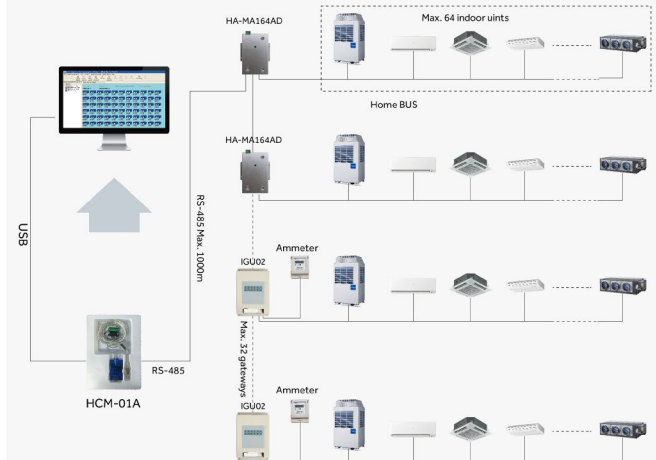

\*Each outdoor system requires one HA-MA164AD; For power consumption function, users should connect IGU02 and Ammeter.

## BMS BMS MONITOR

### HCM-03A

- Remote monitoring version; third party interface: BACnet ip/ modbus ip
- Max. 1500 indoor units can be controlled
- Max. 4 groups, each group can connect 20 systems
- MRV 5 system and upgraded MRV SIII(8/10/12HP) outdoor units can directly connect with HCM-03A
- Other MRV system outdoor units require HA-MA164AD
- Operation status setting & monitoring.
- Schedule setting
- Multi user management with different authorized levels
- Operation and error history log
- Electricity charge report (must use IGU02)



### HCM-03A System

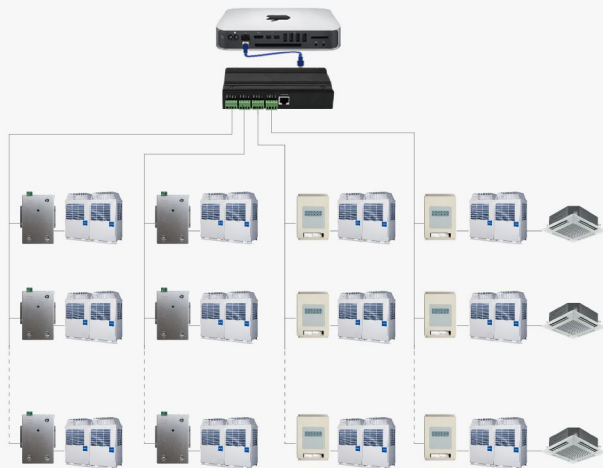

## BMS BMS MONITOR

### HCM-06

- Remote monitoring version
- Third party interface: BACnet ip
- Max. 250 indoor units can be controlled for HCM-06.
- Max. 32 systems for HCM-06. Each system requires one IGU02/HA-MA164AD
- Operation status setting & monitoring.
- Schedule setting
- Multi user management with different authorized levels
- Electricity charge report (must use IGU02)
- Operation and error history log
- Cooperated technology with honeywell



### HCM-06 System



# BMS Interface

The adapters offer you an easy and convenient way to integrate air conditioners into various building management system, perfect for large commercial projects.

AQUA BMS interface devices are used to connect the 3rd party BMS or BAS system, including the modbus interface, BACnet interface and lonworks interface etc.



## BMS INTERFACE

### HA-MA164AD

- Protocol adapter, convert homebus to RS-485
- Gateway: modbus rtu
- Max. 64 indoor units can be connected with one HA-MA164AD
- MRV System and upgraded MRV SIII(8/10/12HP) outdoor units can directly connect with central controller HC-SA164AD and YCZ-A004 or BMS monitor: HCM-01A and HCM-03A
- Other MRV system outdoor units require HA-MA164AD



### HA-MA1ADB

- Interface: Modbus
- Match with 12.5-inch webservice central controller HC-LA1CDBT
- Max. 128 indoor units connectable
- Digital tube display Indoor quantity, gateway address, time and date
- Electricity data collection, calculation, distribution and storage



### IGU02

- Protocol adapter, convert homebus to modbus
- Electricity data collection, calculation, allocation and storage
- Match with BMS (HCM-01A,03A,05,05A), each system requires one IGU02
- Max.40 indoor units can be connected with one IGU02



### IGU07

- Protocol adapter, convert modbus rtu to lonworks
- Each system requires one IGU07+ HA-MA164AD
- Max. 32 indoor units can be connected in one system
- External 24V DC power supply is needed



## LonWorks System

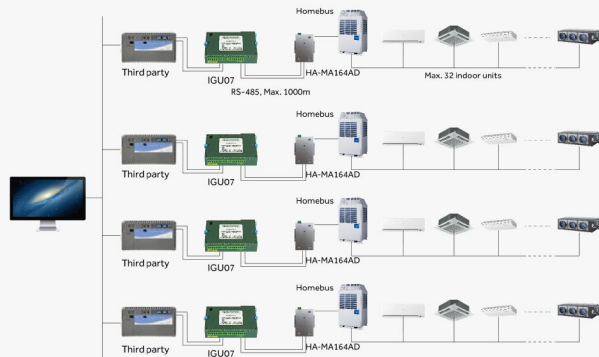

## BMS INTERFACE

### HCM-04

- BACnet gateway, convert modbus rtu to BACnet ip
- Max. 128 indoor units/ 4 systems can be controlled. Max. 32 indoor units for one system
- MRV 5 and upgraded MRV SII (8/10/12HP) can connect directly with HCM-04.
- Other MRV systems require IGU02 or HA-MA164AD
- BTL certificate



### HA-AC-KNX-8 / HA-AC-KNX-16 / HA-AC-KNX-64

- KNX gateway
- Convert modbus to KNX
- Max. 8/ 16/ 64 indoor units can be connected in one system
- MRV 5 and upgraded MRV SII (8/10/12HP) can connect directly
- Other MRV systems require HA-MA164AD



\*For the KNX gateway purchase, please contact the KNX manufacture Intesis directly

## MULTI TENANT SOLUTION

### MTC-001

Application Scenario:

- The multi tenant site using separate circuit breaker for each indoor unit
  - The hotel room using key-tag system which cuts off the power of indoor unit directly
- When it is detected that any connected indoor unit is forcibly cut off, the MTC-001 provides DC power to the indoor PCB to ensure that the indoor unit maintains standby mode: the EEV is turned off and the control signal is blocked to prevent the system from alarming



•Note: If there is power or communication failure in the indoor computer board, MTC-001 cannot be prevented and detected

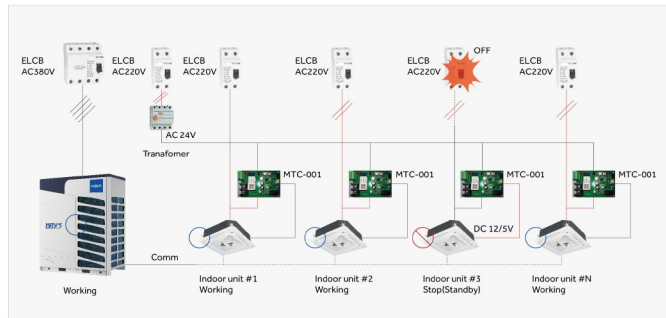

## SERVICE TOOL

### Address setting and checking tool YR-NS

- On/Off, Mode, Fan speed, Temperature setting, Swing
- IDU address checking
- IDU address setting



### AQUA HACs selection software -easy to design and customization

AQUA HACs selection software supports PC & App, which means the reports and information on the phone and computer are synchronous.

With the AQUA MRV selection software, engineers and consultants can easily design, layout and prepare a full MRV system for quotation in a few steps. It selects the right models to meet your building load requirements and calculates the piping schematic automatically or manually, as well as the wiring. It's possible to import dwg or jpg drawings, the selection software guides you within design rules and offers a comprehensive system design report under pdf, word or excel format.

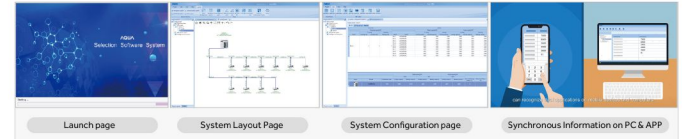

### Service tool TD-03 with monitoring software

Installers can use TD-03 service tool together with monitoring software to realize real-time monitoring the operation data of VRF system through the PC. the running data and parameters can be used to analyze the error for fast troubleshooting, also you can save the data for further analysis.

























## ❁ CONTROLLERS MATCH TABLE FOR MRV INDOOR UNITS

Outlook	Series	Model						
			YR-HRS01	YR-HOS01	HW-B4116ABK	HW-S4101ABT	YR-E17A	YR-E16B
	1-Way Cassette	AB**2MAERA	•	•	•	•	•	•
	2-Way Cassette	AB**2MBERA	•	•	•	•	•	•
	Compact Cassette	AB**2MCERA(M)	•	•				
	Round Way Cassette	AB**2MRERA	•	•				
	4-Way Cassette	AB**2MNERA AB**2MCERA	•	•	•	•	•	•
	Convertible	AC**2MDERA	•	•			•	•
	Slim Duct (0/15/30Pa) (Air Guard)	AD**2MSERA(H)	•		•	•	•	•
	Slim Duct (0/15/30Pa)	AD**2MSERA(D)	•		•	•	•	•
	Slim Duct (0/30Pa)	AD**2MSERA	•		•	•	•	•
	High ESP Duct (20/200Pa) (Air Guard)	AD**2MJERA(H)	•		•	•	•	•
	Medium ESP Duct (50/100 Pa)	AD**2MJERA AD**2MJERAB AD**2MJERAC	•		•	•	•	•
	High ESP Duct (20/200Pa)	AD**2MJERAD	•		•	•	•	•
	High ESP Duct (100-250Pa)	AD**2MGERA						•
	High ESP Duct (0-300Pa)	AD**2MTERAD		•			•	
	High Wall (N platform)	AS**2MFERAB AS**2MVERAC	•	•	•	•	•	•
	High Wall (N platform)	AS**2MFERA AS**2MFERAC	•	•	•	•	•	•
	Console	AF**2MBERA	•	•				
	Built-in Floor Standing	AE**2MLERA	•	•	•	•	•	•
	Fresh Air Duct	AD482MJERF AD722MTERF AD962MTERF			•	•	•	

\* Controllers can match with the indoor unit.

## 🌀 ACCESSORIES

Name	Design	Model	Functions	For what units
Gather pipe		HZG-20A	Refrigerant gathering for MRV II, MRV III-PLUS	2 outdoor units
Gather pipe		HZG-30A	Refrigerant gathering for MRV II, MRV III-PLUS	3 outdoor units
Gather pipe		HZG-20B	Refrigerant gathering for MRV IV, MRV 5	2 outdoor units
Gather pipe		HZG-30B	Refrigerant gathering for MRV IV, MRV 5	3 outdoor units
Gather pipe		HZG-R20A	Refrigerant gathering for MRV II-RC	2 outdoor units
Gather pipe		HZG-R30A	Refrigerant gathering for MRV II-RC	3 outdoor units
Gather pipe		HZG-R20B	Refrigerant gathering for MRV 5-RC	2 outdoor units
Gather pipe		HZG-R30B	Refrigerant gathering for MRV 5-RC	3 outdoor units
Gather pipe		HZG-R40B	Refrigerant gathering for MRV 5-RC	4 outdoor units
Manifold pipe		FQG-B335A	Refrigerant distribution for heat pump MRV	Total indoor units capacity less than 33,500W
Manifold pipe		FQG-B506A	Refrigerant distribution for heat pump MRV	Total indoor units capacity less than 50,600W, but equal or bigger than 33,500W
Manifold pipe		FQG-B730A	Refrigerant distribution for heat pump MRV	Total indoor units capacity less than 73,000W, but equal or bigger than 50,600W
Manifold pipe		FQG-B1350A	Refrigerant distribution for heat pump MRV	Total indoor units capacity less than 135,000W, but equal or bigger than 73,000W
Manifold pipe		FQG-R335A	Refrigerant distribution for heat recovery MRV	Total indoor units capacity less than 33,500W
Manifold pipe		FQG-R506A	Refrigerant distribution for heat recovery MRV	Total indoor units capacity less than 50,600W, but equal or bigger than 33,500W
Manifold pipe		FQG-R730A	Refrigerant distribution for heat recovery MRV	Total indoor units capacity less than 73,000W, but equal or bigger than 50,600W
Manifold pipe		FQG-R1350A	Refrigerant distribution for heat recovery MRV	Total indoor units capacity less than 135,000W, but equal or bigger than 73,000W
Manifold pipe		FQG-R2040A	Refrigerant distribution for heat pump	Total indoor capacity less than 204,000W, but equal or bigger than 135,000W
Manifold pipe		FQG-R2040A	Refrigerant distribution for heat recover	Total indoor capacity less than 204,000W, but equal or bigger than 135,000W
VP box		VP1-112A, VP1-180A VP1-280A	Valve pipe box	MRV III-RC(heat recovery)
VP box		VP4-450A	Valve pipe box	MRV III-RC(heat recovery)
VP box		VP1-112C, VP1-180C VP1-280C	Valve pipe box	MRV 5-RC(heat recovery)
VP box		VP4-450C	Valve pipe box	MRV 5-RC(heat recovery)

# REFERENCE PROJECTS



Subway



Industrial



Offices



Hotel



Education



Hospital



Home & Apartment



Shop & Showroom



# Reference Projects

Country: Vietnam  
Project Name: Broad Ocean Haiphong Factory  
Installation Series: MRV5



Country: Vietnam  
Project Name: Nissan Center  
Installation Series: MRVII-C



Country: Vietnam  
Project Name: Porsche Center  
Installation Series: MRVII-C



Country: Vietnam  
Project Name: Saigon Pearl  
Installation Series: MRV5 & MRV5



# Reference Projects

Country: Algeria  
Project Name: Mobil Art  
Installation Series: MRV-S&MRVIII



Country: Algeria  
Project Name: Hotel-Akbou Bedjaia  
Installation Series: MRVII-C&MRVIII-C



Country: Algeria  
Project Name: AGB Bank  
Installation Series: MRVII-C



Country: Algeria  
Project Name: Mole Fix Office  
Installation Series: MRVII-C



# Reference Projects

Country: Algeria  
Project Name: Ofarco Office  
Installation Series: MRVII-S



Country: Algeria  
Project Name: Tapis Office and Showroom  
Installation Series: MRVII-C

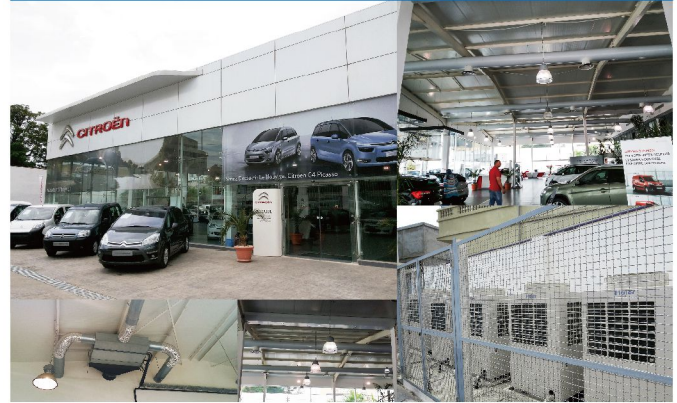

Country: Algeria  
Project Name: Telecom Com Office  
Installation Series: MRVII-C



Country: Algeria  
Project Name: Cabinda Stadium  
Installation Series: MRVII-C



# Reference Projects

Country: **Czech Republic**  
Project Name: **Outlet Arena Moravia**  
Installation Series: **MRV-S + MRV5**



Country: **Czech Republic**  
Project Name: **Pragolaktos**  
Installation Series: **MRV-S + MRV5**



Country: **Czech Republic**  
Project Name: **Geosan Group**  
Installation Series: **MRVIII-C**



Country: **Cyprus**  
Project Name: **Avlogyros**  
Installation Series: **MRVII-C**



# Reference Projects

Country: Czech Republic  
Project Name: DEK Stavebniny  
Installation Series: MRV-S



Country: France  
Project Name: Les Roches Rouges hotel  
Installation Series: MRV IV



Country: Cyprus  
Project Name: Viva Souvenir Shop Aya Napa  
Installation Series: MRVII-C



Country: Hungary  
Project Name: Cordia City Garden Budapest  
Installation Series: MRVII-C



# Reference Projects

Country: Italy  
Project Name: Pantheon Hotel  
Installation Series: MRV III-RC



Country: Italy  
Project Name: Marina Hotel  
Installation Series: MRV IV



Country: Italy  
Project Name: Audi Shop  
Installation Series: MRV 5+MRV S



Country: Italy  
Project Name: Smooth Hotel  
Installation Series: MRV III

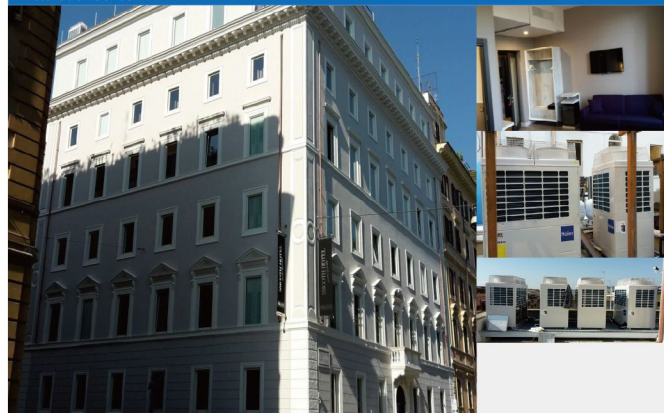

# Reference Projects

Country: Italy  
Project Name: Meininger Hotel  
Installation Series: MRV III C Plus + MRV III -RC



Country: Indonesia  
Project Name: St. Borromeus Hospital  
Installation Series: MRVIII-C



Country: Indonesia  
Project Name: Kosambi Apartement  
Installation Series: MRV IV-C & SINGLE



Country: Israel  
Project Name: Acro Real Estate High-end Residential Project  
Installation Series: MRV SII



# Reference Projects

Country: India  
Project Name: Saveetha Engg. College  
Installation Series: MRV System



Country: India  
Project Name: ITC Factory  
Installation Series: MRV System



Country: India  
Project Name: Pratiksha Hospital  
Installation Series: MRV System



Country: India  
Project Name: Enrise Sayaji Hotels  
Installation Series: MRV System+ Light Commercial



# Reference Projects

Country: India  
Project Name: Sky Mansion  
Installation Series: MRV System



Country: India  
Project Name: Oil & Natural Gas Corporation Ltd  
Installation Series: MRV System



Country: Malta  
Project Name: St. Vincent de Paul Residence  
Installation Series: MRV IV + MRV S



Country: Pakistan  
Project Name: Interloop HD-2  
Installation Series: MRV S



# Reference Projects

Country: Pakistan  
Project Name: Lecole School  
Installation Series: MRV IV



Country: Pakistan  
Project Name: Khaadi Fabric Store Outlet at Com-3  
Installation Series: MRV 5



Country: Pakistan  
Project Name: CNS  
Installation Series: MRV-3C PLUS



Country: Pakistan  
Project Name: Dr. Ziauddin Hospital  
Installation Series: MRV 5



# Reference Projects

Country: Pakistan  
Project Name: Nagina Head Office's HVAC Project  
Installation Series: MRV 5



Country: Pakistan  
Project Name: Cybernet Pakistan  
Installation Series: MRV 5



Country: Poland  
Project Name: 46 Luxury Apartments  
Installation Series: 3 MRV IV-C systems, 1 MRV III-S system



Country: Poland  
Project Name: Hotel & Conference Center  
Installation Series: MRV III-C



# Reference Projects

Country: Poland  
Project Name: 4 Separate Building Designated for Buisness, Retail and Entertainment Purposes  
Installation Series: MRV III-C



Country: Poland  
Project Name: Stadium  
Installation Series: 5 MRV III-S systems

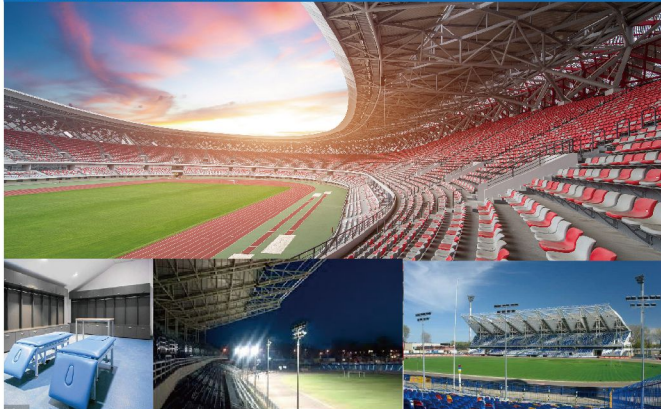

Country: Poland  
Project Name: 2000sq m, 3 Story Building  
Installation Series: MRV III-C



Country: Republic of Malta  
Project Name: Water Front  
Installation Series: MRV-IV



# Reference Projects

Country: Russia  
Project Name: Azimut  
Installation Series: MRV III - C; MRV -S



Country: Spain  
Project Name: Escuela de Hosteleria de Jerez  
Installation Series: MRV III Plus



Country: Spain  
Project Name: IMadrid University Project  
Installation Series: MRVIII-C



Country: Spain  
Project Name: Guarderia Hospital Niño Jesús  
Installation Series: MRV-S



# Reference Projects

Country: Thailand  
Project Name: The South Cuisine  
Installation Series: MRV III c-Plus



Country: Turkey  
Project Name: Caspian Shopping Center  
Installation Series: MRV 5



Country: Thailand  
Project Name: Royal Lee Dimension  
Installation Series: MRV IV



Country: Thailand  
Project Name: Uttarakit Hospital  
Installation Series: MRV III c-Plus



# Reference Projects

Date / /

Country: Thailand  
Project Name: Wandee Culinary Cook School  
Installation Series: MRV III-C PLUS



Country: Ukraine  
Project Name: IT-Center  
Installation Series: MRV 5



Date     /     /

