

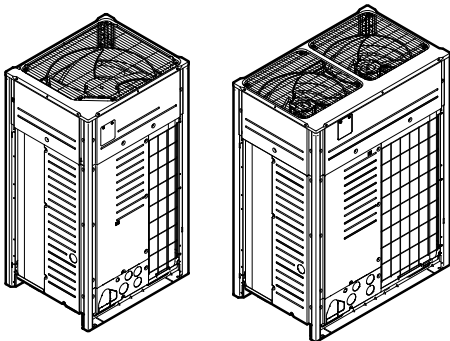

Installation and operation manual

VRV 5 heat recovery



VRV 5

REYA8A7Y1B
REYA10A7Y1B
REYA12A7Y1B
REYA14A7Y1B
REYA16A7Y1B
REYA18A7Y1B
REYA20A7Y1B

REMA5A7Y1B

Installation and operation manual
VRV 5 heat recovery

English

Lowest underground floor ^(a)

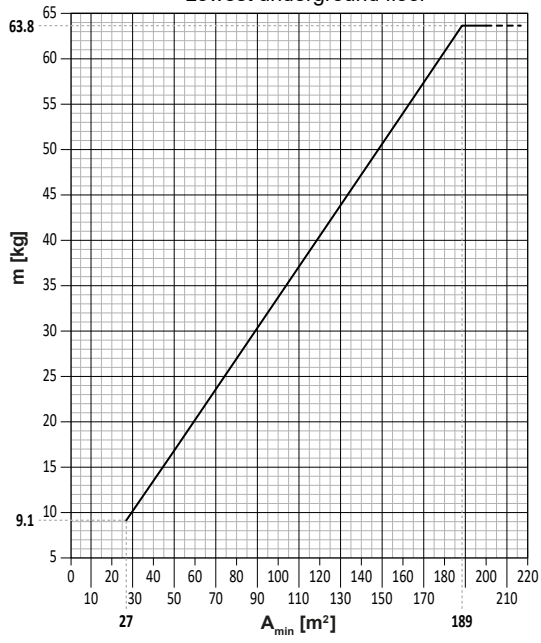

A_{\min} (m ²)	m (kg)
27	9.1
30	10.1
40	13.5
50	16.8
60	20.2
70	23.6
80	27.0
90	30.3
100	33.7
110	37.1
120	40.5
130	43.9
140	47.2
150	50.6
160	54.0
170	57.4
180	60.7
189	63.8
190	63.8
200	63.8

Table of contents

1 About this document	4	8.2.16 Symptom: The inside of an outdoor unit is warm even when the unit has stopped	15
2 Specific installer safety instructions	4	8.2.17 Symptom: Hot air can be felt when the indoor unit is stopped	15
2.1 Instructions for equipment using R32 refrigerant	6		
For the user	7	9 Relocation	15
3 User safety instructions	7	10 Disposal	15
3.1 General.....	7		
3.2 Instructions for safe operation	8	For the installer	16
4 About the system	10	11 About the box	16
4.1 System layout.....	10	11.1 To remove the accessories from the outdoor unit.....	16
5 User interface	10	11.2 Accessory pipes: Diameters.....	16
6 Operation	10	11.3 To remove the transportation stay (only for 5-12 HP)	16
6.1 Operation range	10	12 About the units and options	16
6.2 Operating the system	11	12.1 About the outdoor unit.....	16
6.2.1 About operating the system	11	12.2 System layout.....	17
6.2.2 About cooling, heating, fan only, and automatic operation	11	13 Special requirements for R32 units	17
6.2.3 About the heating operation.....	11	13.1 Installation space requirements.....	17
6.2.4 To operate the system	11	13.2 System layout requirements.....	17
6.3 Using the dry program.....	11	13.3 About the charge limit.....	19
6.3.1 About the dry program	11	13.4 To determine the charge limit.....	20
6.3.2 To use the dry program.....	11	14 Unit installation	23
6.4 Adjusting the air flow direction.....	11	14.1 Preparing the installation site	23
6.4.1 About the air flow flap	11	14.1.1 Installation site requirements of the outdoor unit	23
6.5 Setting the master user interface	12	14.1.2 Additional installation site requirements of the outdoor unit in cold climates	24
6.5.1 About setting the master user interface	12	14.2 Opening the unit	24
6.5.2 To designate the master user interface	12	14.2.1 To open the outdoor unit.....	24
7 Maintenance and service	12	14.2.2 To open the electrical component box of the outdoor unit	24
7.1 Precautions for maintenance and service	12	14.3 Mounting the outdoor unit.....	24
7.2 About the refrigerant.....	12	14.3.1 To provide the installation structure	24
7.3 After-sales service and warranty	12	14.3.2 To install the outdoor unit.....	25
7.3.1 Warranty period	12	15 Piping installation	25
7.3.2 Recommended maintenance and inspection.....	12	15.1 Preparing refrigerant piping	25
8 Troubleshooting	13	15.1.1 Refrigerant piping requirements.....	25
8.1 Error codes: Overview	13	15.1.2 Refrigerant piping material	25
8.2 Symptoms that are NOT system malfunctions	14	15.1.3 To select the piping size	25
8.2.1 Symptom: The system does not operate	14	15.1.4 To select refrigerant branch kits.....	26
8.2.2 Symptom: Fan operation is possible, but cooling and heating do not work.....	14	15.1.5 Multiple outdoor units: Possible layouts.....	26
8.2.3 Symptom: The fan speed does not correspond to the setting	14	15.2 Connecting the refrigerant piping	27
8.2.4 Symptom: The fan direction does not correspond to the setting	14	15.2.1 Using the stop valve and service port.....	27
8.2.5 Symptom: White mist comes out of a unit (Indoor unit)	15	15.2.2 To route the refrigerant piping.....	28
8.2.6 Symptom: White mist comes out of a unit (Indoor unit, outdoor unit)	15	15.2.3 To protect against contamination	28
8.2.7 Symptom: The user interface reads "U4" or "U5" and stops, but then restarts after a few minutes	15	15.2.4 To remove the pinched pipes.....	28
8.2.8 Symptom: Noise of air conditioners (Indoor unit).....	15	15.2.5 To connect the refrigerant piping to the outdoor unit ...	29
8.2.9 Symptom: Noise of air conditioners (Indoor unit, outdoor unit).....	15	15.2.6 To connect the multi connection piping kit.....	29
8.2.10 Symptom: Noise of air conditioners (Outdoor unit).....	15	15.2.7 To connect the refrigerant branching kit	29
8.2.11 Symptom: Dust comes out of the unit.....	15	15.3 Checking the refrigerant piping	29
8.2.12 Symptom: The units can give off odours.....	15	15.3.1 About checking the refrigerant piping	29
8.2.13 Symptom: The outdoor unit fan does not spin	15	15.3.2 Checking refrigerant piping: General guidelines.....	30
8.2.14 Symptom: The display shows "88".....	15	15.3.3 Checking refrigerant piping: Setup.....	30
8.2.15 Symptom: The compressor in the outdoor unit does not stop after a short heating operation	15	15.3.4 To perform a leak test	30
		15.3.5 To perform vacuum drying	31
		15.3.6 To insulate the refrigerant piping	31
		15.3.7 To check for leaks after charging refrigerant	31
		16 Charging refrigerant	31
		16.1 Precautions when charging refrigerant.....	31
		16.2 About charging refrigerant.....	32
		16.3 To determine the additional refrigerant amount	32
		16.4 To charge refrigerant: Flow chart	34
		16.5 To charge refrigerant.....	34
		16.6 Error codes when charging refrigerant	35
		16.7 Checks after charging refrigerant	35

1 About this document

16.8	To fix the fluorinated greenhouse gases label.....	35
16.9	To check refrigerant piping joints for leaks after charging refrigerant.....	36
17	Electrical installation	36
17.1	About electrical compliance.....	36
17.2	Specifications of standard wiring components.....	37
17.3	To route and fix the interconnection wiring.....	37
17.4	To connect the interconnection wiring.....	38
17.5	To finish the interconnection wiring.....	38
17.6	To route and fix the power supply.....	38
17.7	To connect the power supply.....	39
17.8	To connect the external outputs.....	39
17.9	To check the insulation resistance of the compressor.....	40
18	Configuration	40
18.1	Making field settings.....	40
18.1.1	About making field settings.....	40
18.1.2	Field setting components.....	41
18.1.3	To access the field setting components.....	41
18.1.4	To access mode 1 or 2.....	41
18.1.5	To use mode 1.....	42
18.1.6	To use mode 2.....	42
18.1.7	Mode 1: monitoring settings.....	42
18.1.8	Mode 2: field settings.....	42
18.2	Using the leak detection function.....	44
18.2.1	About automatic leak detection.....	44
19	Commissioning	44
19.1	Precautions when commissioning.....	44
19.2	Checklist before commissioning.....	45
19.3	Checklist during commissioning.....	45
19.4	About the BS unit test run.....	45
19.5	About the system test run.....	45
19.5.1	To perform a test run.....	46
19.5.2	Correcting after abnormal completion of the test run.....	46
19.6	To perform a BS/indoor unit connection check.....	46
20	Hand-over to the user	47
21	Maintenance and service	47
21.1	Maintenance safety precautions.....	47
21.1.1	To prevent electrical hazards.....	47
21.2	Checklist for yearly maintenance of the outdoor unit.....	47
21.3	About service mode operation.....	47
21.3.1	To use vacuum mode.....	47
21.3.2	To recover refrigerant.....	48
22	Troubleshooting	48
22.1	Solving problems based on error codes.....	48
22.1.1	Error codes: Overview.....	48
22.2	Refrigerant leak detection system.....	52
23	Disposal	53
24	Technical data	53
24.1	Service space: Outdoor unit.....	53
24.2	Piping diagram: Outdoor unit.....	55
24.3	Wiring diagram: Outdoor unit.....	57
25	Glossary	58

1 About this document

Target audience

Authorised installers + end users



INFORMATION

This appliance is intended to be used by expert or trained users in shops, in light industry and on farms, or for commercial use by lay persons.

Documentation set

This document is part of a documentation set. The complete set consists of:

- **General safety precautions:**
 - Safety instructions that you must read before installing
 - Format: paper (in the box of the outdoor unit)
- **Outdoor unit installation and operation manual:**
 - Installation and operation instructions
 - Format: paper (in the box of the outdoor unit)
- **Installer and user reference guide:**
 - Preparation of the installation, reference data,...
 - Detailed step-by-step instructions and background information for basic and advanced usage
 - Format: Digital files on <https://www.daikin.eu>. Use the search function 🔍 to find your model.

Latest revisions of the supplied documentation may be available on the regional Daikin website or via your dealer.

The original instructions are written in English. All other languages are translations of the original instructions.

2 Specific installer safety instructions

Always observe the following safety instructions and regulations.

Installation site (see "14.1 Preparing the installation site" ▶ 23)



WARNING

Follow the service space dimensions in this manual for correct installation of the unit. See "24.1 Service space: Outdoor unit" ▶ 53].



WARNING

Tear apart and throw away plastic packaging bags so that nobody, especially NOT children, can play with them.
Possible consequence: suffocation.



CAUTION

Appliance NOT accessible to the general public, install it in a secured area, protected from easy access.

This unit, both indoor and outdoor, is suitable for installation in a commercial and light industrial environment.



CAUTION

This equipment is NOT intended for use in residential locations and will NOT guarantee to provide adequate protection to radio reception in such locations.



CAUTION

Excessive refrigerant concentrations in a closed room can lead to oxygen deficiency.



WARNING

If the appliance contains R32 refrigerant, the floor area of the room in which the appliance is stored shall be at least 956 m².



WARNING

If one or more rooms are connected to the unit using a duct system, make sure:

- there are no operating ignition sources (example: open flames, an operating gas appliance or an operating electric heater) in case the floor area is less than the minimum floor area A (m²).
- no auxiliary devices, which may be a potential ignition source, are installed in the duct work (example: hot surfaces with a temperature exceeding 700°C and electric switching device);
- only auxiliary devices approved by the manufacturer are used in the duct work;
- air inlet AND outlet are connected directly to the same room by ducting. Do NOT use spaces such as a false ceiling as a duct for the air inlet or outlet.

Opening the unit (see "[14.2 Opening the unit](#)" [p 24])



DANGER: RISK OF BURNING/SCALDING



DANGER: RISK OF ELECTROCUTION



DANGER: RISK OF ELECTROCUTION

Do NOT leave the unit unattended when the service cover is removed.

Mounting the outdoor unit (see "[14.3 Mounting the outdoor unit](#)" [p 24])



WARNING

Fixing method of the outdoor unit MUST be in accordance with the instructions from this manual. See "[14.3 Mounting the outdoor unit](#)" [p 24].

Connecting the refrigerant piping (see "[15.2 Connecting the refrigerant piping](#)" [p 27])



WARNING

The field piping method MUST be in accordance with the instructions from this manual. See "[15 Piping installation](#)" [p 25].



CAUTION

- Do NOT use mineral oil on flared part.
- Do NOT reuse piping from previous installations.
- NEVER install a drier to this unit to guarantee its lifetime. The drying material may dissolve and damage the system.



CAUTION

Install the refrigerant piping or components in a position where they are unlikely to be exposed to any substance which may corrode components containing refrigerant, unless the components are constructed of materials that are inherently resistant to corrosion or are suitably protected against corrosion.



WARNING

Take sufficient precautions in case of refrigerant leakage. If refrigerant gas leaks, ventilate the area immediately. Possible risks:

- Excessive refrigerant concentrations in a closed room can lead to oxygen deficiency.
- Toxic gas might be produced if refrigerant gas comes into contact with fire.



WARNING

ALWAYS recover the refrigerant. Do NOT release them directly into the environment. Use a vacuum pump to evacuate the installation.



WARNING

During tests, NEVER pressurise the product with a pressure higher than the maximum allowable pressure (as indicated on the nameplate of the unit).



CAUTION

Do NOT vent gases into the atmosphere.



WARNING

Any gas or oil remaining inside the stop valve may blow off the pinched piping.

Failure to observe the instructions in procedure below properly may result in property damage or personal injury, which may be serious depending on the circumstances.



WARNING



NEVER remove the pinched piping by brazing.

Any gas or oil remaining inside the stop valve may blow off the pinched piping.

Charging refrigerant (see "[16 Charging refrigerant](#)" [p 31])



WARNING

- The refrigerant inside the unit is mildly flammable, but normally does NOT leak. If the refrigerant leaks in the room and comes in contact with fire from a burner, a heater, or a cooker, this may result in fire, or the formation of a harmful gas.
- Turn OFF any combustible heating devices, ventilate the room, and contact the dealer where you purchased the unit.
- Do NOT use the unit until a service person confirms that the part from which the refrigerant leaked has been repaired.



WARNING

Charging of refrigerant MUST be in accordance with the instructions from this manual. See "[16 Charging refrigerant](#)" [p 31].



WARNING

- Only use R32 as refrigerant. Other substances may cause explosions and accidents.
- R32 contains fluorinated greenhouse gases. Its global warming potential (GWP) value is 675. Do NOT vent these gases into the atmosphere.
- When charging refrigerant, ALWAYS use protective gloves and safety glasses.

2 Specific installer safety instructions

Electrical installation (see "17 Electrical installation" [p 36])



WARNING

Electrical wiring connection method **MUST** be in accordance with the instructions from:

- This manual. See "17 Electrical installation" [p 36].
- The wiring diagram, which is delivered with the unit, located at the inside of the service cover. For a translation of its legend, see "24.3 Wiring diagram: Outdoor unit" [p 57].



WARNING

The appliance **MUST** be installed in accordance with national wiring regulations.



CAUTION

Do **NOT** push or place redundant cable length into the unit.



WARNING

- If the power supply has a missing or wrong N-phase, equipment might break down.
- Establish proper earthing. Do **NOT** earth the unit to a utility pipe, surge absorber, or telephone earth. Incomplete earthing may cause electrical shocks.
- Install the required fuses or circuit breakers.
- Secure the electrical wiring with cable ties so that the cables do **NOT** come in contact with sharp edges or piping, particularly on the high-pressure side.
- Do **NOT** use taped wires, extension cords, or connections from a star system. They can cause overheating, electrical shocks or fire.
- Do **NOT** install a phase advancing capacitor, because this unit is equipped with an inverter. A phase advancing capacitor will reduce performance and may cause accidents.



WARNING

- All wiring **MUST** be performed by an authorised electrician and **MUST** comply with the applicable national wiring regulation.
- Make electrical connections to the fixed wiring.
- All components procured on-site and all electrical construction **MUST** comply with the applicable legislation.



WARNING

If the supply cord is damaged, it **MUST** be replaced by the manufacturer, its service agent or similarly qualified persons in order to avoid a hazard.



WARNING

ALWAYS use multicore cable for power supply cables.



CAUTION

- When connecting the power supply: connect the earth cable first, before making the current-carrying connections.
- When disconnecting the power supply: disconnect the current-carrying cables first, before separating the earth connection.
- The length of the conductors between the power supply stress relief and the terminal block itself **MUST** be as such that the current-carrying wires are tautened before the earth wire is in case the power supply is pulled loose from the stress relief.

Commissioning (see "19 Commissioning" [p 44])



WARNING

Commissioning method **MUST** be in accordance with the instructions from this manual. See "19 Commissioning" [p 44].



CAUTION

Do **NOT** perform the test operation while working on the indoor units.

When performing the test operation, **NOT ONLY** the outdoor unit, but the connected indoor unit will operate as well. Working on an indoor unit while performing a test operation is dangerous.



CAUTION

Do **NOT** insert fingers, rods or other objects into the air inlet or outlet. Do **NOT** remove the fan guard. When the fan is rotating at high speed, it will cause injury.

Troubleshooting (see "22 Troubleshooting" [p 48])



WARNING

- When carrying out an inspection on the switch box of the unit, **ALWAYS** make sure that the unit is disconnected from the mains. Turn off the respective circuit breaker.
- When a safety device was activated, stop the unit and find out why the safety device was activated before resetting it. **NEVER** shunt safety devices or change their values to a value other than the factory default setting. If you are unable to find the cause of the problem, call your dealer.



WARNING

Prevent hazards due to inadvertent resetting of the thermal cut-out: power to this appliance **MUST NOT** be supplied through an external switching device, such as a timer, or connected to a circuit that is regularly turned **ON** and **OFF** by the utility.

2.1 Instructions for equipment using R32 refrigerant



A2L

WARNING: MILDLY FLAMMABLE MATERIAL

The refrigerant inside this unit is mildly flammable.



WARNING

- Do **NOT** pierce or burn refrigerant cycle parts.
- Do **NOT** use cleaning materials or means to accelerate the defrosting process other than those recommended by the manufacturer.
- Be aware that the refrigerant inside the system is odourless.



WARNING

The appliance shall be stored as follows:

- in such a way as to prevent mechanical damage.
- in a well-ventilated room without continuously operating ignition sources (example: open flames, an operating gas appliance or an operating electric heater).
- in a room with dimensions as specified in "13 Special requirements for R32 units" [p 17].



WARNING

Make sure installation, servicing, maintenance and repair comply with instructions from Daikin and with applicable legislation and are executed **ONLY** by authorised persons.



WARNING

- Take precautions to avoid excessive vibration or pulsation to refrigeration piping.
- Protect the protection devices, piping and fittings as much as possible against adverse environmental effects.
- Provide space for expansion and contraction of long runs of piping.
- Design and install piping in refrigerating systems such as to minimise the likelihood of hydraulic shock damaging the system.
- Mount the indoor equipment and pipes securely and protect them to avoid accidental rupture of equipment or pipes in case of events such as moving furniture or reconstruction activities.



CAUTION

Do **NOT** use potential sources of ignition in searching for or detection of refrigerant leaks.



NOTICE

- Do **NOT** re-use joints and copper gaskets which have been used already.
- Joints made in installation between parts of refrigerant system shall be accessible for maintenance purposes.

See "13.4 To determine the charge limit" [▶ 20] to check if your system meets the requirement for charge limitation.

For the user

3 User safety instructions

Always observe the following safety instructions and regulations.

3.1 General



WARNING

If you are **NOT** sure how to operate the unit, contact your installer.



WARNING

This appliance can be used by children aged from 8 years and above and persons with reduced physical, sensory or mental capabilities or lack of experience and knowledge if they have been given supervision or instruction concerning use of the appliance in a safe way and understand the hazards involved.

Children **SHALL NOT** play with the appliance.

Cleaning and user maintenance **SHALL NOT** be made by children without supervision.



WARNING

To prevent electrical shocks or fire:

- Do **NOT** rinse the unit.

- Do **NOT** operate the unit with wet hands.
- Do **NOT** place any objects containing water on the unit.



CAUTION

- Do **NOT** place any objects or equipment on top of the unit.
- Do **NOT** sit, climb or stand on the unit.

- Units are marked with the following symbol:



This means that electrical and electronic products may **NOT** be mixed with unsorted household waste. Do **NOT** try to dismantle the system yourself: dismantling the system, treatment of the refrigerant, of oil and of other parts **MUST** be done by an authorised installer and **MUST** comply with applicable legislation.

Units **MUST** be treated at a specialised treatment facility for reuse, recycling and recovery. By ensuring this product is disposed of correctly, you will help to prevent potential negative consequences for the environment and human health. For more information, contact your installer or local authority.

3 User safety instructions

- Batteries are marked with the following symbol:



This means that the batteries may NOT be mixed with unsorted household waste. If a chemical symbol is printed beneath the symbol, this chemical symbol means that the battery contains a heavy metal above a certain concentration.

Possible chemical symbols are: Pb: lead (>0.004%).

Waste batteries MUST be treated at a specialised treatment facility for reuse. By ensuring waste batteries are disposed of correctly, you will help to prevent potential negative consequences for the environment and human health.

3.2 Instructions for safe operation

WARNING

Make sure installation, servicing, maintenance, repair and applied materials follow the instructions from Daikin (including all documents listed in "Documentation set") and, in addition, comply with applicable legislation and are performed by qualified persons only. In Europe and areas where IEC standards apply, EN/IEC 60335-2-40 is the applicable standard.

WARNING

Do NOT install operating ignition sources (example: open flames, an operating gas appliance or an operating electric heater) in the ductwork.

CAUTION

- NEVER touch the internal parts of the controller.
- Do NOT remove the front panel. Some parts inside are dangerous to touch and appliance problems may happen. For checking and adjusting the internal parts, contact your dealer.

CAUTION

Do NOT operate the system when using a room fumigation-type insecticide. Chemicals could collect in the unit, and endanger the health of people who are hypersensitive to chemicals.

CAUTION

It is unhealthy to expose your body to the air flow for a long time.

WARNING

This unit contains electrical and hot parts.

WARNING

Before operating the unit, be sure the installation has been carried out correctly by an installer.

Maintenance and service (see "7 Maintenance and service" [p 12])

WARNING

The unit is equipped with a refrigerant leak detection system for safety. To be effective, the unit MUST be electrically powered at all times after installation, except for maintenance.

WARNING

NEVER replace a fuse with a fuse of a wrong ampere ratings or other wires when a fuse blows out. Use of wire or copper wire may cause the unit to break down or cause a fire.

WARNING

If the supply cord is damaged, it MUST be replaced by the manufacturer, its service agent or similarly qualified persons in order to avoid a hazard.

CAUTION

Do NOT insert fingers, rods or other objects into the air inlet or outlet. Do NOT remove the fan guard. When the fan is rotating at high speed, it will cause injury.

CAUTION: Pay attention to the fan!

It is dangerous to inspect the unit while the fan is running.

Make sure to turn OFF the main switch before executing any maintenance task.

 **CAUTION**

After a long use, check the unit stand and fitting for damage. If damaged, the unit may fall and result in injury.

About the refrigerant (see "7.2 About the refrigerant" [p 12])

 **WARNING: MILDLY FLAMMABLE MATERIAL**

The refrigerant inside this unit is mildly flammable.

 **WARNING**

- The refrigerant inside the unit is mildly flammable, but normally does NOT leak. If the refrigerant leaks in the room and comes in contact with fire from a burner, a heater, or a cooker, this may result in fire, or the formation of a harmful gas.
- Turn OFF any combustible heating devices, ventilate the room, and contact the dealer where you purchased the unit.
- Do NOT use the unit until a service person confirms that the part from which the refrigerant leaked has been repaired.

 **WARNING**

The appliance shall be stored in a room without continuously operating ignition sources (example: open flames, an operating gas appliance or an operating electric heater).

 **WARNING**

- Do NOT pierce or burn refrigerant cycle parts.
- Do NOT use cleaning materials or means to accelerate the defrosting process other than those recommended by the manufacturer.
- Be aware that the refrigerant inside the system is odourless.

After-sales service and warranty (see "7.3 After-sales service and warranty" [p 12])

 **WARNING**

- Do NOT modify, disassemble, remove, reinstall or repair the unit yourself as incorrect dismantling or installation may cause an electrical shock or fire. Contact your dealer.
- In case of accidental refrigerant leaks, make sure there are no naked flames. The refrigerant itself is entirely safe, non-toxic and mildly flammable, but it will generate toxic gas when it accidentally leaks into a room where combustible air from fan heaters, gas cookers, etc. is present. Always have qualified service personnel confirm that the point of leakage has been repaired or corrected before resuming operation.

Troubleshooting (see "8 Troubleshooting" [p 13])

 **WARNING**

Stop operation and shut OFF the power if anything unusual occurs (burning smells etc.).

Leaving the unit running under such circumstances may cause breakage, electrical shock or fire. Contact your dealer.

 **WARNING**

The unit is equipped with a refrigerant leak detection system for safety.

To be effective, the unit MUST be electrically powered at all times after installation, except for maintenance.

 **CAUTION**

NEVER expose little children, plants or animals directly to the airflow.

 **CAUTION**

Do NOT touch the heat exchanger fins. These fins are sharp and could result in cutting injuries.

4 About the system

4 About the system

The VRV 5 uses R32 refrigerant which is rated as A2L and is mildly flammable. For compliance with the requirements for enhanced tightness refrigerating systems and IEC60335-2-40 the installer must take extra measures. For more information, see "2.1 Instructions for equipment using R32 refrigerant" [p. 6].

The indoor unit part of this VRV 5 heat recovery system can be used for heating/cooling applications. The type of indoor unit which can be used depends on the outdoor unit series.

WARNING

- Do NOT modify, disassemble, remove, reinstall or repair the unit yourself as incorrect dismantling or installation may cause an electrical shock or fire. Contact your dealer.
- In case of accidental refrigerant leaks, make sure there are no naked flames. The refrigerant itself is entirely safe, non-toxic and mildly flammable, but it will generate toxic gas when it accidentally leaks into a room where combustible air from fan heaters, gas cookers, etc. is present. Always have qualified service personnel confirm that the point of leakage has been repaired or corrected before resuming operation.

WARNING

The unit is equipped with a refrigerant leak detection system for safety.

To be effective, the unit MUST be electrically powered at all times after installation, except for short service periods.

NOTICE

Do NOT use the system for other purposes. In order to avoid any quality deterioration, do NOT use the unit for cooling precision instruments, food, plants, animals, or works of art.

NOTICE

For future modifications or expansions of your system:

A full overview of allowable combinations (for future system extensions) is available in technical engineering data and should be consulted. Contact your installer to receive more information and professional advice.

4.1 System layout

Your VRV 5 heat recovery series outdoor unit can be one of following models:

Model	Description
REYA8~20	Heat recovery model for single or multi-use
REMA5	Heat recovery model for multi-use only

Depending on the type of outdoor unit which is chosen, some functionality will or will not exist. It will be indicated throughout this operation manual when certain features have exclusive model rights or not.

The complete system can be divided into several sub-systems. These sub-systems have 100% independence regarding the selection of cooling and heating operation, and each consists of one individual branch set of a BS unit, and all indoor units connected downstream.

INFORMATION

The following figure is an example and may NOT completely match your system layout

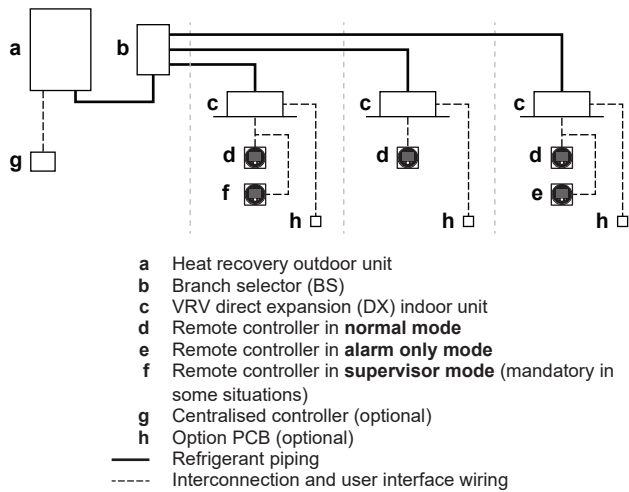

5 User interface

CAUTION

- NEVER touch the internal parts of the controller.
- Do NOT remove the front panel. Some parts inside are dangerous to touch and appliance problems may happen. For checking and adjusting the internal parts, contact your dealer.

This operation manual offers a non-exhaustive overview of the main functions of the system.

Detailed information on required actions to achieve certain functions can be found in the dedicated installation and operation manual of the indoor unit.

Refer to the operation manual of the installed user interface.

6 Operation

6.1 Operation range

Use the system in the following temperature and humidity ranges for safe and effective operation.

	Cooling	Heating
Outdoor temperature	-5~46°C DB	-20~20°C DB -20~15.5°C WB
Indoor temperature	21~32°C DB 14~25°C WB	15~27°C DB
Indoor humidity	≤80% ^(a)	

^(a) To avoid condensation and water dripping out of the unit. If the temperature or the humidity is beyond these conditions, safety devices may be put in action and the air conditioner may not operate.

Above operation range is only valid in case direct expansion indoor units are connected to the VRV 5 system.



Special operation ranges are valid in case of using Hydrobox units or AHU. They can be found in the installation/operation manual of the dedicated unit. Latest information can be found in the technical engineering data.

6.2 Operating the system

6.2.1 About operating the system

- Operation procedure varies according to the combination of outdoor unit and user interface.
- To protect the unit, turn on the main power switch 6 hours before operation.
- If the main power supply is turned off during operation, operation will restart automatically after the power turns back on again.

6.2.2 About cooling, heating, fan only, and automatic operation

- Changeover cannot be made with a user interface whose display shows  "change-over under centralised control" (refer to installation and operation manual of the user interface).
- When the display  "change-over under centralised control" flashes, refer to "6.5.1 About setting the master user interface" [▶ 12](#).
- The fan may keep on running for about 1 minute after the heating operation stops.
- The air flow rate may adjust itself depending on the room temperature or the fan may stop immediately. This is not a malfunction.

6.2.3 About the heating operation

It may take longer to reach the set temperature for general heating operation than for cooling operation.

The following operation is performed in order to prevent the heating capacity from dropping or cold air from blowing.

Defrost operation

In heating operation, freezing of the outdoor unit's air cooled coil increases over time, restricting the energy transfer to the outdoor unit's coil. Heating capability decreases and the system needs to go into defrost operation to be able to remove frost from the outdoor unit's coil. During defrost operation the heating capacity on the indoor unit side will temporarily drop until defrosting is completed. After defrosting, the unit will regain its full heating capacity.



In case of	Then
REYA10~28 (multi-use models)	The indoor unit will continue heating operation at a reduced level during defrost operation. It will guarantee a decent comfort level indoor.
REYA8~20 (single-use models)	The indoor unit will stop fan operation, the refrigerant cycle will reverse and energy from inside the building will be used to defrost the outdoor unit coil.

The indoor unit will indicate defrost operation on the display .

Hot start

In order to prevent cold air from blowing out of an indoor unit at the start of heating operation, the indoor fan is automatically stopped. The display of the user interface shows . It may take some time before the fan starts. This is not a malfunction.

6.2.4 To operate the system

- 1 Press the operation mode selector button on the user interface several times and select the operation mode of your choice.
 -  Cooling operation
 -  Heating operation
 -  Fan only operation

- 2 Press the ON/OFF button on the user interface.

Result: The operation lamp lights up and the system starts operating.

6.3 Using the dry program

6.3.1 About the dry program

- The function of this program is to decrease the humidity in your room with minimal temperature decrease (minimal room cooling).
- The micro computer automatically determines temperature and fan speed (cannot be set by the user interface).
- The system does not go into operation if the room temperature is low (<20°C).

6.3.2 To use the dry program

To start

- 1 Press the operation mode selector button on the user interface several times and select  (program dry operation).
- 2 Press the ON/OFF button of the user interface.

Result: The operation lamp lights up and the system starts operating.
- 3 Press the air flow direction adjust button (only for double-flow, multi-flow, corner, ceiling-suspended and wall-mounted). Refer to "6.4 Adjusting the air flow direction" [▶ 11](#) for details.

To stop

- 4 Press the ON/OFF button on the user interface once again.

Result: The operation lamp goes out and the system stops operating.



NOTICE



Do not turn off power immediately after the unit stops, but wait for at least 5 minutes.

6.4 Adjusting the air flow direction

Refer to the operation manual of the user interface.

6.4.1 About the air flow flap

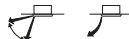
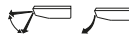
Air flow flap types:



-  Double flow + multi-flow units
-  Corner units
-  Ceiling suspended units
-  Wall-mounted units

For the following conditions, a micro computer controls the air flow direction which may be different from the display.

Cooling	Heating
<ul style="list-style-type: none"> • When the room temperature is lower than the set temperature. 	<ul style="list-style-type: none"> • When starting operation. • When the room temperature is higher than the set temperature. • At defrost operation.
<ul style="list-style-type: none"> • When operating continuously at horizontal air flow direction. 	<ul style="list-style-type: none"> • When continuous operation with downward air flow is performed at the time of cooling with a ceiling-suspended or a wall-mounted unit, the micro computer may control the flow direction, and then the user interface indication will also change.

7 Maintenance and service

The air flow direction can be adjusted in one of the following ways:

- The air flow flap itself adjusts its position.
- The air flow direction can be fixed by the user.
- Automatic  and desired position .

WARNING

NEVER touch the air outlet or the horizontal blades while the swing flap is in operation. Fingers may become caught or the unit may break down.

NOTICE

- The movable limit of the flap is changeable. Contact your dealer for details. (only for double-flow, multi-flow, corner, ceiling-suspended and wall-mounted).
- Avoid operating in the horizontal direction . It may cause dew or dust to settle on the ceiling or flap.

6.5 Setting the master user interface

6.5.1 About setting the master user interface

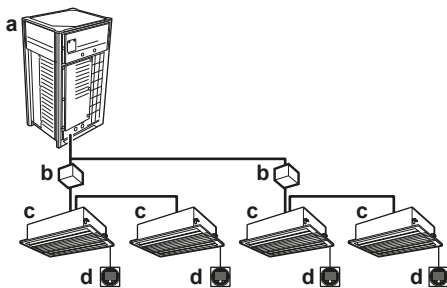

- a Outdoor unit
- b BS unit
- c VRV DX indoor unit
- d User interface

When the system is installed as shown in the figure above, it is necessary to – for each subsystem – designate one of the user interfaces as the master user interface.

The displays of slave user interfaces show  (change-over under centralised control) and slave user interfaces automatically follow the operation mode directed by the master user interface.



Only the master user interface can select heating or cooling mode.

6.5.2 To designate the master user interface

- 1 Press the operation mode selector button of the current master user interface for 4 seconds. In case this procedure was not yet performed, the procedure can be executed on the first user interface operated.

Result: The display showing  (change-over under centralised control) of all slave user interfaces connected to the same outdoor unit flashes.

- 2 Press the operation mode selector button of the controller that you wish to designate as the master user interface.

Result: Designation is completed. This user interface is designated as the master user interface and the display showing  (change-over under centralised control) vanishes. The displays of other user interfaces show  (change-over under centralised control).

7 Maintenance and service

7.1 Precautions for maintenance and service

CAUTION

See "3 User safety instructions" [▶ 7] to acknowledge all related safety instructions.

NOTICE

NEVER inspect or service the unit by yourself. Ask a qualified service person to perform this work.

NOTICE

Do NOT wipe the controller operation panel with benzine, thinner, chemical dust cloth, etc. The panel may get discoloured or the coating peeled off. If it is heavily dirty, soak a cloth in water-diluted neutral detergent, squeeze it well and wipe the panel clean. Wipe it with another dry cloth.

7.2 About the refrigerant

CAUTION

See "3 User safety instructions" [▶ 7] to acknowledge all related safety instructions.

This product contains fluorinated greenhouse gases. Do NOT vent gases into the atmosphere.

Refrigerant type: R32

Global warming potential (GWP) value: 675

Periodical inspections for refrigerant leaks may be required depending on the applicable legislation. Contact your installer for more information.

NOTICE

Applicable legislation on **fluorinated greenhouse gases** requires that the refrigerant charge of the unit is indicated both in weight and CO₂ equivalent.

Formula to calculate the quantity in CO₂ equivalent tonnes: GWP value of the refrigerant × total refrigerant charge [in kg]/1000

Contact your installer for more information.

7.3 After-sales service and warranty

7.3.1 Warranty period

- This product includes a warranty card that was filled in by the dealer at the time of installation. The completed card has to be checked by the customer and stored carefully.
- If repairs to the product are necessary within the warranty period, contact your dealer and keep the warranty card at hand.

7.3.2 Recommended maintenance and inspection

Since dust collects when using the unit for several years, performance of the unit will deteriorate to some extent. As taking apart and cleaning interiors of units requires technical expertise and in order to ensure the best possible maintenance of your units, we recommend to enter into a maintenance and inspection contract on top of normal maintenance activities. Our network of dealers has

access to a permanent stock of essential components in order to keep your unit in operation as long as possible. Contact your dealer for more information.

When asking your dealer for an intervention, always state:

- The complete model name of the unit.
- The manufacturing number (stated on the nameplate of the unit).
- The installation date.
- The symptoms or malfunction, and details of the defect.

⚠ WARNING

- Do NOT modify, disassemble, remove, reinstall or repair the unit yourself as incorrect dismantling or installation may cause an electrical shock or fire. Contact your dealer.
- In case of accidental refrigerant leaks, make sure there are no naked flames. The refrigerant itself is entirely safe, non-toxic and mildly flammable, but it will generate toxic gas when it accidentally leaks into a room where combustible air from fan heaters, gas cookers, etc. is present. Always have qualified service personnel confirm that the point of leakage has been repaired or corrected before resuming operation.

8 Troubleshooting

If one of the following malfunctions occur, take the measures shown below and contact your dealer.

⚠ WARNING

Stop operation and shut OFF the power if anything unusual occurs (burning smells etc.).

Leaving the unit running under such circumstances may cause breakage, electrical shock or fire. Contact your dealer.

The system MUST be repaired by a qualified service person.

Malfunction	Measure
If a safety device such as a fuse, a breaker or an earth leakage breaker frequently actuates or the ON/OFF switch does NOT properly work.	Turn OFF the main power switch.
The operation switch does NOT work well.	Turn OFF the power supply.
If the user interface display indicates the unit number, the operation lamp flashes and the malfunction code appears.	Notify your installer and report the malfunction code.

If the system does NOT operate properly except for the above mentioned cases and none of the above mentioned malfunctions is evident, investigate the system in accordance with the following procedures.

Malfunction	Measure
If a refrigerant leak occurs (error code <i>RQ/CH</i>)	<ul style="list-style-type: none"> ▪ Actions will be taken by the system. Do NOT turn OFF the power supply. ▪ Notify your installer and report the malfunction code.
If the system does not operate at all.	<ul style="list-style-type: none"> ▪ Check if there is no power failure. Wait until power is restored. If power failure occurs during operation, the system automatically restarts immediately after power is restored. ▪ Check if no fuse has blown or breaker is activated. Change the fuse or reset the breaker if necessary.

Malfunction	Measure
If the system goes into fan only operation, but as soon as it goes into heating or cooling operation, the system stops.	<ul style="list-style-type: none"> ▪ Check if air inlet or outlet of outdoor or indoor unit is not blocked by obstacles. Remove any obstacles and make sure the air can flow freely. ▪ Check if the user interface display shows on the home screen. Refer to the installation and operation manual delivered with the indoor unit.
The system operates but cooling or heating is insufficient.	<ul style="list-style-type: none"> ▪ Check if air inlet or outlet of outdoor or indoor unit is not blocked by obstacles. Remove any obstacles and make sure the air can flow freely. ▪ Check if the air filter is not clogged (refer to "Maintenance" in the indoor unit manual). ▪ Check the temperature setting. ▪ Check the fan speed setting on your user interface. ▪ Check for open doors or windows. Close doors and windows to prevent wind from coming in. ▪ Check if there are too many occupants in the room during cooling operation. Check if the heat source of the room is excessive. ▪ Check if direct sunlight enters the room. Use curtains or blinds. ▪ Check if the air flow angle is proper.

If after checking all above items, it is impossible to fix the problem yourself, contact your installer and state the symptoms, the complete model name of the unit (with manufacturing number if possible) and the installation date (possibly listed on the warranty card).

8.1 Error codes: Overview

In case a malfunction code appears on the indoor unit user interface display, contact your installer and inform the malfunction code, the unit type, and serial number (you can find this information on the nameplate of the unit).

For your reference, a list with malfunction codes is provided. You can, depending on the level of the malfunction code, reset the code by pushing the ON/OFF button. If not, ask your installer for advice.

Main code	Contents
<i>RQ</i>	External protection device was activated
<i>RQ-11</i>	The R32 sensor in one of the indoor units has detected a refrigerant leak ^(a)
<i>RQ-20</i>	The R32 sensor in one of the BS unit has detected a refrigerant leak.
<i>RQICH</i>	Safety system error (leak detection) ^(a)
<i>R1</i>	EEPROM failure (indoor)
<i>R3</i>	Drain system malfunction (indoor/BS unit)
<i>R6</i>	Fan motor malfunction (indoor)
<i>R7</i>	Swing flap motor malfunction (indoor)
<i>R9</i>	Expansion valve malfunction (indoor)
<i>RF</i>	Drain malfunction (indoor unit)
<i>RH</i>	Filter dust chamber malfunction (indoor)
<i>RJ</i>	Capacity setting malfunction (indoor)
<i>C1</i>	Transmission malfunction between main PCB and sub PCB (indoor)
<i>C4</i>	Heat exchanger thermistor malfunction (indoor; liquid)

8 Troubleshooting

Main code	Contents
<i>C5</i>	Heat exchanger thermistor malfunction (indoor; gas)
<i>C9</i>	Suction air thermistor malfunction (indoor)
<i>CR</i>	Discharge air thermistor malfunction (indoor)
<i>CE</i>	Movement detector or floor temperature sensor malfunction (indoor)
<i>CH-01</i>	R32 sensor malfunction in one of the indoor units ^(a)
<i>CH-02</i>	R32 sensor end of lifetime in one of the indoor units ^(a)
<i>CH-05</i>	R32 sensor end of lifetime < 6 months in one of the indoor units ^(a)
<i>CH-10</i>	Waiting for indoor unit R32 sensor replacement input ^(a)
<i>CH-20</i>	Waiting for BS unit replacement input
<i>CJ</i>	User interface thermistor malfunction (indoor)
<i>E1</i>	PCB malfunction (outdoor)
<i>E2</i>	Current leakage detector was activated (outdoor)
<i>E3</i>	High pressure switch was activated
<i>E4</i>	Low pressure malfunction (outdoor)
<i>E5</i>	Compressor lock detection (outdoor)
<i>E7</i>	Fan motor malfunction (outdoor)
<i>E9</i>	Electronic expansion valve malfunction (outdoor)
<i>EA-27</i>	BS unit damper malfunction
<i>F3</i>	Discharge temperature malfunction (outdoor)
<i>F4</i>	Abnormal suction temperature (outdoor)
<i>F6</i>	Refrigerant overcharge detection
<i>H3</i>	High pressure switch malfunction
<i>H4</i>	Low pressure switch malfunction
<i>H7</i>	Fan motor malfunction (outdoor)
<i>H9</i>	Ambient temperature sensor malfunction (outdoor)
<i>J3</i>	Discharge temperature sensor malfunction (outdoor)
<i>J5</i>	Suction temperature sensor malfunction (outdoor)
<i>J6</i>	De-icing temperature sensor malfunction (outdoor) or heat exchanger gas temperature sensor malfunction (outdoor)
<i>J7</i>	Liquid temperature sensor (after subcool HE) malfunction (outdoor)
<i>J8</i>	Liquid temperature sensor (coil) malfunction (outdoor)
<i>J9</i>	Gas temperature sensor (after subcool HE) malfunction (outdoor)
<i>JA</i>	High pressure sensor malfunction (S1NPH)
<i>JC</i>	Low pressure sensor malfunction (S1NPL)
<i>L1</i>	INV PCB abnormal
<i>L4</i>	Fin temperature abnormal
<i>L5</i>	INV PCB abnormal
<i>L8</i>	Compressor over current detected
<i>L9</i>	Compressor lock (startup)
<i>LC</i>	Transmission outdoor unit - inverter: INV transmission trouble
<i>P1</i>	INV unbalanced power supply voltage
<i>P4</i>	Fin thermistor malfunction
<i>PJ</i>	Capacity setting malfunction (outdoor)
<i>U0</i>	Abnormal low pressure drop, faulty expansion valve
<i>U1</i>	Reversed power supply phase malfunction
<i>U2</i>	INV voltage power shortage
<i>U3</i>	System test run not yet executed
<i>U4</i>	Faulty wiring indoor/BS unit/outdoor
<i>U5</i>	Abnormal user interface - indoor communication
<i>U7</i>	Faulty wiring to outdoor/outdoor

Main code	Contents
<i>U9</i>	Warning because there is an error on another unit (indoor/BS unit)
<i>UR</i>	Connection malfunction over indoor units or type mismatch
<i>UR-55</i>	System lock
<i>UR-57</i>	External ventilation input error
<i>UC</i>	Centralised address duplication
<i>UE</i>	Malfunction in communication centralised control device - indoor unit
<i>UF</i>	Faulty wiring indoor/BS unit
<i>UH</i>	Auto address malfunction (inconsistency)

^(a) The error code is only shown on the user interface of the indoor unit where the error occurs.

8.2 Symptoms that are NOT system malfunctions

The following symptoms are NOT system malfunctions:

8.2.1 Symptom: The system does not operate

- The air conditioner does not start immediately after the ON/OFF button on the user interface is pressed. If the operation lamp lights, the system is in normal condition. To prevent overloading of the compressor motor, the air conditioner starts 5 minutes after it is turned ON again in case it was turned OFF just before. The same starting delay occurs after the operation mode selector button was used.
- If "Under Centralised Control" is displayed on the user interface, pressing the operation button causes the display to blink for a few seconds. The blinking display indicates that the user interface cannot be used.
- The system does not start immediately after the power supply is turned on. Wait one minute until the microcomputer is prepared for operation.

8.2.2 Symptom: Fan operation is possible, but cooling and heating do not work

Immediately after the power is turned on. The micro computer is getting ready to operate and is performing a communication check with all indoor units. Please wait 12 minutes maximally until this process is finished.

8.2.3 Symptom: The fan speed does not correspond to the setting

The fan speed does not change even if the fan speed adjustment button is pressed. During heating operation, when the room temperature reaches the set temperature, the outdoor unit goes off and the indoor unit changes to whisper fan speed. This is to prevent cold air blowing directly on occupants of the room. The fan speed will not change even when another indoor unit is in heating operation, if the button is pressed.

8.2.4 Symptom: The fan direction does not correspond to the setting

The fan direction does not correspond with the user interface display. The fan direction does not swing. This is because the unit is being controlled by the micro computer.

8.2.5 Symptom: White mist comes out of a unit (Indoor unit)

- When humidity is high during cooling operation. If the interior of an indoor unit is extremely contaminated, the temperature distribution inside a room becomes uneven. It is necessary to clean the interior of the indoor unit. Ask your dealer for details on cleaning the unit. This operation requires a qualified service person.
- Immediately after the cooling operation stops and if the room temperature and humidity are low. This is because warm refrigerant gas flows back into the indoor unit and generates steam.

8.2.6 Symptom: White mist comes out of a unit (Indoor unit, outdoor unit)

When the system is changed over to heating operation after defrost operation. Moisture generated by defrost becomes steam and is exhausted.

8.2.7 Symptom: The user interface reads "U4" or "U5" and stops, but then restarts after a few minutes

This is because the user interface is intercepting noise from electric appliances other than the air conditioner. The noise prevents communication between the units, causing them to stop. Operation automatically restarts when the noise ceases. A power reset may help to remove this error.

8.2.8 Symptom: Noise of air conditioners (Indoor unit)

- A "zeen" sound is heard immediately after the power supply is turned on. The electronic expansion valve inside an indoor unit starts working and makes the noise. Its volume will reduce in about one minute.
- A continuous low "shah" sound is heard when the system is in cooling operation or at a stop. When the drain pump (optional accessories) is in operation, this noise is heard.
- A "pishi-pishi" squeaking sound is heard when the system stops after heating operation. Expansion and contraction of plastic parts caused by temperature change make this noise.
- A low "sah", "choro-choro" sound is heard while the indoor unit is stopped. When another indoor unit is in operation, this noise is heard. In order to prevent oil and refrigerant from remaining in the system, a small amount of refrigerant is kept flowing.

8.2.9 Symptom: Noise of air conditioners (Indoor unit, outdoor unit)

- A continuous low hissing sound is heard when the system is in cooling or defrost operation. This is the sound of refrigerant gas flowing through both indoor and outdoor units.
- A hissing sound which is heard at the start or immediately after stopping operation or defrost operation. This is the noise of refrigerant caused by flow stop or flow change.

8.2.10 Symptom: Noise of air conditioners (Outdoor unit)

When the tone of operating noise changes. This noise is caused by the change of frequency.

8.2.11 Symptom: Dust comes out of the unit

When the unit is used for the first time in a long time. This is because dust has gotten into the unit.

8.2.12 Symptom: The units can give off odours

The unit can absorb the smell of rooms, furniture, cigarettes, etc., and then emit it again.

8.2.13 Symptom: The outdoor unit fan does not spin

During operation. The speed of the fan is controlled in order to optimise product operation.

8.2.14 Symptom: The display shows "88"

This is the case immediately after the main power supply switch is turned on and means that the user interface is in normal condition. This continues for 1 minute.

8.2.15 Symptom: The compressor in the outdoor unit does not stop after a short heating operation

This is to prevent refrigerant from remaining in the compressor. The unit will stop after 5 to 10 minutes.

8.2.16 Symptom: The inside of an outdoor unit is warm even when the unit has stopped

This is because the crankcase heater is warming the compressor so that the compressor can start smoothly.

8.2.17 Symptom: Hot air can be felt when the indoor unit is stopped

Several different indoor units are being run on the same system. When another unit is running, some refrigerant will still flow through the unit.

9 Relocation

Contact your dealer to remove and reinstall the entire unit. Moving units requires technical expertise.

10 Disposal

This unit uses hydrofluorocarbon. Contact your dealer when discarding this unit. It is required by law to collect, transport and discard the refrigerant in accordance with the "hydrofluorocarbon collection and destruction" regulations.

**NOTICE**

Do NOT try to dismantle the system yourself: dismantling of the system, treatment of the refrigerant, oil and other parts MUST comply with applicable legislation. Units MUST be treated at a specialised treatment facility for reuse, recycling and recovery.

For the installer

11 About the box

Keep the following in mind:

- At delivery, the unit **MUST** be checked for damage and completeness. Any damage or missing parts **MUST** be reported immediately to the claims agent of the carrier.
- Bring the packed unit as close as possible to its final installation position to prevent damage during transport.
- Prepare in advance the path along which you want to bring the unit to its final installation position.



11.1 To remove the accessories from the outdoor unit

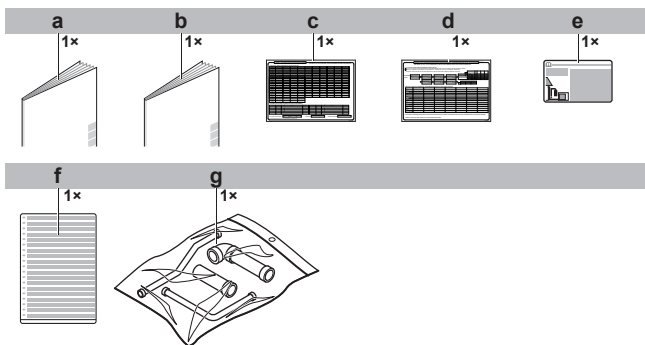

Make sure that all accessories are available in the unit.

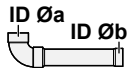
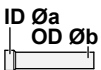
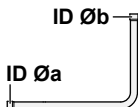

- a General safety precautions
- b Installation manual and operation manual
- c Additional refrigerant charge label
- d Installation information sticker
- e Fluorinated greenhouse gases label
- f Multilingual fluorinated greenhouse gases label
- g Piping accessory bag

11.2 Accessory pipes: Diameters

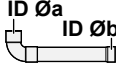
Accessory pipes	HP	Øa [mm]	Øb [mm]
Gas pipe • Front connection  • Bottom connection 	5	25.4	19.1
	8		
	10		
	12		22.2
	14		
	16		
	18		
20	28.6		
Liquid pipe • Front connection  • Bottom connection 	5	9.5	9.5
	8		
	10		
	12		12.7
	14		
	16		
	18		
20			

Accessory pipes	HP	Øa [mm]	Øb [mm]
High pressure/low pressure gas pipe • Front connection  • Bottom connection 	5	19.1	15.9
	8		
	10		
	12		19.1
	14		
	16		
	18		
20	22.2		

11.3 To remove the transportation stay (only for 5~12 HP)



NOTICE

If the unit is operated with the transportation stay attached, abnormal vibration or noise may be generated.

The transportation stay for protecting the unit during transport must be removed. Proceed as shown in the figure and procedure below.

- 1 Remove the bolt (a) and washers.
- 2 Remove the transportation stay (b) as shown in the figure below.

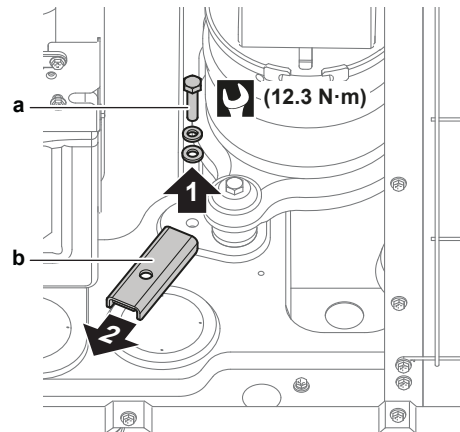

- a Bolt
- b Transportation stay

12 About the units and options

12.1 About the outdoor unit

This installation manual concerns the VRV 5, full inverter driven, heat recovery system.

Model line up:

Model	Description
REYA8~20	Heat recovery model for single or multi-use
REMA5	Heat recovery model for multi-use only

Depending on the type of outdoor unit which is chosen, some functionality will or will not exist. It will be indicated throughout this installation manual and brought to your attention. Certain features have exclusive model rights.

These units are intended for outdoor installation and aimed for heat pump applications including air to air applications.

These units have (in single use) heating capacities ranging from 25 to 63 kW and cooling capacities rating from 22.4 to 56 kW. In multi combination the heating capacity can go up to 90 kW and in cooling to 80 kW.

The outdoor unit is designed to work in heating mode at ambient temperatures from -20°C WB to 15.5°C WB and in cooling mode at ambient temperatures from -5°C DB to 46°C DB.

12.2 System layout



WARNING

The installation **MUST** comply with the requirements that apply to this R32 equipment. For more information, see "13 Special requirements for R32 units" [▶ 17].



INFORMATION

The following figure is an example and may NOT completely match your system layout

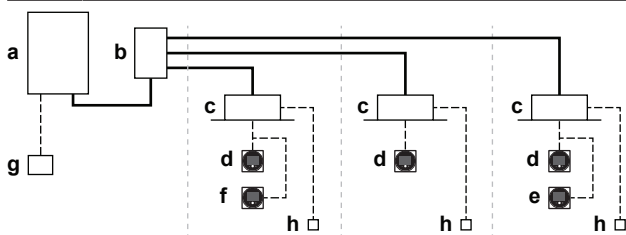

- a Heat recovery outdoor unit
- b Branch selector (BS)
- c VRV direct expansion (DX) indoor unit
- d Remote controller in **normal mode**
- e Remote controller in **alarm only mode**
- f Remote controller in **supervisor mode** (mandatory in some situations)
- g Centralised controller (optional)
- h Option PCB (optional)
- Refrigerant piping
- Interconnection and user interface wiring

13 Special requirements for R32 units

13.1 Installation space requirements



WARNING

If the appliance contains R32 refrigerant, the floor area of the room in which the appliance is stored shall be at least 956 m².



NOTICE

- Protect the pipework from physical damage.
- Make sure the pipework is securely mounted.
- Keep the pipework installation to a minimum.

13.2 System layout requirements

The VRV 5 uses R32 refrigerant which is rated as A2L and is mildly flammable.

To comply with the requirements of enhanced tightness refrigerating systems of the IEC 60335-2-40, this system is equipped with shut-off valves in the BS unit and an alarm in the remote controller. The BS unit is prearranged for a ventilated enclosure as countermeasure. In case the requirements of this manual are followed, no additional safety measures are needed.

A big range of charge and room area combinations is allowed thanks to the countermeasures that are implemented in the system by default.

Follow the installation requirements below to ensure that the complete system is compliant to legislation.

Outdoor unit installation

The outdoor unit must be installed outside. For indoor installation of the outdoor unit, additional measures can be necessary to comply with the applicable legislation.

A terminal for external output is available in the outdoor unit. This SVS output can be used when additional countermeasures are needed. The SVS output is a contact on terminal X2M that closes in case a leak is detected, failure or disconnection of an R32 sensor (located in the indoor unit or BS unit).

For more information about the SVS output, see "17.8 To connect the external outputs" [▶ 39].

Indoor unit installation



NOTICE

If one or more rooms are connected to the unit using a duct system, make sure air inlet AND outlet are connected directly to the same room by ducting. Do NOT use spaces such as a false ceiling as a duct for the air inlet or outlet.

For installation of the indoor unit, refer to the installation and operation manual delivered with the indoor unit. For compatibility of indoor units refer to the latest version of the technical data book of this unit.

The total amount of refrigerant in the system shall be less than or equal to the maximum allowed total refrigerant amount. The maximum allowed total refrigerant amount depends on the area of the rooms being served by the system and the rooms in the lowest underground floor.

See "13.4 To determine the charge limit" [▶ 20] to check if your system meets the requirement for charge limitation.

An optional output PCB for the indoor unit can be added to provide output for external device. The output PCB will trigger in case a leak is detected, the R32 sensor fails or when the sensor is disconnected. For exact model name see option list of the indoor unit. For more information about this option, refer to the installation manual of the optional output PCB.

BS unit installation

Depending on the room size in which the BS unit is installed and the total amount of refrigerant in the system, different safety measures can be applied: alarm or ventilated enclosure.

For more information refer to the installation manual delivered with the BS unit.

Piping requirements

Piping must be installed according to instructions given in "15 Piping installation" [▶ 25]. Only mechanical joints (e.g. braze+flare connections) that are compliant with the latest version of ISO14903 can be used.

For piping installed in the occupied space, please make sure that the piping is protected against accidental damage. Piping should be checked according to the procedure as mentioned in "15.3 Checking the refrigerant piping" [▶ 29].

Remote controller requirements



INFORMATION

The following figure is an example and may NOT completely match your system layout

13 Special requirements for R32 units

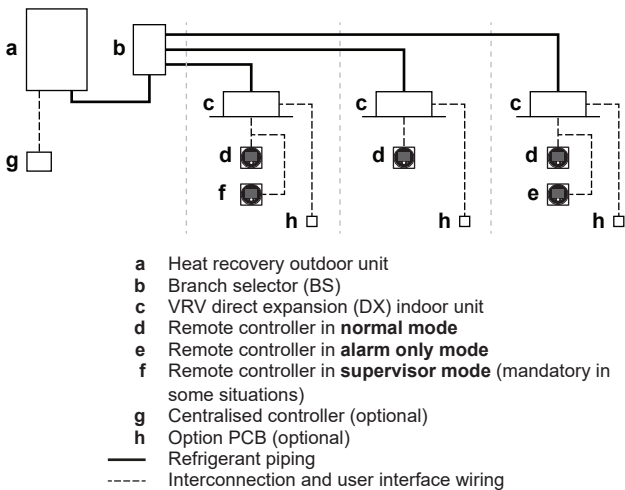

For installation of the remote controller, please refer to the installation and operation manual delivered with the remote controller. Each indoor unit must be connected with a R32 safety system compatible remote controller (e.g. BRC1H52/82* or later type). These remote controllers have implemented safety measures that will warn the user visually and audibly in case of a leak.

For installation of the remote controller, it is mandatory to follow the requirements.

- 1 Only a safety system compatible remote controller can be used. See technical data sheet for remote controller compatibility (e.g. BRC1H52/82*).
- 2 Each indoor unit must be connected to a separate remote controller. In case indoor units are operating under group control, it is possible to only use one remote controller per room.
- 3 The remote controller put in the room served by the indoor unit must be in 'fully functional' or 'alarm only' mode. In case the indoor unit is serving a different room than where it is installed, a remote controller is required in both installed and served room. For details about the different remote controller modes and how to set up, please check the note below or refer to the installation and operation manual delivered with the remote controller.
- 4 For buildings where sleeping facilities are offered (e.g. hotel), where persons are restricted in their movements (e.g. hospitals), an uncontrolled number of persons is present or buildings where people are not aware of the safety precautions it is mandatory to install one of the following devices at a location with 24-hour monitoring:
 - a supervisor remote controller
 - or a centralised controller. E.g., iTM with external alarm via WAGO module, iTM with built-in alarm, ...

Note: The remote controllers with built-in alarm will generate a visible and audible warning. E.g. the BRC1H52/82* remote controllers can generate an alarm of 65 dB (sound pressure,

measured at 1 m distance of the alarm). Sound data is available in the technical data sheet of the remote controller. **The alarm should always be 15 dB louder than the background noise of the room.**

A field supply external alarm with a sound output 15 dB louder than the background noise of the room **MUST** be installed in the following cases:

- The sound output of the remote controller is not sufficient to guarantee the 15 dB difference. This alarm can be connected to the SVS output channel of the outdoor unit or the BS unit, or to the optional output PCB of the indoor unit of that specific room. The outdoor SVS will trigger for any R32 leak detected in the complete system. For BS units and indoor units, SVS is only triggered when its own R32 sensor detects a leak. For more information on the SVS output signal, see ["17.8 To connect the external outputs"](#) [▶ 39].
- A centralised controller without built-in alarm is used, or the sound output of the centralised controller with built-in alarm is not sufficient to guarantee the 15 dB difference. Please refer to the installation manual of the centralised controller for the correct procedure to install the external alarm.

Note: Depending on configuration, the remote controller is operable in three possible modes. Each mode offers different controller functionality. For detailed information about setting the operation mode of the remote controller and its function, please refer to the installer and user reference guide of the remote controller.

Mode	Function
Fully functional	The controller is fully functional. All normal functionality is available. This controller can be master or slave.
Alarm only	The controller only acts as leak detection alarm (for a single indoor unit). No functionality is available. The remote controller should always be put in the same room as the indoor unit. This controller can be master or slave.
Supervisor	The controller only acts as leak detection alarm (for the whole system, i.e. multiple indoor units and their respective controllers). No other functionality is available. The remote controller should be placed at a supervised location. This remote controller can only be the slave. Note: In order to add a supervisor remote controller to the system, a field setting must be set on remote controller and outdoor unit. Indoor units and BS units need to be assigned an address number.

Note: Incorrect use of remote controllers can result in occurrence of error codes, non-operating system or system that is not compliant to applicable legislation.

Note: Some centralised controllers can also be used as supervisor remote controller. For further details on installation, please refer to the installation manual of the centralised controllers.

Examples

	NOT OK	OK	Case
1			Remote controller is not R32 safety system compatible

13 Special requirements for R32 units

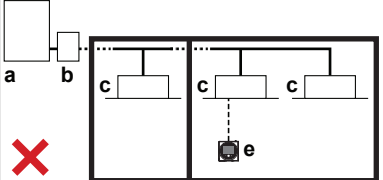
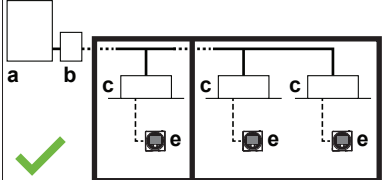
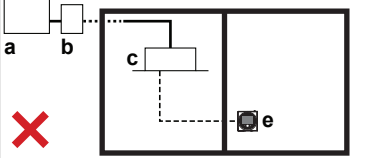
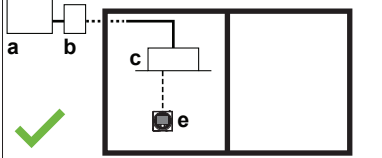
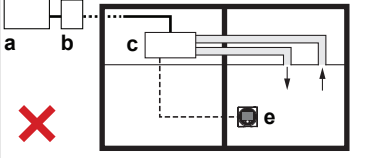
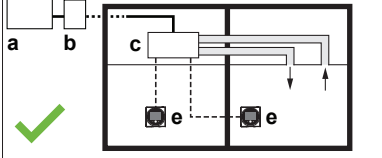
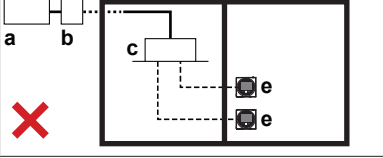
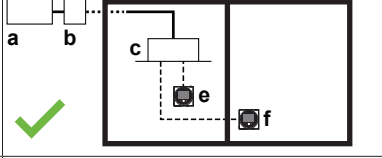
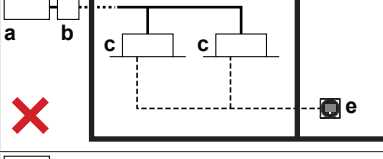
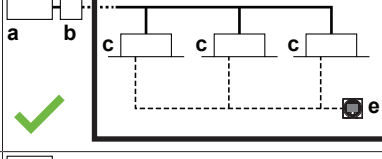
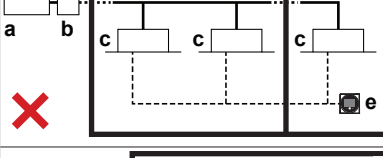
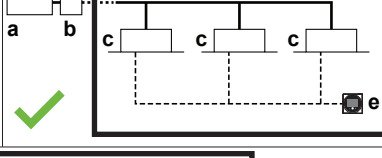
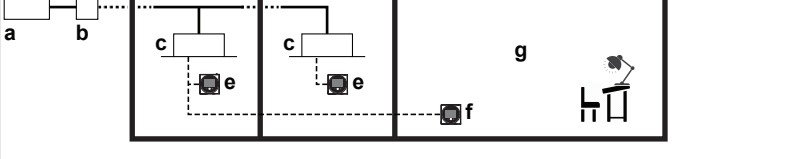
	NOT OK	OK	Case
2			Indoor units without remote controller are not allowed
3			In case of one R32 safety system compatible remote controller, it should be the master and in the same room of the indoor unit.
4			In case a ducted indoor unit is serving a different room than where it is installed, both supply and return air MUST be directly ducted to that room. The room area and remote controller rules MUST be followed for both installed and served room.
5			In case of two R32 safety system compatible remote controllers, at least one remote controller should be in the room of the indoor.
6			Group control is allowed up to a maximum of 5 indoor units connected to different ports or connected to the same port. At least one R32 safety system compatible remote controller should be in the room of the indoors.
7			All indoor units under group control need to be conditioning the same room.
8			In particular situations it is mandatory to install a remote controller at a supervised location
	<p>In room: master remote controller in fully functional OR alarm only. In supervisor room: supervisor remote controller</p>		

- a Outdoor unit
- b BS unit
- c Indoor unit
- d Remote controller NOT compatible with R32 safety system

- e Remote controller compatible with R32 safety system
- f Remote controller in supervisor mode
- g Supervisor room

13.3 About the charge limit

The charge limit must be determined separately for **each BS unit branch pipe port**.

This is possible because of the shut-off valves in the BS unit. The maximum amount of refrigerant that can escape in case of a leak is determined by the piping length and indoor heat exchanger size. This is directly linked to the downstream indoor unit capacity of this piping section.

13 Special requirements for R32 units

In case a leak is detected in an indoor unit, the shut-off valves in the BS unit of the respective port will close. The piping section with the leak is now shut off from the rest of the system and the amount of refrigerant that can leak is significantly reduced.

Note: When two branch pipe ports are combined in order to form a single branch pipe port (e.g. FXMA200/250), they must be considered as a single branch pipe port.

13.4 To determine the charge limit

Step 1 – In order to derive the total refrigerant charge limit in the system, determine the area

- of the rooms where an indoor unit is installed,
- AND of the area of the rooms served by a ducted indoor unit installed in a different room.

The room area can be determined by projecting the walls, doors and partitions to the floor and calculate the enclosed area. The area of the smallest room being served by a port of the BS unit is used in the next step to determine the maximum allowable indoor capacity that can be connected to that port.

Spaces connected by only false ceilings, ductwork, or similar connections shall not be considered a single space.

If the partition between two rooms on the same floor meets certain requirements then the rooms are considered as one room and the areas of the rooms may be added up. In this way it is possible to increase the $A_{n\min}$ value used to calculate the maximum allowed charge.

One of the following two requirements must be met in order to add up room areas:

- Rooms on the same floor that are connected with a permanent opening that extends to the floor and is intended for people to walk through can be considered as one room.
- Rooms on the same floor connected with openings that fulfil following requirements can be considered as a single room. The opening must consist out of two parts to allow for air circulation.

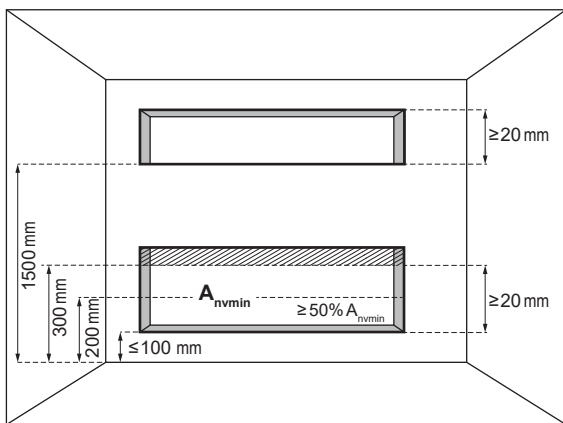

$A_{n\min}$ Minimal natural ventilation area

For the lower opening:

- It is not an opening to the outside
- The opening cannot be closed
- The opening must be $\geq 0.012 \text{ m}^2$ ($A_{n\min}$)
- The area of any openings above 300 mm from the floor does not count when determining $A_{n\min}$
- At least 50% of $A_{n\min}$ is less than 200 mm above the floor
- The bottom of the lower opening is $\leq 100 \text{ mm}$ from the floor
- The height of the opening is $\geq 20 \text{ mm}$

For the upper opening:

- It is not an opening to the outside
- The opening cannot be closed
- The opening must be $\geq 0.006 \text{ m}^2$ (50% of $A_{n\min}$)
- The bottom of the upper opening must be $\geq 1500 \text{ mm}$ above the floor
- The height of the opening is $\geq 20 \text{ mm}$

Note: The requirement for the upper opening can be met by false ceilings, ventilation ducts or similar arrangements that provide an airflow path between the connected rooms.



NOTICE

Indoor units and the bottom of duct openings cannot be installed lower than 1.8 m from the lowest point of the floor.

Step 2 – Use the table below to determine the maximum total indoor unit capacity (sum of all connected indoor units) that is allowed for a single BS unit branch pipe port. In case a ducted indoor unit is serving a different room than where it is installed, the restrictions of the room area apply to both the indoor installation room as the conditioned room separately. Supply and return air shall be directly ducted to that room.

Area of installed/conditioned room [m ²]	Maximum total indoor unit capacity class		
	1 indoor unit per branch pipe port ^(a)	2~5 indoor units per branch pipe port	
		40 m after 1 st branch ^(b)	90 m after 1 st branch ^(c)
≤6	—	—	—
7	10	—	—
8	15	—	—
9	32	—	—
10	32	—	—
11	40	—	—
12	40	—	—
13	71	—	—
14	80	—	—
15	80	—	—
20	80	32	—
25	140	40	25
30	200	63	50
35	200	71	71
40	250	100	100
≥45	250	140	140

^(a) One indoor unit connected to a single branch pipe port.

^(b) Two to five indoor units connected to a single branch pipe port, 40 m after first refrigerant branch.

^(c) Two to five indoor units connected to a single branch pipe port, 90 m after first refrigerant branch (size-up of liquid pipe, see "15.1 Preparing refrigerant piping" [25]).

Notes:

- The values in the table are under the assumption of worst case indoor unit volume and 40 m piping between indoor and BS unit and an installation height between 1.8 m and 2.2 m (bottom of indoor unit or bottom of duct openings). In [VRV Xpress](#) it is possible to add custom piping lengths, installation heights above 2.2 m and custom indoor units which can lead to lower minimum room area requirements.
- In case multiple indoor units are connected to the same branch pipe port, the sum of the connected indoor unit capacity classes needs to be equal or less than the value indicated in the table.

13 Special requirements for R32 units

- In case indoor units connected to the same branch pipe port are split over different rooms, the area of the smallest room needs to be considered.
- Round down the derived values.

Step 3 – In case there are any indoor units installed on the lowest underground floor in the building, there is an extra requirement for the maximum allowable charge: the installed/served room that has the smallest area on the lowest underground floor determines the maximum allowable charge of the entire system. Use the graph or table (see "Figure 1" ▶ 2] at the beginning of this manual) to determine the total refrigerant charge limit in the system.

Note: Round down the derived values.

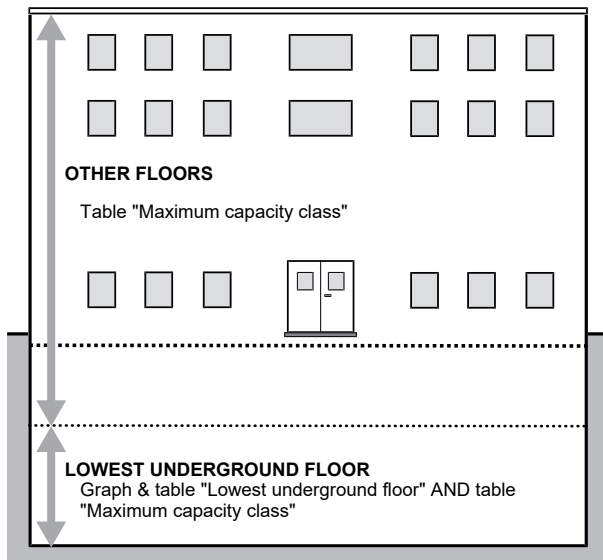

- m** Total refrigerant charge limit in the system
- A_{min}** Smallest room area
- (a)** Lowest underground floor (=Lowest underground floor)

Step 4 – Use the values on the unit nameplate to determine the total amount of refrigerant in the system.

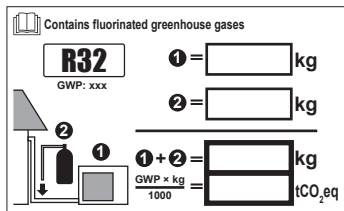

Total charge=Factory charge ①^(a)+additional charge ②^(b)

- ^(a) The factory charge value can be found on the nameplate.
- ^(b) The R value is calculated in "16.3 To determine the additional refrigerant amount" ▶ 32].

Step 5 – The total indoor capacity connected to a branch pipe port (or pair of branch pipe ports in case of FXMA200/250) **MUST** be equal or less than the capacity limit that is derived from the table. Additionally, in case an indoor unit is installed in the lowest underground floor, the total charge of the system **MUST** be less than the limit that is derived from the graph. If NOT, change the installation and repeat all of the above steps.

Possible changes:

- Increase the area of smallest room (installed & conditioned) connected to the same branch pipe port.
- Reduce the indoor capacity connected to the same branch pipe port to equal or below the limit.
- Add additional countermeasures as described in applicable legislation. SVS output or optional output PCB for indoor unit can be used to connect and activate the additional countermeasures (e.g. mechanical ventilation). For more information, see "17.8 To connect the external outputs" ▶ 39].
- Split indoor capacity over two separate branch pipe ports.
- Fine tune system with more detailed calculations in [VRV Xpress](#).



NOTICE

The total refrigerant charge amount in the system **MUST** always be lower than 15.96 [kg] × the number of indoor units connected downstream of BS units, with a maximum of 63.8 kg.

Example 1

VRV system serving three rooms via one BS unit. Room 1 (20 m²) is served by one indoor unit (32 class) connected to port **A**. Room 2 (42 m²) is served by two indoor units (2×50 class) connected to port **B** (no extension and liquid pipe size up has been done). Room 3 (150 m²) is served by one indoor unit (200 class) connected to ports **C** and **D**.

Port **A** is connected to an indoor unit installed in room 1a, that is serving a different room (room 1b) than where it is installed. The smallest room size needs to be considered: 20 m². Use the table under **Step 2** to find the maximum capacity class of the indoor unit: 80. The selected indoor unit is 32 → **OK**.

Port **B** only serves room 2: use the table under **Step 2** to find the maximum capacity class of the sum of the indoor units. 42 m² is rounded down to 40 m²: 100. The sum of both indoor units is exactly 100 → **OK**.

Ports **C** and **D** are combined and have to be considered as one branch pipe. They only serve room 3: Use the table under **Step 2** to find the maximum capacity class of the indoor unit: 250. The selected indoor unit is 200 → **OK**.

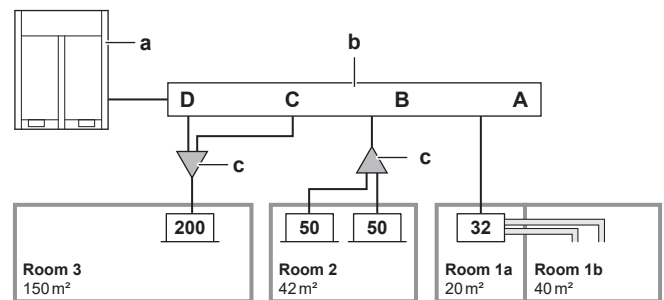

- A~D** Branch pipe port A~D
- a** Outdoor unit
- b** BS unit
- c** Indoor branch kit (refnet)
- Room** Room
- 32/50/200** Indoor unit capacity

Example 2

VRV system serving three rooms via one BS unit. Room 1 (40 m², one level underground) is served by one indoor unit (32 class) connected to port **A**. Room 2 (60 m², ground level) is served by two indoor units (1×20 and 1× 40 class) also connected to port **A** (no extension and liquid pipe size up has been done).

Room 3 (60 m², 2 levels underground) is served by one indoor unit (63 class) and is connected to port **C**.

13 Special requirements for R32 units

Port **A** serves room 1 and 2: use the table under **Step 2**: the smallest room determines the maximum sum of capacity classes. For port **A** this is room 1 → 100. 32+20+40=92 → **OK**.

Port **C** serves only room 3: use the table under **Step 2** to find the maximum capacity class of the indoor unit: 250. The selected indoor unit is 63 → **OK**.

The building only has two underground floor levels, where room 3 is located on the lowest underground level. Maximum charge limit for the complete system is determined using the graph for lowest underground floor: 20.2 kg.

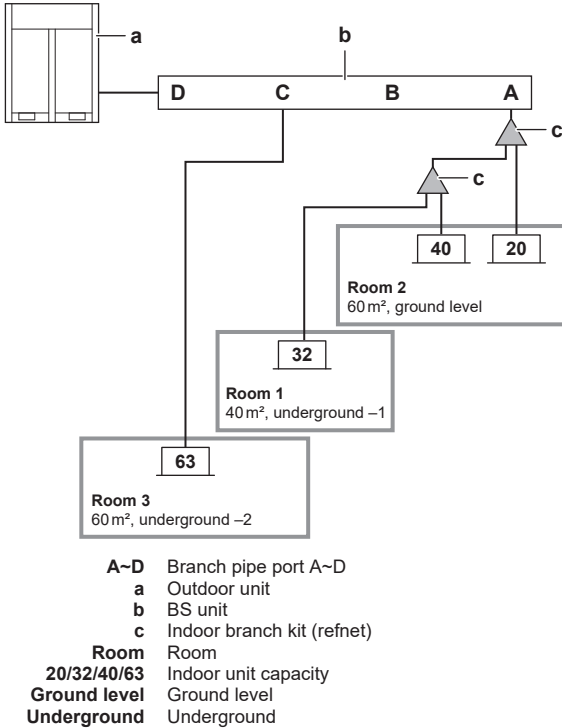

Flow chart (for EACH BS unit branch pipe port)

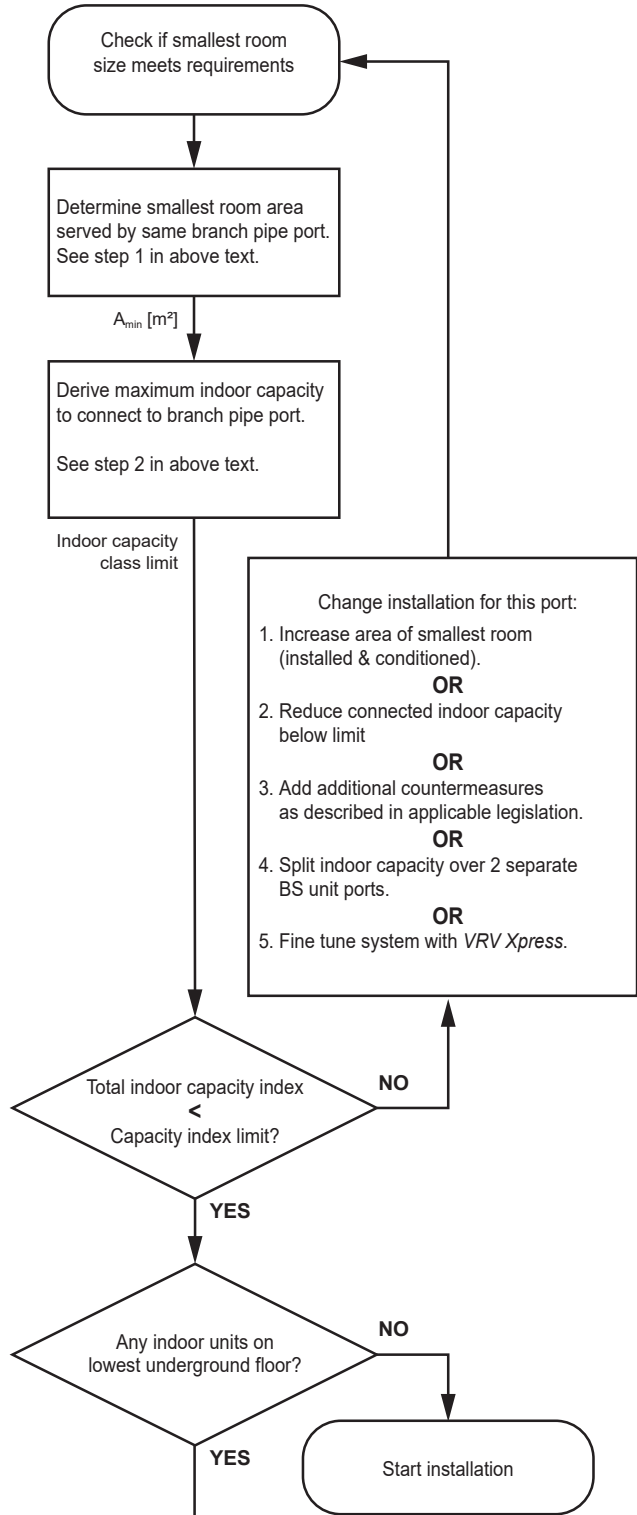

Continued on next column/page

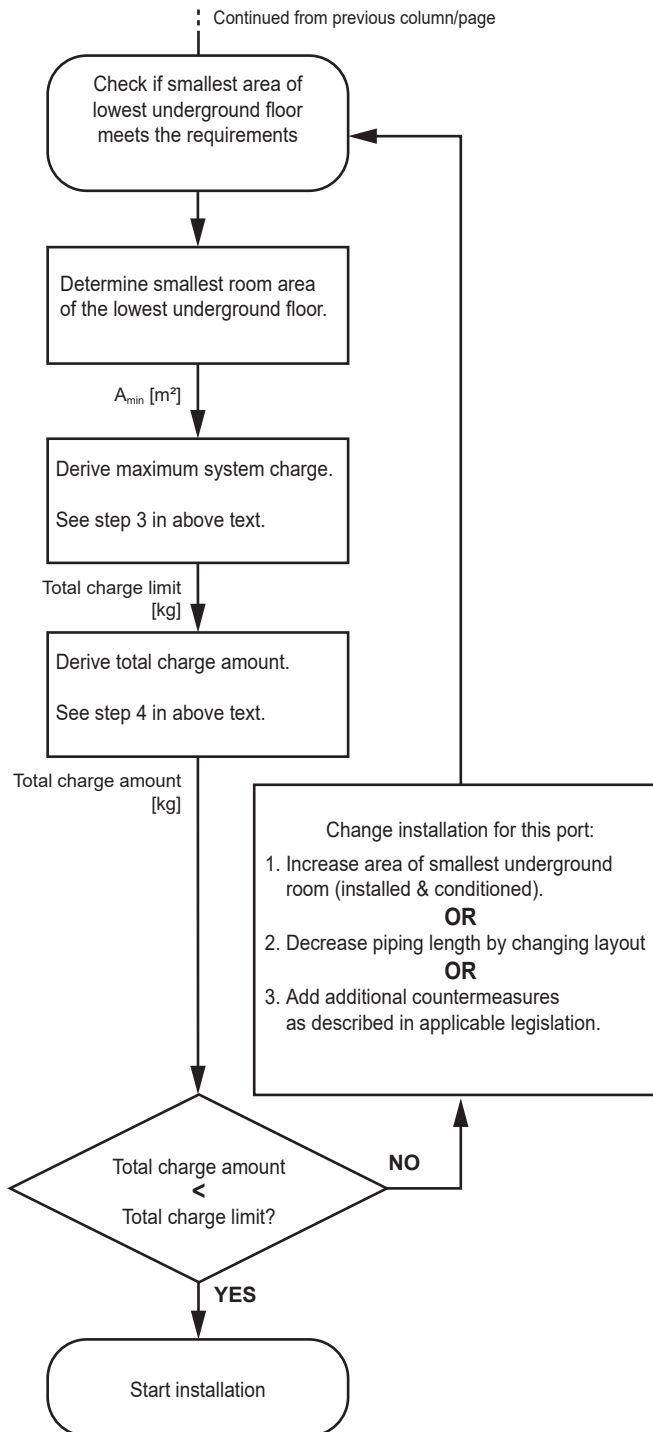

WARNING

The appliance shall be stored as follows:

- in such a way as to prevent mechanical damage.
- in a well-ventilated room without continuously operating ignition sources (example: open flames, an operating gas appliance or an operating electric heater).
- in a room with dimensions as specified in "13 Special requirements for R32 units" [▶ 17].

14.1.1 Installation site requirements of the outdoor unit

Mind the spacing guidelines. See the "Technical data" chapter.



INFORMATION

Equipment meets the requirement for commercial and light-industrial location when professionally installed and maintained.



INFORMATION

The sound pressure level is less than 70 dBA.



CAUTION

Appliance NOT accessible to the general public, install it in a secured area, protected from easy access.

This unit, both indoor and outdoor, is suitable for installation in a commercial and light industrial environment.



CAUTION

This equipment is NOT intended for use in residential locations and will NOT guarantee to provide adequate protection to radio reception in such locations.



NOTICE

If the equipment is installed closer than 30 m to a residential location, the professional installer MUST evaluate the EMC situation before installation.



NOTICE

The installation and any maintenance requires a professional with relevant EMC experience to install any specific EMC mitigation measures defined in the user instructions.

14 Unit installation



WARNING

The installation MUST comply with the requirements that apply to this R32 equipment. For more information, see "13 Special requirements for R32 units" [▶ 17].

14.1 Preparing the installation site



WARNING

The appliance shall be stored in a room without continuously operating ignition sources (example: open flames, an operating gas appliance or an operating electric heater).

14 Unit installation

14.1.2 Additional installation site requirements of the outdoor unit in cold climates

NOTICE

When operating the unit in a low outdoor ambient temperature with high humidity conditions, make sure to take precautions to keep the drain holes of the unit free by using proper equipment.

In heating:

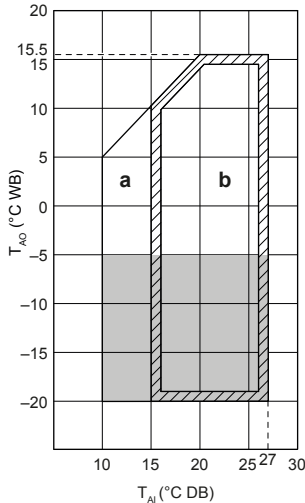

a Warming up operation range

b Operation range

T_{Ai} Ambient indoor temperature

T_{Ao} Ambient outdoor temperature

■ If the unit has to operate for 5 days in this area with high humidity (>90%), Daikin recommends to install the optional heater tape kit (EKBPH012TA or EKBPH020TA) to keep the drain holes free.

14.2 Opening the unit

14.2.1 To open the outdoor unit

DANGER: RISK OF ELECTROCUTION

DANGER: RISK OF BURNING/SCALDING

5~12 HP

14~20 HP

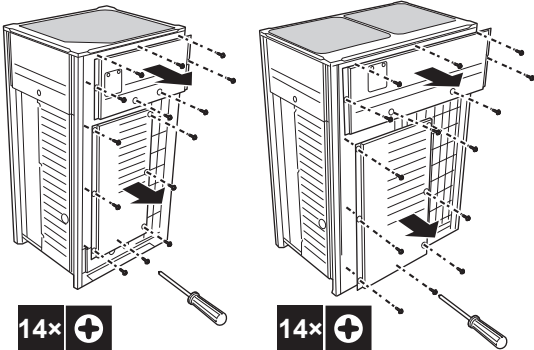

Once the front plates open, the electrical component box can be accessed. See "14.2.2 To open the electrical component box of the outdoor unit" [p. 24].

For service purposes, the pushbuttons on the main PCB need to be accessed. To access these pushbuttons, the electrical component box cover does not need to be opened. See "18.1.3 To access the field setting components" [p. 41].

14.2.2 To open the electrical component box of the outdoor unit

NOTICE

Do NOT apply excessive force when opening the electronic component box cover. Excessive force can deform the cover, resulting in entering of water to cause equipment failure.

5~12 HP

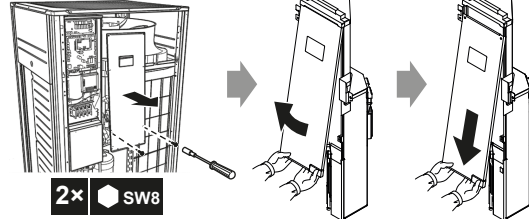

14~20 HP

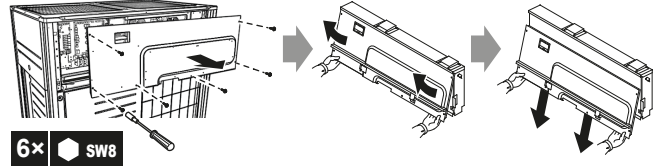

NOTICE

When closing the electrical component box cover, make sure that the sealing material on the lower back side of the cover is NOT caught and bent towards the inside (see figure below).

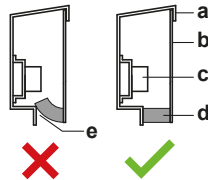

- a Electrical component box cover
- b Front side
- c Power supply terminal block
- d Sealing material
- e Moisture and dirt could enter
- ✗ NOT allowed
- ✓ Allowed

14.3 Mounting the outdoor unit

14.3.1 To provide the installation structure

Make sure the unit is installed level on a sufficiently strong base to prevent vibration and noise.

NOTICE

- When the installation height of the unit needs to be increased, do NOT use stands to only support the corners.
- Stands under the unit must be at least 100 mm wide.

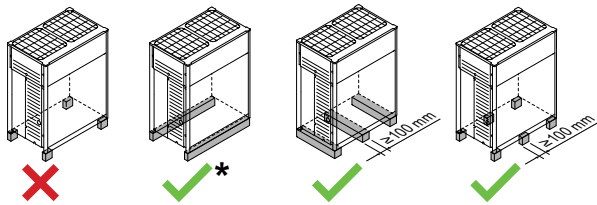

✗ NOT allowed
 ✓ Allowed (* = preferred installation)

- The height of the foundation must at least be 150 mm from the floor. In heavy snowfall areas, this height should be increased, depending on the installation place and condition.
- The preferred installation is on a solid longitudinal foundation (steel beam frame or concrete). The foundation must be larger than the grey marked area.

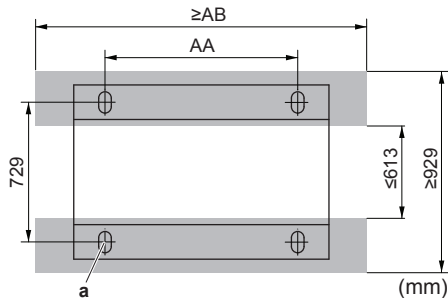

■ Minimum foundation
 a Anchor point (4×)

HP	AA	AB
5~12	766	992
14~20	1076	1302

- Fasten the unit in place using four foundation bolts M12. It is best to screw in the foundation bolts until their length remains 20 mm above the foundation surface.

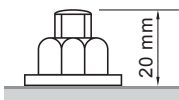

NOTICE

- Prepare a water drainage channel around the foundation to drain waste water from around the unit. During heating operation and when the outdoor temperatures are negative, the drained water from the outdoor unit will freeze up. If the water drainage is not taken care of, the area around the unit might be very slippery.
- When installed in a corrosive environment, use a nut with plastic washer (a) to protect the nut tightening part from rust.

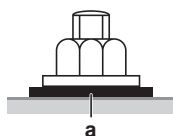

14.3.2 To install the outdoor unit

- 1 Transport the unit by crane or forklift and put it onto the installation structure.
- 2 Fix the unit to the installation structure.
- 3 If transported by crane, remove the slings.

15 Piping installation

CAUTION

See "2 Specific installer safety instructions" [▶ 4] to make sure this installation complies with all safety regulations.

15.1 Preparing refrigerant piping

15.1.1 Refrigerant piping requirements

NOTICE

The piping and other pressure-containing parts shall be suitable for refrigerant. Use phosphoric acid deoxidised seamless copper for refrigerant piping.

- Foreign materials inside pipes (including oils for fabrication) must be ≤30 mg/10 m.

15.1.2 Refrigerant piping material

- **Piping material:** phosphoric acid deoxidised seamless copper
- **Flare connections:** Only use annealed material.
- **Piping temper grade and thickness:**

Outer diameter (Ø)	Temper grade	Thickness (t) ^(a)	
6.4 mm (1/4")	Annealed (O)	≥0.80 mm	
9.5 mm (3/8")			
12.7 mm (1/2")			
15.9 mm (5/8")	Annealed (O)	≥0.99 mm	
19.1 mm (3/4")	Half hard (1/2H)	≥0.80 mm	
22.2 mm (7/8")			
28.6 mm (1 1/8")	Half hard (1/2H)	≥0.99 mm	

^(a) Depending on the applicable legislation and the maximum working pressure of the unit (see "PS High" on the unit name plate), larger piping thickness might be required.

15.1.3 To select the piping size

Determine the proper size using the following tables and reference figure (only for indication).

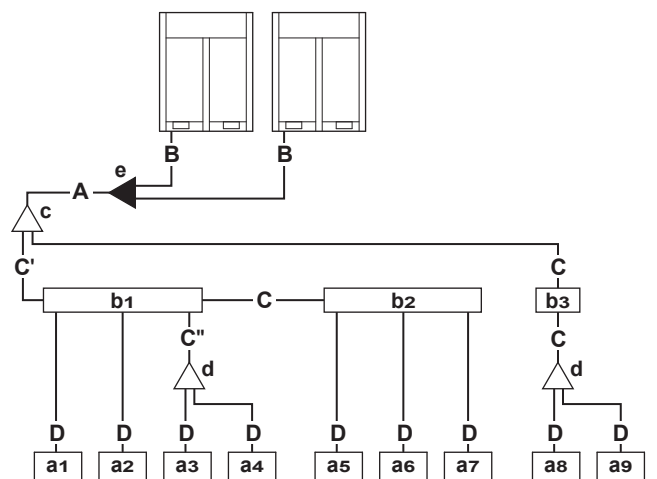

a1~a9 VRV DX indoor units
 b1~b3 BS units
 c First indoor branch kit (refnet)
 d Indoor branch kit (refnet)
 e Outdoor multi connection kit
 A~D Piping

15 Piping installation

A, B: Piping between outdoor unit and (first) refrigerant branch kit

Choose from the following table in accordance with the outdoor unit total capacity type. Pipe A is in case of multi-connection the sum of the outdoor units connected upstream. In case there is no first indoor branch kit (c), pipe A is connected to the first BS unit.

HP class	Piping outer diameter [mm]		
	Liquid pipe	Suction gas pipe	HP/LP gas pipe
5~10	9.5	19.1	15.9
12~18	12.7	22.2	19.1
20~24	12.7	28.6	22.2
26~28	15.9	28.6	22.2

C: Piping between refrigerant branch kits, BS units, or refrigerant branch kits and BS units

Choose from the following table in accordance with the indoor unit total capacity type, connected downstream. Do not let the connection piping exceed the refrigerant piping size chosen by the general system model name.

Example:

- Downstream capacity for C' = [capacity index of unit a1] + [unit a2] + [unit a3] + [unit a4] + [unit a5] + [unit a6] + [unit a7]
- Downstream capacity for C" = [capacity index of unit a3] + [unit a4]

Indoor unit capacity index	Piping outer diameter [mm]		
	Liquid pipe	Suction gas pipe	HP/LP gas pipe
<150	9.5	15.9	12.7
150≤x<290		19.1	15.9
290≤x<450	12.7	22.2	19.1
450≤x<620		28.6	22.2
≥620	15.9		

D: Piping between refrigerant branch kit or BS unit and indoor unit

Pipe size for direct connection to indoor unit must be the same as the connection size of the indoor unit (in case indoor unit is VRV DX indoor).

Indoor unit capacity index	Piping outer diameter [mm]	
	Gas pipe	Liquid pipe
10~32	9.5	6.4
40~80	12.7	
100~140	15.9	9.5
200~250	19.1	

- If a size-up of the piping is required, refer to the table below.

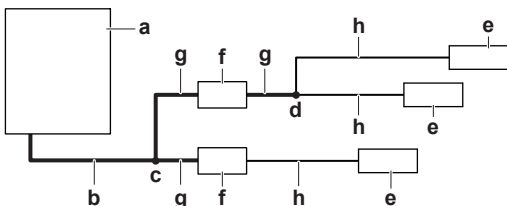

- a Outdoor unit
- b Main pipes (increase size)
- c First refrigerant branch kit
- d Last refrigerant branch kit
- e Indoor unit
- f BS unit
- g Piping between first and last refrigerant branch kit (increase size)

h Piping between last refrigerant branch kit and indoor unit

Size up	
HP class	Liquid piping outer diameter [mm]
5~10	9.5 → 12.7
12~24	12.7 → 15.9
26~28	15.9 → 19.1

- In case the required pipe sizes (inch sizes) are not available, it is also allowed to use other diameters (mm sizes), taken the following into account:
 - Select the pipe size nearest to the required size.
 - Use the suitable adapters for the change-over from inch to mm pipes (field supply).
 - The additional refrigerant calculation has to be adjusted as mentioned in "16.3 To determine the additional refrigerant amount" [p. 32].
- Applicable pipe size up is decided upon field piping rules determined by the installation needs. See technical data and installer user reference guide for more details about the required pipe size up for your installation.

15.1.4 To select refrigerant branch kits

Refrigerant refnets

For piping example, refer to "15.1.3 To select the piping size" [p. 25].

- When using refnet joints at the first branch counted from the outdoor unit side, choose from the following table in accordance with the capacity of the outdoor unit (example: refnet joint c).

HP class	Refrigerant branch kit
8+10	KHRQ23M29T9
12~20	KHRQ23M64T
22~28	KHRQ23M75T

- For refnet joints other than the first branch, select the proper branch kit model based on the total capacity index of all indoor units connected after the refrigerant branch.

Indoor unit capacity index	Refrigerant branch kit
<200	KHRQ23M20T
200≤x<290	KHRQ23M29T9
290≤x<640	KHRQ23M64T
≥640	KHRQ23M75T

- Concerning refnet headers, choose from the following table in accordance with the total capacity of all the indoor units connected below the refnet header.

Indoor unit capacity index	Refrigerant branch kit
<290	KHRQ23M29H
290≤x<640	KHRQ23M64H
≥640	KHRQ23M75H

- For refnet joints between BS unit and indoor units

Indoor unit capacity index	Refrigerant branch kit
≤250	KHRQ22M20TA

INFORMATION

Maximum 8 branches can be connected to a header.

- Use the branch kit BHFQ23P907A for an outdoor multi connection piping kit for 2 outdoor units.

15.1.5 Multiple outdoor units: Possible layouts

- The piping between the outdoor units must be routed level or slightly upward to avoid the risk of oil retention into the piping.

Pattern 1

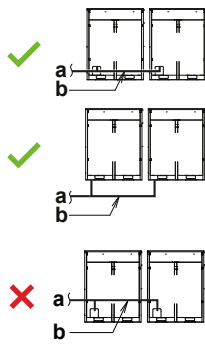

- a To indoor unit
- b Piping between outdoor units
- ✗ NOT allowed (oil remains in piping)
- ✓ Allowed

Pattern 2

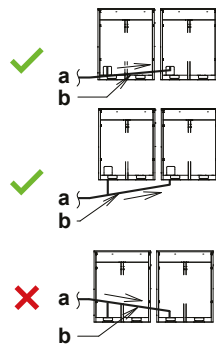

- To avoid the risk of oil retention to the outmost outdoor unit, always connect the stop valve and the piping between outdoor units as shown in the correct (✓) possibilities of the figure below.

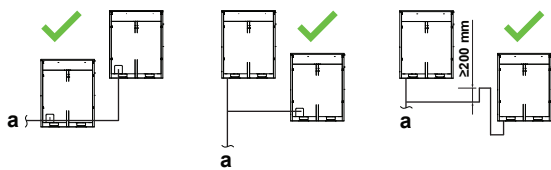
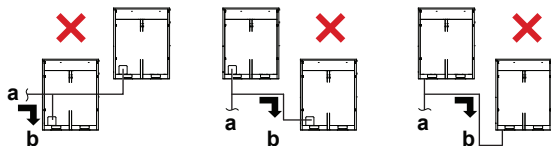
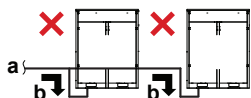
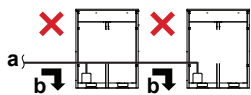
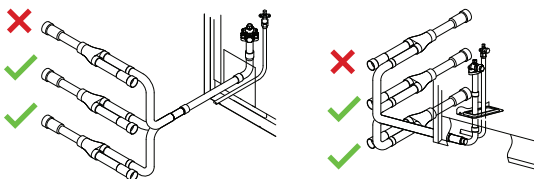

- a To indoor unit
- b Oil collects to the outmost outdoor unit when the system stops
- ✗ NOT allowed (oil remains in piping)
- ✓ Allowed

- If the piping length between the outdoor units exceeds 2 m, create a rise of 200 mm or more in the suction gas line and the high pressure/low pressure gas line within a length of 2 m from the kit.

If	Then
≤2 m	

If	Then
>2 m	

- a To indoor unit
- b Piping between outdoor units



NOTICE

There are restrictions on the refrigerant pipe connection order between outdoor units during installation in case of a multiple outdoor unit system. Install according to following restrictions. The capacities of outdoor units A and B must fulfill the following restriction conditions: A≥B.

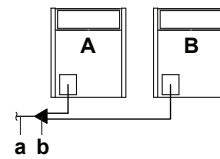

- a To indoor units
- b Outdoor unit multi connecting piping kit (first branch)

15.2 Connecting the refrigerant piping

15.2.1 Using the stop valve and service port

To handle the stop valve

Take the following guidelines into account:

- The gas and liquid stop valves are factory closed.
- Make sure to keep all stop valves open during operation.
- Do NOT apply excessive force to the stop valve. Doing so may break the valve body.

To open the stop valve

- 1 Remove the dust cap.
- 2 Insert a hexagon wrench into the stop valve.
- 3 FULLY turn the stop valve counterclockwise and tighten until the correct tightening torque value is achieved (see "Tightening torques" [▶ 28]).

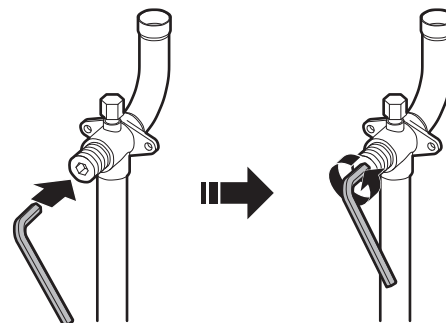

NOTICE

Stop valves need to be opened on torque specified in this manual. It is not allowed to turn valve "a quarter turn" back when opening it.

- 4 Install the dust cap.

Result: The valve is now open.

15 Piping installation

NOTICE

Reinstall dust cap to prevent aging of O-ring and risk of leakage.

To close the stop valve

- 1 Remove the stop valve cover.
- 2 Insert a hexagon wrench into the stop valve and turn the stop valve clockwise.

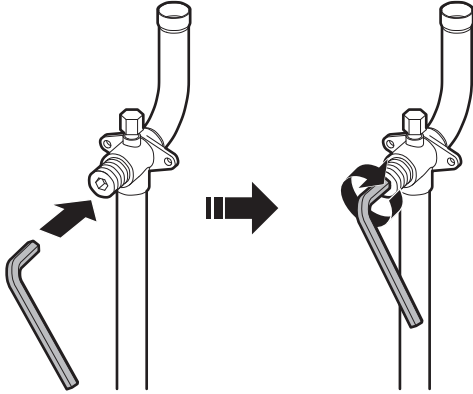

- 3 When the stop valve cannot be turned any further, stop turning.
- 4 Install the stop valve cover.

Result: The valve is now closed.

To handle the service port

- Always use a charge hose equipped with a valve depressor pin, since the service port is a Schrader type valve.
- After handling the service port, make sure to tighten the service port cover securely. For the tightening torque, refer to the table below.
- Check for refrigerant leaks after tightening the service port cover.

Tightening torques

Stop valve size [mm]	Tightening torque [N·m] ^(a)		
	Valve body	Hexagonal wrench	Service port
Ø9.5	5~7	4 mm	10.7~14.7
Ø12.7	8~10		
Ø15.9	14~16	6 mm	
Ø19.1	19~21	8 mm	
Ø25.4			

^(a) When opening or closing.

15.2.2 To route the refrigerant piping

Installation of refrigerant piping is possible as front connection or side connection (when taken out from the bottom) as shown in the figure below.

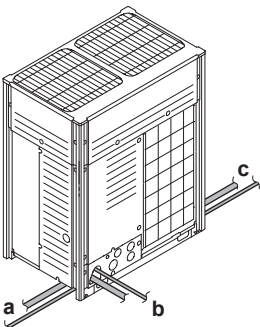

- a Left-side connection
- b Front connection
- c Right-side connection

Note: For side connections, remove the knockout hole on the bottom plate as shown below:

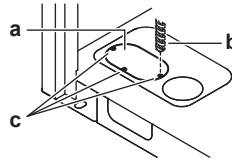

- a Large knockout hole
- b Drill
- c Points for drilling

NOTICE

Precautions when making knockout holes:

- Avoid damaging the casing.
- After making the knockout holes, we recommend you remove the burrs and paint the edges and areas around the edges using repair paint to prevent rusting.
- When passing electrical wiring through the knockout holes, wrap the wiring with protective tape to prevent damage.

15.2.3 To protect against contamination

Seal the piping and wiring intake holes using sealing material (field supply), otherwise the capacity of the unit will drop and small animals may enter the machine.

15.2.4 To remove the pinched pipes

WARNING

Any gas or oil remaining inside the stop valve may blow off the pinched piping.

Failure to observe the instructions in procedure below properly may result in property damage or personal injury, which may be serious depending on the circumstances.

Use the following procedure to remove the pinched piping:

- 1 Make sure that the stop valves are fully closed.



- 2 Connect the vacuuming/recovery unit through a manifold to the service port of all stop valves.

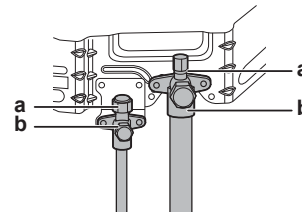

- a Service port
- b Stop valve

- 3 Recover gas and oil from the pinched piping by using a recovery unit.

CAUTION

Do NOT vent gases into the atmosphere.

- 4 When all gas and oil is recovered from the pinched piping, disconnect the charge hose and close the service ports.

- Cut off the lower part of the liquid-, gas-, and high pressure/low pressure gas stop valve pipes along the black line. Use an appropriate tool (e.g. a pipe cutter).

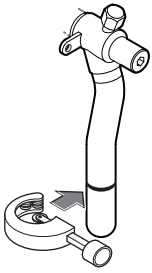

- Make sure that the total length of the piping connected to the joint is absolute straight for more than 500 mm. Only if a straight field piping of more than 120 mm is connected, more than 500 mm of straight section can be ensured.

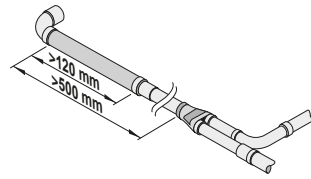

WARNING

NEVER remove the pinched piping by brazing.
Any gas or oil remaining inside the stop valve may blow off the pinched piping.

- Wait until all oil has dripped out before continuing with the connection of the field piping in case the recovery was not complete.

15.2.5 To connect the refrigerant piping to the outdoor unit

NOTICE

- Be sure to use the supplied accessory pipes when carrying out piping work in the field.
- Be sure that the field installed piping does not touch other pipes, the bottom panel or side panel. Especially for the bottom and side connection, be sure to protect the piping with suitable insulation, to prevent it from coming into contact with the casing.

Connect the stop valves to the field piping using the accessory pipes supplied with the unit.

The connections to the branch kits are the responsibility of the installer (field piping).

15.2.6 To connect the multi connection piping kit

NOTICE

Improper installation may lead to malfunction of the outdoor unit.

- Install the joints horizontally, so that the caution label (a) attached to the joint comes to the top.
 - Do not tilt the joint more than 7.5° (see view A).
 - Do not install the joint vertically (see view B).

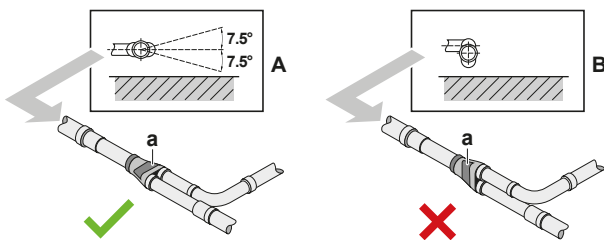

- a** Caution label
- NOT allowed
- Allowed

15.2.7 To connect the refrigerant branching kit

For installation of the refrigerant branching kit, refer to the installation manual delivered with the kit.

- Mount the refnet joint so that it branches either horizontally or vertically.
- Mount the refnet header so that it branches horizontally.

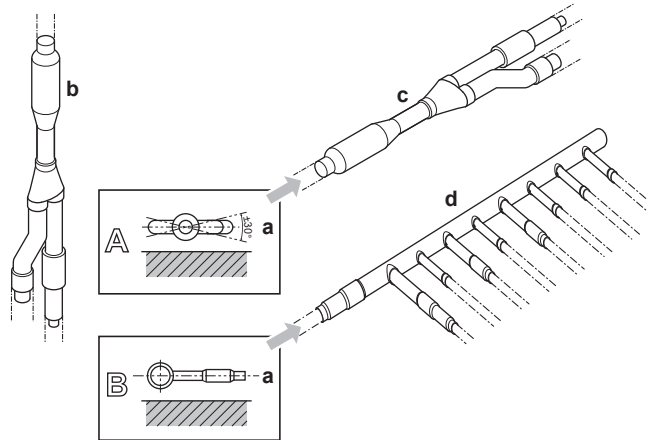

- a** Horizontal surface
- b** Refnet joint mounted vertically
- c** Refnet joint mounted horizontally
- d** Header

15.3 Checking the refrigerant piping

15.3.1 About checking the refrigerant piping

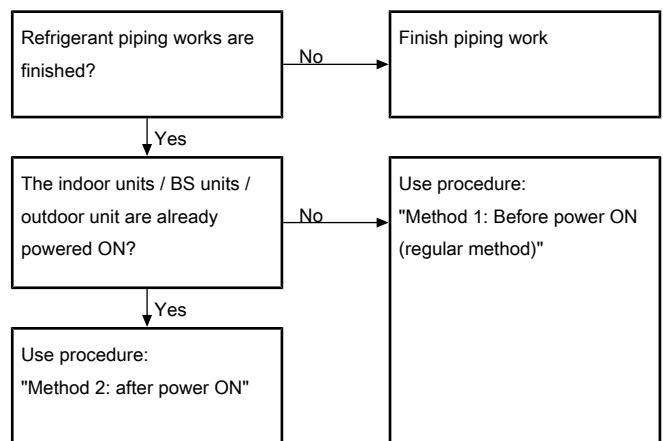

It is very important that all refrigerant piping work is done before the units (outdoor, BS unit or indoor) are powered on. When the units are powered on, the expansion valves will initialise. This means that the valves will close.

15 Piping installation

NOTICE

Leak test and vacuum drying of field piping, BS units and indoor units is impossible when field expansion valves are closed.

Method 1: Before power ON

If the system has not yet been powered on, no special action is required to perform the leak test and the vacuum drying.

Method 2: After power ON

If the system has already been powered on, activate setting [2-21] (refer to "18.1.4 To access mode 1 or 2" [p 41]). This setting will open field expansion valves to guarantee a refrigerant piping pathway and make it possible to perform the leak test and the vacuum drying.

DANGER: RISK OF ELECTROCUTION

NOTICE

Make sure that all indoor units and BS units connected to the outdoor unit are powered on.

NOTICE

Wait to apply setting [2-21] until the outdoor unit has finished the initialisation.

Leak test and vacuum drying

Checking the refrigerant piping involves:

- Checking for any leakages in the refrigerant piping.
- Performing vacuum drying to remove all moisture, air or nitrogen in the refrigerant piping.

If there is a possibility of moisture being present in the refrigerant piping (for example, water may have entered the piping), first carry out the vacuum drying procedure below until all moisture has been removed.

All piping inside the unit has been factory tested for leaks.

Only field installed refrigerant piping needs to be checked. Therefore, make sure that all the outdoor unit stop valves are firmly closed before performing leak test or vacuum drying.

NOTICE

Make sure that all (field supplied) field piping valves are OPEN (not outdoor unit stop valves!) before you start leak test and vacuuming.

For more information on the state of the valves, refer to "15.3.3 Checking refrigerant piping: Setup" [p 30].

15.3.2 Checking refrigerant piping: General guidelines

Connect the vacuum pump through a manifold to the service port of all stop valves to increase efficiency (refer to "15.3.3 Checking refrigerant piping: Setup" [p 30]).

NOTICE

Use a 2-stage vacuum pump with a non-return valve or a solenoid valve that can evacuate to a gauge pressure of -100.7 kPa (-1.007 bar).

NOTICE

Make sure the pump oil does not flow oppositely into the system while the pump is not working.

NOTICE

Do NOT purge the air with refrigerants. Use a vacuum pump to evacuate the installation.

15.3.3 Checking refrigerant piping: Setup

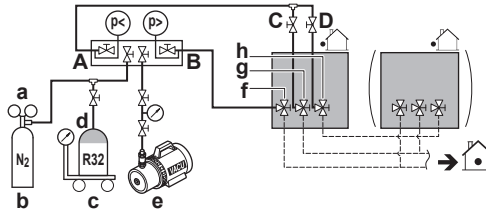

- a Pressure reducing valve
- b Nitrogen
- c Weighing scales
- d Refrigerant R32 tank (siphon system)
- e Vacuum pump
- f Liquid line stop valve
- g Gas line stop valve
- h High pressure/low pressure gas line stop valve
- A Valve A
- B Valve B
- C Valve C
- D Valve D

Valve	Status
Valve A	Open
Valve B	Open
Valve C	Open
Valve D	Open
Liquid line stop valve	Close
Gas line stop valve	Close
High pressure/low pressure gas line stop valve	Close

NOTICE

The connections to the indoor units and all indoor units should also be leak and vacuum tested. Keep any possible (field supplied) field piping valves open as well.

Refer to the indoor unit installation manual for more details. Leak test and vacuum drying should be done before the power supply is set to the unit. If not, see also the flow chart earlier described in this chapter (see "15.3.1 About checking the refrigerant piping" [p 29]).

15.3.4 To perform a leak test

The leak test must satisfy the specifications of EN378-2.

Vacuum leak test

- 1 Evacuate the system from the liquid and gas piping to a gauge pressure of -100.7 kPa (-1.007 bar) for more than 2 hours.
- 2 Once reached, turn off the vacuum pump and check that the pressure does not rise for at least 1 minute.
- 3 Should the pressure rise, the system may either contain moisture (see vacuum drying below) or have leaks.

Pressure leak test

- 1 Break the vacuum by pressurising with nitrogen gas to a minimum gauge pressure of 0.2 MPa (2 bar). Never set the gauge pressure higher than the maximum operation pressure of the unit, i.e. 4.0 MPa (40 bar).
- 2 Test for leaks by applying a bubble test solution to all piping connections.
- 3 Discharge all nitrogen gas.



NOTICE

ALWAYS use a recommended bubble test solution from your wholesaler.

NEVER use soap water:

- Soap water may cause cracking of components, such as flare nuts or stop valve caps.
- Soap water may contain salt, which absorbs moisture that will freeze when the piping gets cold.
- Soap water contains ammonia which may lead to corrosion of flared joints (between the brass flare nut and the copper flare).

15.3.5 To perform vacuum drying

To remove all moisture from the system, proceed as follows:

- 1 Evacuate the system for at least 2 hours to a target vacuum of -100.7 kPa (-1.007 bar) (5 Torr absolute).
- 2 Check that, with the vacuum pump turned off, the target vacuum is maintained for at least 1 hour.
- 3 Should you fail to reach the target vacuum within 2 hours or maintain the vacuum for 1 hour, the system may contain too much moisture. In that case, break the vacuum by pressurising with nitrogen gas to a gauge pressure of 0.05 MPa (0.5 bar) and repeat steps 1 to 3 until all moisture has been removed.
- 4 Depending on whether you want to immediately charge refrigerant through the refrigerant charge port or first pre-charge a portion of refrigerant through the liquid line, either open the outdoor unit stop valves, or keep them closed. See "16.2 About charging refrigerant" [▶ 32] for more information.

15.3.6 To insulate the refrigerant piping

After finishing the leak test and vacuum drying, the piping must be insulated. Take into account the following points:

- Make sure to insulate the connection piping and refrigerant branch kits entirely.
- Be sure to insulate the liquid and gas piping (for all units).
- Use heat resistant polyethylene foam which can withstand a temperature of 70°C for liquid piping and polyethylene foam which can withstand a temperature of 120°C for gas piping.
- Reinforce the insulation on the refrigerant piping according to the installation environment.

Ambient temperature	Humidity	Minimum thickness
$\leq 30^\circ\text{C}$	75% to 80% RH	15 mm
$> 30^\circ\text{C}$	$\geq 80\%$ RH	20 mm

Between outdoor and indoor unit

- 1 Insulate and fix the refrigerant piping and cables as follows:

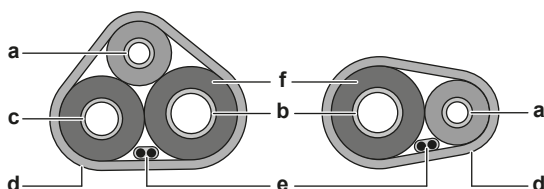

- a Liquid pipe
- b Gas pipe
- c High pressure / low pressure gas pipe
- d Finishing tape
- e Interconnection cable (F1/F2)
- f Insulation

- 2 Install the service cover.

Inside the outdoor unit

To insulate the refrigerant piping, proceed as follows:

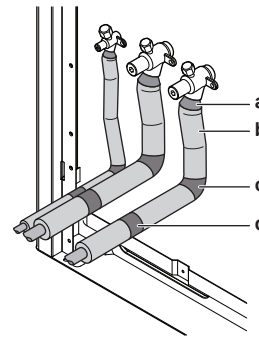

- a Sealant
- b Insulation
- c Vinyl tape around curves
- d Vinyl tape against sharp edges

- 1 Insulate the liquid, gas and HP/LP pipe.
- 2 Wind heat insulation around the curves, and then cover it with vinyl tape (c, see above).
- 3 Make sure the field piping does not touch any compressor components.
- 4 Seal the insulation ends (sealant etc.) (b, see above).
- 5 Wrap the field piping with vinyl tape (d, see above) to protect it against sharp edges
- 6 If the outdoor unit is installed above the indoor unit, cover the stop valves with sealing material to prevent condensed water on the stop valves from moving to the indoor unit.



NOTICE

Any exposed piping might cause condensation.

- 7 Reattach the service cover and the piping intake plate.
- 8 Seal all gaps to prevent snow and small animals from entering the system.



WARNING

Provide adequate measures to prevent that the unit can be used as a shelter by small animals. Small animals that make contact with electrical parts can cause malfunctions, smoke or fire.

15.3.7 To check for leaks after charging refrigerant

After charging refrigerant in the system an additional leak test must be performed. Refer to "16.9 To check refrigerant piping joints for leaks after charging refrigerant" [▶ 36].

16 Charging refrigerant

16.1 Precautions when charging refrigerant



WARNING

- Only use R32 as refrigerant. Other substances may cause explosions and accidents.
- R32 contains fluorinated greenhouse gases. Its global warming potential (GWP) value is 675. Do NOT vent these gases into the atmosphere.
- When charging refrigerant, ALWAYS use protective gloves and safety glasses.

16 Charging refrigerant



NOTICE

If the power of some units is turned off, the charging procedure cannot be finished properly.



NOTICE

In case of a multiple outdoor system, turn on the power of all outdoor units.



NOTICE

Turn ON the power 6 hours before operation in order to have power running to the crankcase heater and to protect the compressor.



NOTICE

If operation is performed within 12 minutes after the indoor and outdoor units are powered on, the compressor will not operate before the communication is established in a correct way between outdoor unit(s) and indoor units.



NOTICE

Make sure all connected indoor units are recognised (see [1-10] in "18.1.7 Mode 1: monitoring settings" [p 42]).



NOTICE

Before starting charging procedures, check if the 7-segment display indication of the outdoor unit A1P PCB is as normal (see "18.1.4 To access mode 1 or 2" [p 41]). If a malfunction code is present, see "22.1 Solving problems based on error codes" [p 48].



NOTICE

Close the front panel before any refrigerant charge operation is executed. Without the front panel attached the unit cannot judge correctly whether it is operating properly or not.



NOTICE

In case of maintenance and the system (outdoor unit + BS unit + field piping + indoor units) does not contain any refrigerant any more (e.g., after refrigerant reclaim operation), the unit has to be charged with its original amount of refrigerant (refer to the nameplate on the unit) and the determined additional refrigerant amount.



NOTICE

- Ensure that contamination of different refrigerants does not occur when using charging equipment.
- Charging hoses or lines shall be as short as possible to minimise the amount of refrigerant contained in them.
- Cylinders shall be kept in an appropriate position according to the instructions.
- Ensure that the refrigerating system is earthed prior to charging the system with refrigerant. See "17 Electrical installation" [p 36].
- Label the system when charging is complete.
- Extreme care shall be taken not to overfill the refrigerating system.



NOTICE

Prior to charging the system, it shall be pressure tested with the appropriate purging gas. The system shall be leak tested on completion of charging but prior to commissioning. A follow up leak test shall be carried out prior to leaving the site.

16.2 About charging refrigerant

Once vacuum drying and leak test are finished, additional refrigerant charging can start.

To speed up the refrigerant charging process, it is in case of larger systems recommended to first pre-charge a portion of refrigerant through the liquid line before proceeding with the actual charging. This step is included in below procedure (see "16.5 To charge refrigerant" [p 34]). It can be skipped, but charging will take longer then.

A flow chart is available which gives an overview of the possibilities and actions to be taken (see "16.4 To charge refrigerant: Flow chart" [p 34]).

16.3 To determine the additional refrigerant amount



WARNING

The maximum indoor capacity index which can be connected to a BS unit port is determined based on the smallest room served by that port.

In case the system serves the lowest underground floor of a building, there is an extra limit to the maximum allowable total refrigerant amount. This maximum refrigerant amount is determined based on the area of the smallest room on the lowest underground floor.

See "13 Special requirements for R32 units" [p 17] to determine the maximum allowable total refrigerant amount.



INFORMATION

For final charge adjustment in the test laboratory, please contact your local dealer.



INFORMATION

Note down the amount of additional refrigerant that is calculated here, for later use on the additional refrigerant charge label. See "16.8 To fix the fluorinated greenhouse gases label" [p 35].



NOTICE

The refrigerant charge of the system must be less than 63.8 kg. This means that in case the calculated total refrigerant charge is equal to or more than 63.8 kg you must divide your multiple outdoor system into smaller independent systems, each containing less than 63.8 kg refrigerant charge. For factory charge, refer to the unit name plate.



NOTICE

The total refrigerant charge amount in the system MUST always be lower than 15.96 [kg] × the number of indoor units connected downstream of BS units, with a maximum of 63.8 kg.

Formula:

$$R = [(X_1 \times \text{Ø}19.1) \times 0.23 + (X_2 \times \text{Ø}15.9) \times 0.16 + (X_3 \times \text{Ø}12.7) \times 0.10 + (X_4 \times \text{Ø}9.5) \times 0.053 + (X_5 \times \text{Ø}6.4) \times 0.020] \times 1.04 + (A + B + C)$$

R Additional refrigerant to be charged [kg] (rounded off to one decimal place)

$X_{1...5}$ Total length [m] of liquid piping size at Øa

A~C Parameters A~C (see below)



INFORMATION

- In case of a multi-outdoor-unit system, add the sum of the individual outdoor unit charge factors.
- When using more than one multi BS unit, add the sum of the individual BS unit charge factors.

- **Parameter A:** If the total indoor unit capacity connection ratio (CR)>100%, charge an additional 0.5 kg of refrigerant per outdoor unit.
- **Parameter B:** Outdoor unit charge factors

Model	Parameter B
REMA5	0 kg
REYA8~12	
REYA14	1.2 kg
REYA16	1.3 kg
REYA18	4.3 kg
REYA20	

- **Parameter C:** Individual BS unit charge factors

Model	Parameter C
BS4A	0.7 kg
BS6A	1.0 kg
BS8A	1.2 kg
BS10A	1.5 kg
BS12A	1.7 kg

Metric piping. When using metric piping, replace the weight factors in the formula by the ones from the following table:

Inch piping		Metric piping	
Piping	Weight factor	Piping	Weight factor
Ø6.4 mm	0.020	Ø6 mm	0.016
Ø9.5 mm	0.053	Ø10 mm	0.058
Ø12.7 mm	0.10	Ø12 mm	0.088
Ø15.9 mm	0.16	Ø15 mm	0.14
		Ø16 mm	0.16
Ø19.1 mm	0.23	Ø19 mm	0.22

16 Charging refrigerant

16.4 To charge refrigerant: Flow chart

For more information, see "16.5 To charge refrigerant" [p 34].

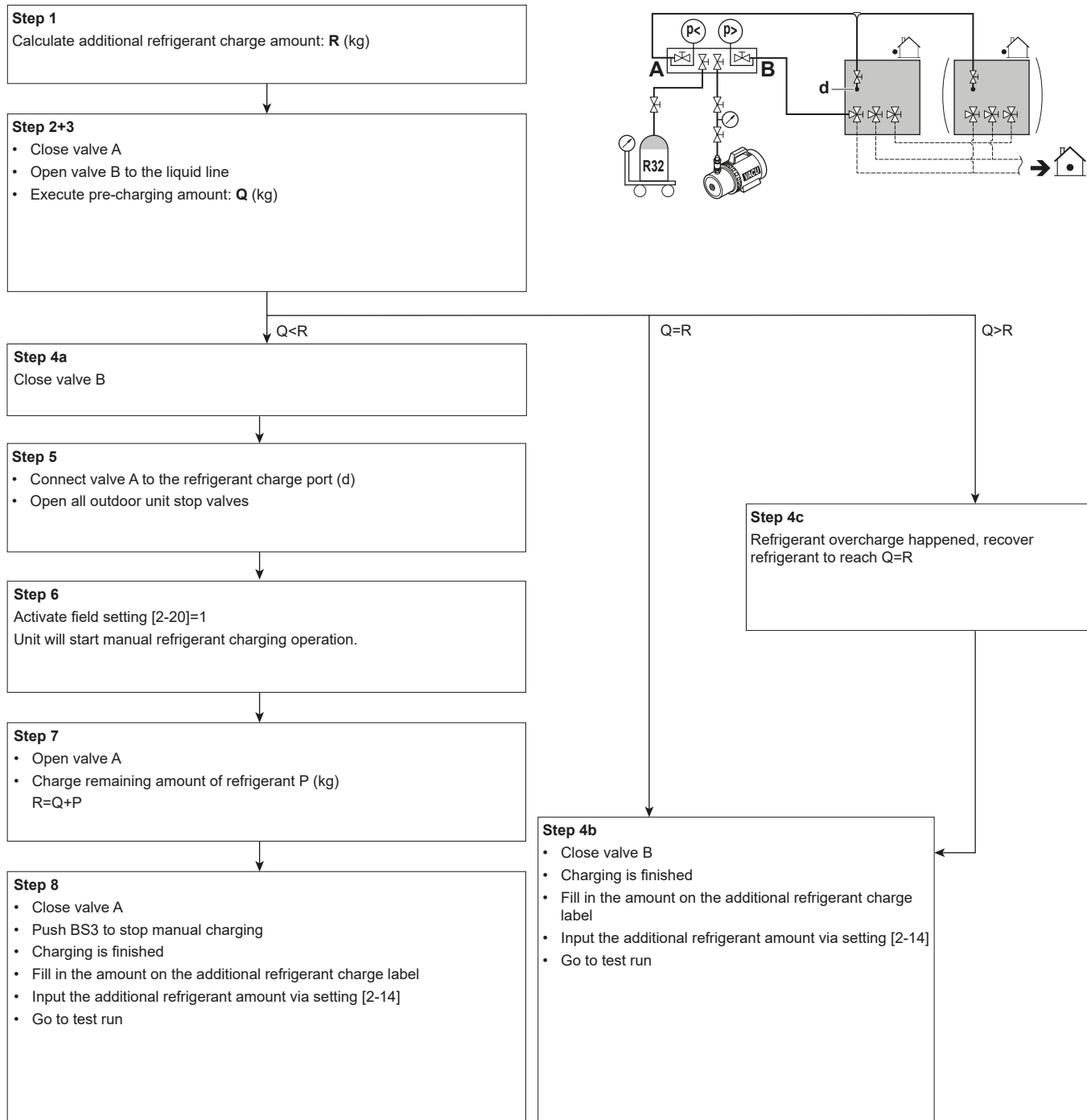

16.5 To charge refrigerant

To speed up the refrigerant charging process, it is in case of larger systems recommended to first pre-charge a portion of refrigerant through the liquid line before proceeding with the manual charging. It can be skipped, but charging will take longer then.

Pre-charging refrigerant

- 1 Calculate the additional amount of refrigerant to be added using the formula mentioned in "16.3 To determine the additional refrigerant amount" [p 32].

Note: The first 10 kg of additional refrigerant can be pre-charged without outdoor unit operation.

Note: Pre-charging can be done without compressor operation

Prerequisite: Make sure that all outdoor unit stop valves and manifold valve A are closed. Disconnect the manifold from the gas lines.

- 2 Connect the manifold valve B to the service port of the liquid stop valve.
- 3 Pre-charge refrigerant until the determined additional refrigerant amount is reached or pre-charging is not possible anymore.

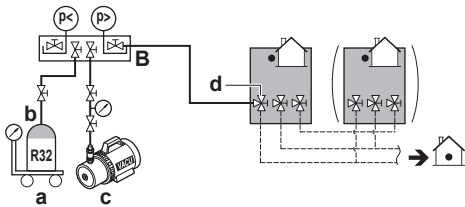

- a Weighing scales
- b Refrigerant R32 tank (siphon system)
- c Vacuum pump
- d Liquid line stop valve
- B Valve B

4 Do one of the following:

	If	Then
a	The determined additional refrigerant amount is not reached yet	Close valve B and disconnect the manifold from the liquid line. Continue with the "Charging refrigerant" procedure as described below.
b	The determined additional refrigerant amount is reached	Close valve B and disconnect the manifold from the liquid line. You do not have to perform the "Charging refrigerant" instructions described below.
c	Too much refrigerant is charged	Recover refrigerant. Disconnect the manifold from the liquid line. You do not have to perform the "Charging refrigerant" instructions described below.

Charging refrigerant

The remaining additional refrigerant charge can be charged by operating the outdoor unit by means of the manual additional refrigerant charge mode.

5 Connect as shown. Make sure valve A is closed. Open all outdoor unit stop valves.

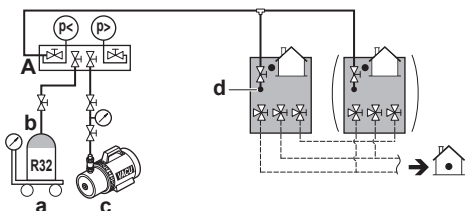

- a Weighing scales
- b Refrigerant R32 tank (siphon system)
- c Vacuum pump
- d Refrigerant charge port
- A Valve A

i INFORMATION

For a multi outdoor unit system, it is not required to connect all charge ports to a refrigerant tank.

The refrigerant will be charged with ± 1 kg per minute.

If you need to speed up in case of a multiple outdoor system, connect the refrigerant tanks to each outdoor unit.

! NOTICE

The refrigerant charging port is connected to the piping inside the unit. The unit's internal piping is already factory charged with refrigerant, so be careful when connecting the charge hose.

Prerequisite: Turn on the power of the indoor units and outdoor unit.

6 Activate setting [2-20] to start the manual additional refrigerant charge mode. For details, see "18.1.8 Mode 2: field settings" [42].

Result: The unit will start operation.

7 Open valve A and charge refrigerant until the remaining determined additional refrigerant amount is added, and then close valve A.

8 Close valve A and press BS3 to stop the manual additional refrigerant charge mode.

i INFORMATION

The manual refrigerant charge operation will automatically stop within 30 minutes. If charging is not completed after 30 minutes, perform the additional refrigerant charging operation again.

i INFORMATION

After charging refrigerant:

- Record the additional refrigerant amount on the refrigerant label provided with the unit and attach it to the backside of the front panel.
- Input the additional refrigerant amount into the system via setting [2-14].
- Perform the test procedure described in "19 Commissioning" [44].

! NOTICE

Make sure to open all stop valves after (pre-) charging the refrigerant.

Operating with the stop valves closed will damage the compressor.

! NOTICE

After adding the refrigerant, do not forget to close the lid of the refrigerant charging port. The tightening torque for the lid is 11.5 to 13.9 N·m.

16.6 Error codes when charging refrigerant

If a malfunction occurs, close valve A immediately. Confirm the malfunction code and take corresponding action, "22.1 Solving problems based on error codes" [48].

16.7 Checks after charging refrigerant

- Are all stop valves open?
- Is the amount of refrigerant, that has been added, recorded on the refrigerant charge label?

! NOTICE

Make sure to open all stop valves after (pre-) charging the refrigerant.

Operating with the stop valves closed will damage the compressor.

16.8 To fix the fluorinated greenhouse gases label

- 1 Fill in the label as follows:

17 Electrical installation

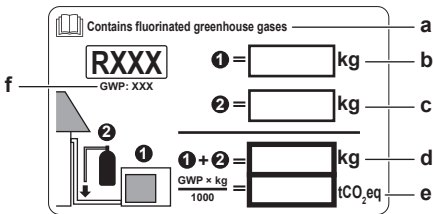

- a If a multilingual fluorinated greenhouse gases label is delivered with the unit (see accessories), peel off the applicable language and stick it on top of a.
- b Factory refrigerant charge: see unit name plate
- c Additional refrigerant amount charged
- d Total refrigerant charge
- e **Quantity of fluorinated greenhouse gases** of the total refrigerant charge expressed as tonnes CO₂ equivalent.
- f GWP = Global Warming Potential



NOTICE

Applicable legislation on **fluorinated greenhouse gases** requires that the refrigerant charge of the unit is indicated both in weight and CO₂ equivalent.

Formula to calculate the quantity in CO₂ equivalent tonnes: GWP value of the refrigerant × total refrigerant charge [in kg] / 1000

Use the GWP value mentioned on the refrigerant charge label.

- 2 Fix the label on the inside of the outdoor unit near the gas and liquid stop valves.

16.9 To check refrigerant piping joints for leaks after charging refrigerant

Tightness test of field-made refrigerant joints indoors

- 1 Use a leakage test method with a minimum sensitivity of 5 g of refrigerant/year. Test leaks using a pressure of at least 0.25 times the maximum working pressure (see "PS High" on the unit nameplate).

If a leak is detected

- 1 Recover the refrigerant, repair the joint, and repeat the test.
- 2 Perform the leak tests see "[15.3.4 To perform a leak test](#)" [▶ 30].
- 3 Charge refrigerant.
- 4 Check for refrigerant leaks after charging (see above).

17 Electrical installation



CAUTION

See "[2 Specific installer safety instructions](#)" [▶ 4] to make sure this installation complies with all safety regulations.

17.1 About electrical compliance

This equipment complies with:

- **EN/IEC 61000-3-11** provided that the system impedance Z_{sys} is less than or equal to Z_{max} at the interface point between the user's supply and the public system.
 - EN/IEC 61000-3-11 = European/International Technical Standard setting the limits for voltage changes, voltage fluctuations and flicker in public low-voltage supply systems for equipment with rated current ≤ 75 A.
- It is the responsibility of the installer or user of the equipment to ensure, by consultation with the distribution network operator if necessary, that the equipment is connected **ONLY** to a supply with a system impedance Z_{sys} less than or equal to Z_{max} .
- **EN/IEC 61000-3-12** provided that the short-circuit power S_{sc} is greater than or equal to the minimum S_{sc} value at the interface point between the user's supply and the public system.
 - EN/IEC 61000-3-12 = European/International Technical Standard setting the limits for harmonic currents produced by equipment connected to public low-voltage systems with input current > 16 A and ≤ 75 A per phase.
- It is the responsibility of the installer or user of the equipment to ensure, by consultation with the distribution network operator if necessary, that the equipment is connected **ONLY** to a supply with a short-circuit power S_{sc} greater than or equal to the minimum S_{sc} value.

Single outdoor unit		
Model	Z_{max} [Ω]	Minimum S_{sc} value [kVA]
REMA5	—	2598
REYA8	—	2789
REYA10	—	3810
REYA12	—	4157
REYA14	—	4676
REYA16	—	5369
REYA18	—	6062
REYA20	—	7274

Multiple outdoor units		
Model	Z_{max} [Ω]	Minimum S_{sc} value [kVA]
REYA10	—	5196
REYA13	—	5387
REYA16	—	5577
REYA18	—	6599
REYA20	—	6945
REYA22	—	7967
REYA24	—	8158
REYA26	—	8833
REYA28	—	9526



INFORMATION

Multi units are standard combinations.

17.2 Specifications of standard wiring components

Component		Single outdoor units							
		REMA5	REYA8	REYA10	REYA12	REYA14	REYA16	REYA18	REYA20
Power supply cable	MCA ^(a)	15 A	16.1 A	22 A	24 A	27 A	31 A	35 A	42 A
	Voltage	380-415 V							
	Phase	3N~							
	Frequency	50 Hz							
	Wire size	5 core cable							
		Must comply with national wiring regulation.							
Wire size based on the current, but not less than:									
		2.5 mm ²		4 mm ²		6 mm ²		10 mm ²	
Interconnection cable	Voltage	220-240 V							
	Wire size	Only use harmonised wire providing double insulation and suitable for applicable voltage.							
		2-core cable 0.75-1.5 mm ²							
Recommended field fuse		20 A	25 A	32 A	32 A	40 A	40 A	50 A	
Earth leakage circuit breaker/ residual current circuit breaker		Must comply with national wiring regulation.							

^(a) MCA=Minimum circuit ampacity. Stated values are maximum values.

Please use the table above to specify the requirements for the power supply wiring.



NOTICE

When using residual current operated circuit breakers, be sure to use a high-speed type 300 mA rated residual operating current.



NOTICE

We recommend using solid (single-core) wires. If stranded wires are used, slightly twist the strands to consolidate the end of the conductor for either direct use in the terminal clamp or insertion in a round crimp-style terminal. Details are described in "Guidelines when connecting the electrical wiring" in the installer reference guide.

17.3 To route and fix the interconnection wiring



NOTICE

Sheathed and shielded cables are required for interconnection wiring between outdoor unit and BS unit.

Interconnection wiring can be routed through the front side only. Fix it to the upper mounting hole.

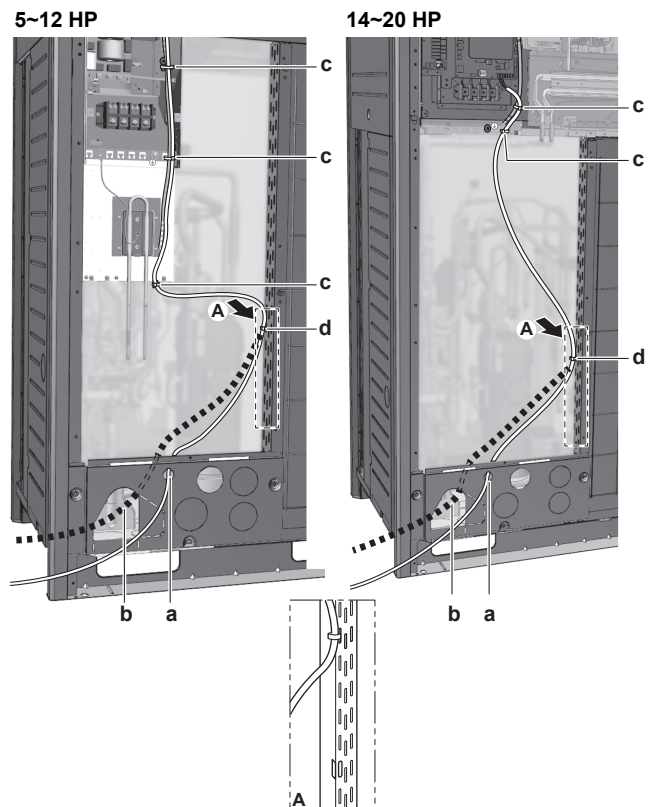

- a Interconnection wiring (possibility 1)^(a)
- b Interconnection wiring (possibility 2)^(a)
- c Tie wrap. Fix to factory-mounted low voltage wiring.
- ^(a) Knockout hole has to be removed. Close the hole to avoid small animals or dirt from entering.

17 Electrical installation

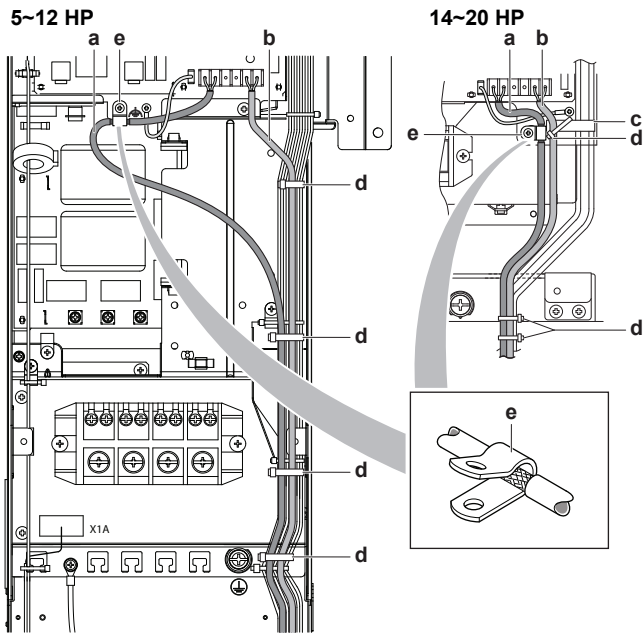

- a Wiring between the units (indoor-outdoor) (F1/F2 left)
- b Internal interconnection wiring (Q1/Q2)
- c Plastic bracket
- d Tie wrap (field supply)
- e P-clamp for cable shield earthing

Fix to the indicated plastic brackets using field supplied clamping material.

The indoor F1/F2 interconnection wiring for MUST be shielded wire. The shielding is earthed via a metal P-clamp (e) (only at outdoor unit). Strip the insulation up to the shielding mesh, to provide full contact of the earth with the shielding.

17.4 To connect the interconnection wiring

The wiring from the indoor units must be connected to the F1/F2 (In-Out) terminals on the PCB in the outdoor unit.

See Specifications of standard wiring components for wiring requirements.

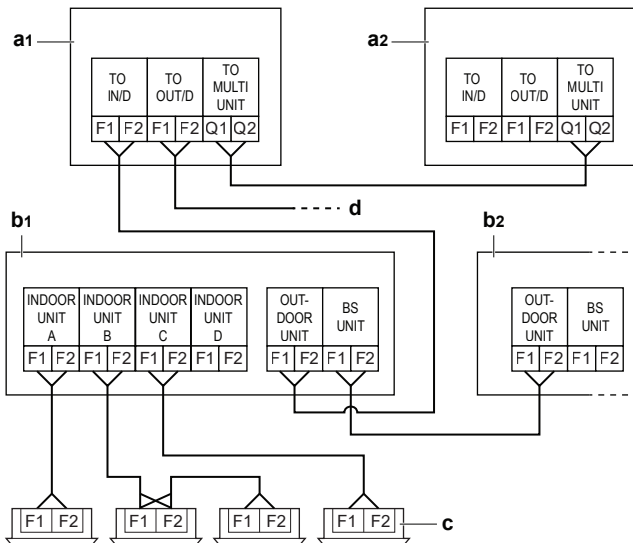

- a1 Unit A (master outdoor unit)
- a2 Unit B (slave outdoor unit)
- b1 BS unit 1
- b2 BS unit 2
- c Indoor unit
- d Outdoor unit/other system interconnection (F1/F2)

- The interconnecting wiring between the outdoor units in the same piping system must be connected to the Q1/Q2 (Out Multi) terminals. Connecting the wires to the F1/F2 terminals results in system malfunction.
- The wiring for the other systems must be connected to the F1/F2 (Out-Out) terminals of the PCB in the outdoor unit to which the interconnecting wiring for the indoor units is connected.
- The base unit is the outdoor unit to which the interconnecting wiring for the indoor units is connected.

Tightening torque for the interconnection wiring terminal screws:

Screw size	Tightening torque [N·m]
M3.5 (A1P)	0.8~0.96

17.5 To finish the interconnection wiring

After installing the interconnection wiring, wrap it along with the onsite refrigerant pipes using finishing tape, as shown in the illustration below.

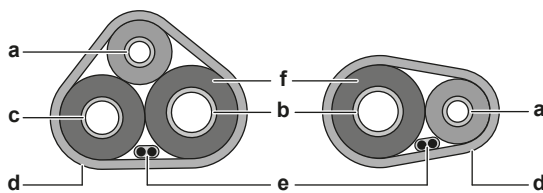

- a Liquid pipe
- b Gas pipe
- c High pressure / low pressure gas pipe
- d Finishing tape
- e Interconnection cable (F1/F2)
- f Insulation

17.6 To route and fix the power supply



NOTICE

When routing earth wires, secure clearance of 25 mm or more away from compressor lead wires. Failure to observe this instruction properly may adversely affect correct operation of other units connected to the same earth.

The power supply wiring can be routed from the front and left side. Fix it to the lower mounting hole.

5~12 HP

14~20 HP

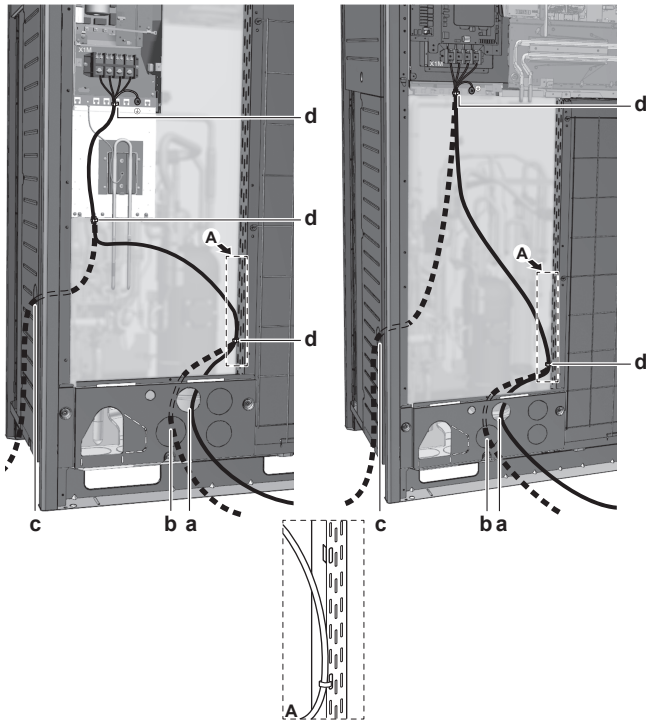

- a Power supply (possibility 1)^(a)
- b Power supply (possibility 2)^(a)
- c Power supply (possibility 3)^(a). Use conduit.
- d Tie wrap
- ^(a) Knockout hole has to be removed. Close the hole to avoid small animals or dirt from entering.

- h Tie wrap
- i Cup washer
- j When connecting the earth wire, it is recommended to perform curling.



NOTICE

Never connect the power supply to transmission wiring terminal block. Otherwise the entire system may break down.



CAUTION

- When connecting the power supply: connect the earth cable first, before making the current-carrying connections.
- When disconnecting the power supply: disconnect the current-carrying cables first, before separating the earth connection.
- The length of the conductors between the power supply stress relief and the terminal block itself **MUST** be as such that the current-carrying wires are tautened before the earth wire is in case the power supply is pulled loose from the stress relief.

Tightening torque for the terminal screws:

Screw size	Tightening torque (N•m)
M8 (power terminal block)	5.5~7.3
M8 (ground)	



NOTICE

When connecting the earth wire, align the wire with the cut out section of the cup washer. Incomplete earthing may cause electrical shock.

17.7 To connect the power supply

The power supply **MUST** be clamped to the bracket using field supplied clamp material to prevent external force being applied to the terminal. The green and yellow striped wire **MUST** be used for earthing only.

See Specifications of standard wiring components for wiring requirements.

5~12 HP

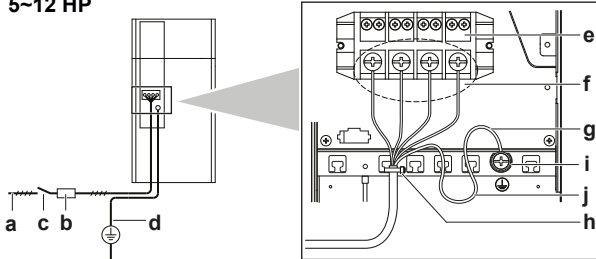

14~20 HP

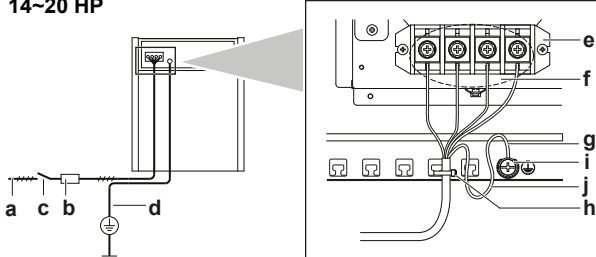

- a Power supply (380~415 V, 3N~ 50 Hz)
- b Fuse
- c Earth leakage protector
- d Earth wire
- e Power supply terminal block
- f Connect each power wire: RED to L1, WHT to L2, BLK to L3 and BLU to N
- g Earth wire (GRN/YLW)

Multiple outdoor units

To connect the power supply for multiple outdoor units to each other, ring tongues have to be used. No bare cable can be used.

In that case, the ring washer that is installed by default should be removed.

Attach both cables to the power supply terminal as indicated below:

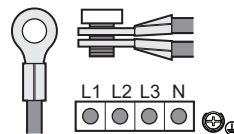

17.8 To connect the external outputs

SVS and SVEO output

The SVS and SVEO outputs are contacts on terminal X2M.

The SVS output is a contact on terminal X2M that closes in case a leak is detected, failure or disconnection of the R32 sensor (located in the BS unit or indoor unit).

The SVEO output is a contact on terminal X2M that closes in case of occurrence of general errors. See "8.1 Error codes: Overview" [▶ 13] and "22.1.1 Error codes: Overview" [▶ 48] for errors that will trigger this output.

Outdoor output connection requirements	
Voltage	220~240 V
Maximum current	0.5 A
Wire size	Only use harmonised wiring providing double insulation and suitable for the applicable voltage. 2-core cable Minimum cable section of 0.75 mm ²

18 Configuration



NOTICE

Do NOT use the outputs as a power source. Instead, use each output to energize a relay that controls the external circuit.

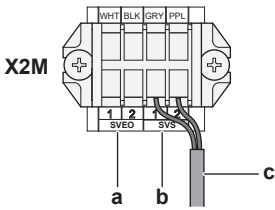

- a SVEO output terminals (1 and 2)
- b SVS output terminals (1 and 2)
- c Cable to SVS output device (example)

Example:

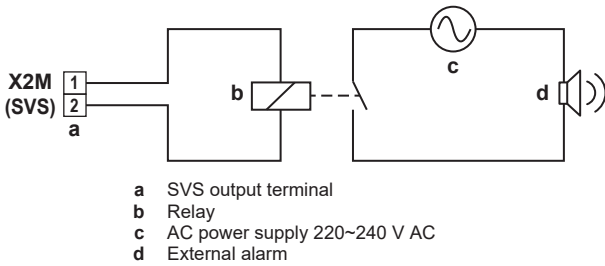

- a SVS output terminal
- b Relay
- c AC power supply 220~240 V AC
- d External alarm

Cable routing

Route the SVEO or SVS output cable as indicated below.

5~12 HP

14~20 HP

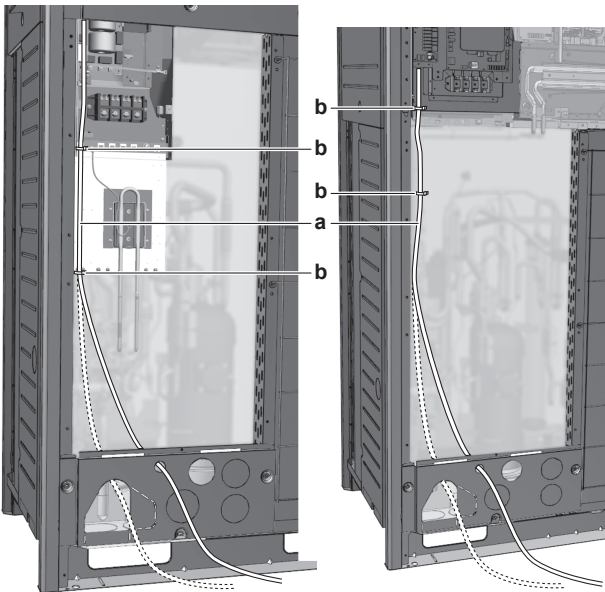

- a Output cable (SVEO or SVS)(field supply)
- b Cable tie (accessory)
- Alternate routing



INFORMATION

Sound data about the refrigerant leakage alarm are available in the technical data sheet of the user interface. E.g. the BRC1H52* controller generates an alarm of 65 dB (sound pressure, measured at 1 m distance from the alarm).

17.9 To check the insulation resistance of the compressor



NOTICE

If, after installation, refrigerant accumulates in the compressor, the insulation resistance over the poles can drop, but if it is at least 1 MΩ, then the unit will not break down.

- Use a 500 V mega-tester when measuring insulation.
- Do NOT use a mega-tester for low voltage circuits.

- 1 Measure the insulation resistance over the poles.

If	Then
≥1 MΩ	Insulation resistance is OK. This procedure is finished.
<1 MΩ	Insulation resistance is not OK. Go to the next step.

- 2 Turn ON the power and leave it on for 6 hours.

Result: The compressor will heat up and evaporate any refrigerant in the compressor.

- 3 Measure the insulation resistance again.

18 Configuration



DANGER: RISK OF ELECTROCUTION



INFORMATION

It is important that all information in this chapter is read sequentially by the installer and that the system is configured as applicable.

18.1 Making field settings

18.1.1 About making field settings

To continue the configuration of the VRV 5 heat recovery system, it is required to give some input to the PCB of the unit. This chapter will describe how manual input is possible by operating the push buttons on the PCB and reading the feedback from the 7-segment displays.

Making settings is done via the master outdoor unit.

Next to making field settings it is also possible to confirm the current operation parameters of the unit.

Push buttons

Performing special actions (refrigerant charge, test run, etc.) and making field settings (demand operation, low noise, etc.) happens by way of operating the push buttons.

See also:

- ["18.1.2 Field setting components" \[p 41\]](#)
- ["18.1.3 To access the field setting components" \[p 41\]](#)

Mode 1 and 2

Mode	Description
Mode 1 (monitoring settings)	Mode 1 can be used to monitor the current situation of the outdoor unit. Some field setting contents can be monitored as well.

Mode	Description
Mode 2 (field settings)	<p>Mode 2 is used to change the field settings of the system. Consulting the current field setting value and changing the current field setting value is possible.</p> <p>In general, normal operation can be resumed without special intervention after changing field settings.</p> <p>Some field settings are used for special operation (e.g., one time operation, recovery/vacuumping setting, manual adding refrigerant setting, etc.). In such a case, it is required to abort the special operation before normal operation can restart. It will be indicated in below explanations.</p>

See also:

- "18.1.4 To access mode 1 or 2" [▶ 41]
- "18.1.5 To use mode 1" [▶ 42]
- "18.1.6 To use mode 2" [▶ 42]
- "18.1.7 Mode 1: monitoring settings" [▶ 42]
- "18.1.8 Mode 2: field settings" [▶ 42]

18.1.2 Field setting components

Location of the 7-segment displays, buttons and DIP switches:

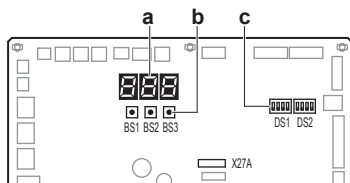

- BS1** MODE: for changing the set mode
- BS2** SET: for field setting
- BS3** RETURN: for field setting
- DS1, DS2** DIP switches
- a** 7-segment displays
- b** Push buttons
- c** DIP switches

18.1.3 To access the field setting components

It is not required to open the complete electronic component box to access the push buttons on the PCB and read out the 7-segment display(s).

To access you can remove the front inspection cover of the front plate (see figure). Now you can open the inspection cover of the electrical component box front plate (see figure). You can see the three push buttons and the three 7-segment displays and DIP switches.

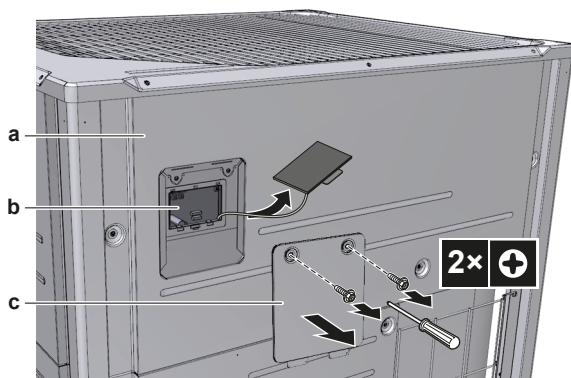

- a** Front plate
- b** Main PCB with three 7-segment displays and three push buttons
- c** Electrical component box service cover

Operate the switches and push buttons with an insulated stick (such as a closed ball-point pen) to avoid touching of live parts.

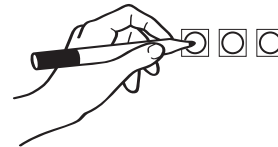

Make sure to re-attach the inspection cover into the electronic component box cover and to close the front plate's inspection cover after the job is finished. During operation of the unit the front plate of the unit should be attached. Settings are still possible to be made through the inspection opening.



NOTICE

Make sure that all outside panels, except for the service cover on the electrical component box, are closed while working.

Close the lid of the electrical component box firmly before turning on the power.

18.1.4 To access mode 1 or 2

Initialisation: default situation



NOTICE

Turn ON the power 6 hours before operation in order to have power running to the crankcase heater and to protect the compressor.

Turn on the power supply of the outdoor unit and all indoor units. When the communication between indoor units and outdoor unit(s) is established and normal, the 7-segment display indication state will be as below (default situation when shipped from factory).

Stage	Display
When turning on the power supply: flashing as indicated. First checks on power supply are executed (8~10 min).	
When no trouble occurs: lighted as indicated (1~2 min).	
Ready for operation: blank display indication as indicated.	

7-segment display indications:

	Off
	Blinking
	On

In case of malfunction, the malfunction code is displayed on the indoor unit user interface and the outdoor unit 7-segment display. Solve the malfunction code accordingly. The communication wiring should be checked at first.

Access

BS1 is used to switch between the default situation, mode 1 and mode 2.

Access	Action
Default situation	
Mode 1	<ul style="list-style-type: none"> • Push BS1 one time. <p>7-segment display indication changes to:</p> <ul style="list-style-type: none"> • Push BS1 one more time to return to the default situation.

18 Configuration

Access	Action
Mode 2	<ul style="list-style-type: none"> Push BS1 for at least five seconds. 7-segment display indication changes to: <div style="text-align: center;">  </div> <ul style="list-style-type: none"> Push BS1 one more time (short) to return to the default situation.



INFORMATION

If you get confused in the middle of the process, push BS1 to return to the default situation (no indication on 7-segment displays: blank, see "18.1.4 To access mode 1 or 2" ▶ 41).

18.1.5 To use mode 1

Mode 1 is used to set basic settings and to monitor the status of the unit.

What	How
Changing and accessing the setting in mode 1	1 Push BS1 one time to select mode 1. 2 Push BS2 to select the required setting. 3 Push BS3 one time to access the selected setting's value.
To quit and return to the initial status	Push BS1.

18.1.6 To use mode 2

The master unit should be used to input field settings in mode 2.

Mode 2 is used to set field settings of the outdoor unit and system.

What	How
Changing and accessing the setting in mode 2	<ul style="list-style-type: none"> Push BS1 for more than five seconds to select mode 2. Push BS2 to select the required setting. Push BS3 one time to access the selected setting's value.
To quit and return to the initial status	Push BS1.
Changing the value of the selected setting in mode 2	<ul style="list-style-type: none"> Push BS1 for more than five seconds to select mode 2. Push BS2 to select the required setting. Push BS3 one time to access the selected setting's value. Push BS2 to select the required value of the selected setting. Push BS3 one time to validate the change. Push BS3 again to start operation with the chosen value.

18.1.7 Mode 1: monitoring settings

Shows whether the unit you check is a master or slave unit.

The master unit should be used to input field settings in mode 2.

[1-0]	Description
No indication	Undefined situation.

[1-0]	Description
0	Outdoor unit is master unit.
1	Outdoor unit is slave 1 unit.

[1-1]

Shows the status of low noise operation.

[1-1]	Description
0	Unit is currently not operating under low noise restrictions.
1	Unit is currently operating under low noise restrictions.

[1-2]

Shows the status of power consumption limitation operation.

[1-2]	Description
0	Unit is currently not operating under power consumption limitations.
1	Unit is currently operating under power consumption limitation.

[1-5] [1-6]

Code	Shows ...
[1-5]	The current T_e target parameter position
[1-6]	The current T_c target parameter position

[1-10]

Shows the total number of connected indoor units.

[1-13]

Shows the total number of connected outdoor units (in case of multiple outdoor system).

[1-17] [1-18] [1-19]

Code	Shows ...
[1-17]	The latest malfunction code
[1-18]	The 2nd last malfunction code
[1-19]	The 3rd last malfunction code

[1-29] [1-30] [1-31]

Shows the result of the leak detection function.

Result	Description
---	No data
E_{rr}	Leak detection failure due to abnormal operation
σH	No leak detected
$\sigma \bar{U}$	Leak detected

[1-34]

Shows the remaining days until the next automatic leak detection (if automatic leak detection function is activated).

[1-40] [1-41]

Code	Shows ...
[1-40]	The current cooling comfort setting
[1-41]	The current heating comfort setting

18.1.8 Mode 2: field settings

[2-8]

T_e target temperature during cooling operation.

[2-8]	T_e target [°C]
0 (default)	Auto
2	6

[2-8]	T _e target [°C]
3	7
4	8
5	9
6	10
7	11

[2-9]

T_c target temperature during heating operation.

[2-9]	T _c target [°C]
0 (default)	Auto
1	41
2	42
3	43
4	44
5	45
6	46

[2-14]

Input additional refrigerant amount that was charged.

In case you want to use the automatic leak detection functionality, it is required to input the total additional refrigerant charge amount.

[2-14]	Additional amount charged [kg]
0 (default)	No input
1	0<x<5
2	5<x<10
3	10<x<15
4	15<x<20
5	20<x<25
6	25<x<30
7	30<x<35
8	35<x<40
9	40<x<45
10	45<x<50
11	50<x<55
12	55<x<60
13	Setting cannot be used. Total refrigerant charge MUST be <63.8 kg.
14	
15	

- For details concerning the calculation of additional refrigerant charge amount, see "16.3 To determine the additional refrigerant amount" [▶ 32].
- For guidance concerning the input of the additional refrigerant charge amount and leak detection function see "18.2 Using the leak detection function" [▶ 44].

[2-20]

Manual additional refrigerant charge/BS/indoor unit connection check

[2-20]	Description
0 (default)	Manual additional refrigerant charge deactivated.

[2-20]	Description
1	Manual additional refrigerant charge activated. To stop the manual additional refrigerant charge operation (when the required additional refrigerant amount is charged), push BS3. If this function was not aborted by pushing BS3, the unit will stop its operation after 30 minutes. If 30 minutes was not sufficient to add the needed refrigerant amount, the function can be reactivated by changing the field setting again.
2	Perform a BS/indoor unit connection check. Perform a BS units and indoor units connection check where for each indoor unit is checked if the piping and communication wiring are connected to the same branch pipe port.

[2-22]

Automatic low noise setting and level during night time.

By changing this setting, you activate the automatic low noise operation function of the unit and define the level of operation. Depending on the chosen level, the noise level will be lowered. The start and stop moments for this function are defined under setting [2-26] and [2-27]. For more details about settings [2-26] and [2-27], see installer user reference guide

[2-22]	Description	
0 (default)	Deactivated	
1	Level 1	Level 5<Level 4<Level 3<Level 2<Level 1
2	Level 2	
3	Level 3	
4	Level 4	
5	Level 5	

[2-35]

Height difference setting.

[2-35]	Description
0	In case the outdoor unit is installed in the lowest position (indoor units are installed on a higher position than outdoor units) and the height difference between the highest indoor unit and the outdoor unit exceeds 40 m, the setting [2-35] should be changed to 0.
1 (default)	—

[2-47]

T_e target temperature during heat recovery operation.

[2-47]	T _e target [°C]
0 (default)	Auto
2	6
3	7
4	8
5	9
6	10
7	11

[2-49]

Height difference setting.

[2-49]	Description
0 (default)	—

19 Commissioning

[2-49]	Description
1	In case the outdoor unit is installed in the highest position (indoor units are installed on a lower position than outdoor units) and the height difference between the lowest indoor unit and the outdoor unit exceeds 50 m, the setting [2-49] has to be changed to 1.

[2-58]

Maintenance cycle for BS unit AFR check (1 year=365 days)

[2-58]	Description
0	Timer reset
1	1 year
2	2 years
3 (default)	5 years
4	10 years

[2-60]

Supervisor remote controller setting. A power reset is required to save this setting.

For details about the supervisor remote controller, see "[13.2 System layout requirements](#)" [p. 17] or refer to the remote controller installation and user reference guide.

[2-60]	Description
0 (default)	No supervisor remote controller connected to the system
1	Supervisor remote controller connected to system

[2-65]

Automatic leak detection interval time.

This setting is used in conjunction with setting [2-88].

[2-65]	Time between automatic leak detection executions [days]
0 (default)	365
1	180
2	90
3	60
4	30
5	7
6	1

[2-88]

Automatic leak detection activation.

When you want to use the automatic leak detection function you have to activate this setting. By activating setting [2-88], the automatic leak detection will be executed depending on the defined value setting. The timing for the next automatic refrigerant leak detection is subject to setting [2-65]. The automatic leak detection will be executed in [2-65] days.

Each time when the automatic leak detection function was executed the system will stay idle until it is restarted by manual thermo ON request or by next scheduled action.

[2-88]	Description
0 (default)	No leak detection planned.
1	Leak detection planned once in [2-65] days.
2	Leak detection planned every [2-65] days.

18.2 Using the leak detection function

18.2.1 About automatic leak detection

The (automatic) leak detection function is not by default activated and can only start working when the additional refrigerant charge was input into the system's logic (see [2-14]).

The leak detection operation can be automated. By changing parameter [2-88] to chosen value, the interval time or the time until the next automatic leak detection operation can be chosen. The parameter [2-88] defines whether the leak detection operation is executed one time (within [2-65] days) or intermittent, respecting an interval of [2-65] days.

Availability of the leak detection function feature requires input of the additional refrigerant charge amount immediately after finishing the charging. The input must be executed before performing the test operation.



NOTICE

If a wrong value is input for the additional charged refrigerant weight, the accuracy of the leak detection function will decrease.



INFORMATION

- The weighed and already recorded amount of additional refrigerant charge (not the total amount of refrigerant present in the system) must be entered.
- When the height difference between indoor units is $\geq 50/40$ m, the leak detection function can not be used.

19 Commissioning



CAUTION

See "[2 Specific installer safety instructions](#)" [p. 4] to make sure commissioning complies with all safety regulations.



NOTICE

General commissioning checklist. Next to the commissioning instructions in this chapter, a general commissioning checklist is also available on the Daikin Business Portal (authentication required).

The general commissioning checklist is complementary to the instructions in this chapter and can be used as a guideline and reporting template during commissioning and hand-over to the user.

19.1 Precautions when commissioning



CAUTION

Do NOT perform the test operation while working on the indoor units.

When performing the test operation, NOT ONLY the outdoor unit, but the connected indoor unit will operate as well. Working on an indoor unit while performing a test operation is dangerous.



NOTICE

Turn ON the power 6 hours before operation in order to have power running to the crankcase heater and to protect the compressor.

During test operation, the outdoor unit and the indoor units will start up. Make sure that the preparations of all indoor units are finished (field piping, electrical wiring, air purge, ...). See installation manual of the indoor units for details.

19.2 Checklist before commissioning

- 1 After the installation of the unit, check the items listed below.
- 2 Close the unit.
- 3 Power up the unit.

<input type="checkbox"/>	You have read the complete installation and operation instructions described in the installer and user reference guide .
<input type="checkbox"/>	Installation Check that the unit is properly installed, to avoid abnormal noises and vibrations when starting up the unit.
<input type="checkbox"/>	Field wiring Check that the field wiring has been carried out according to the instructions described in the chapter " 17 Electrical installation " [▶ 36], according to the wiring diagrams and according to the applicable national wiring regulation.
<input type="checkbox"/>	Power supply voltage Check the power supply voltage on the local supply panel. The voltage MUST correspond to the voltage on the nameplate of the unit.
<input type="checkbox"/>	Earth wiring Be sure that the earth wires have been connected properly and that the earth terminals are tightened.
<input type="checkbox"/>	Insulation test of the main power circuit Using a megatester for 500 V, check that the insulation resistance of 2 MΩ or more is attained by applying a voltage of 500 V DC between power terminals and earth. NEVER use the megatester for the interconnection wiring.
<input type="checkbox"/>	Fuses, circuit breakers, or protection devices Check that the fuses, circuit breakers, or the locally installed protection devices are of the size and type specified in the chapter Specifications of standard wiring components. Be sure that neither a fuse nor a protection device has been bypassed.
<input type="checkbox"/>	Internal wiring Visually check the electrical component box and the inside of the unit for loose connections or damaged electrical components.
<input type="checkbox"/>	Pipe size and pipe insulation Be sure that correct pipe sizes are installed and that the insulation work is properly executed.
<input type="checkbox"/>	Stop valves Be sure that the stop valves are open on both liquid and gas side.
<input type="checkbox"/>	Damaged equipment Check the inside of the unit for damaged components or squeezed pipes.
<input type="checkbox"/>	Refrigerant leak Check the inside of the unit on refrigerant leakage. If there is a refrigerant leak, try to repair the leak. If the repair is unsuccessful, call your local dealer. Do not touch any refrigerant which has leaked out from refrigerant piping connections. This may result in frostbite.
<input type="checkbox"/>	Oil leak Check the compressor for oil leakage. If there is an oil leak, try to repair the leak. If the repairing is unsuccessful, call your local dealer.
<input type="checkbox"/>	Air inlet/outlet Check that the air inlet and outlet of the unit is NOT obstructed by paper sheets, cardboard, or any other material.

<input type="checkbox"/>	Additional refrigerant charge The amount of refrigerant to be added to the unit shall be written on the included "Added refrigerant" plate and attached to the rear side of the front cover.
<input type="checkbox"/>	Requirements for R32 equipment Make sure the system meets all requirements that are described in the following chapter: " 2.1 Instructions for equipment using R32 refrigerant " [▶ 6].
<input type="checkbox"/>	Field settings Make sure all field settings you want are set. See " 18.1 Making field settings " [▶ 40].
<input type="checkbox"/>	Installation date and field setting Be sure to keep record of the installation date on the sticker on the rear of the upper front panel according to EN60335-2-40 and keep record of the contents of the field setting(s).

19.3 Checklist during commissioning

<input type="checkbox"/>	To perform a BS unit test run . See the BS unit installation manual for more information.
<input type="checkbox"/>	To perform a test run .
<input type="checkbox"/>	To perform a BS/indoor unit connection check .

19.4 About the BS unit test run

The BS unit test run has to be performed on all BS units in the system, before the test run of the outdoor unit. The BS unit test run has to confirm that the required safety measures are properly installed. Even when no safety measures are required, it is necessary to perform this BS unit test run and confirm the result, because the test run of the outdoor unit checks this confirmation for all BS units in the system. See the BS unit installation and operation manual for more information.



NOTICE

It is very important that all refrigerant piping work is done before the units (outdoor, BS or indoor) are powered. When the units are powered, the expansion valves initialise. This means that the valves close.

If any part of the system had already been powered before, setting [2-21] on the outdoor unit has to be activated to open the expansion valves again.

19.5 About the system test run



NOTICE

Make sure to carry out the test run after the first installation. Otherwise, the malfunction code *U3* will be displayed on the user interface and normal operation or individual indoor unit test run cannot be carried out.

The procedure below describes the test operation of the complete system. This operation checks and judges following items:

- Check for incorrect wiring (communication check with indoor units).
- Check of the stop valves opening.
- Judgement of piping length.
- Abnormalities on indoor units cannot be checked for each unit separately. After the test operation is finished, check the indoor units one by one by performing a normal operation using the user interface. Refer to the indoor unit installation manual for more details concerning the individual test run.

19 Commissioning

INFORMATION

- It may take 10 minutes to achieve a uniform refrigerant state before the compressor starts.
- During the test operation, the refrigerant running sound or the magnetic sound of a solenoid valve may become loud and the display indication may change. These are not malfunctions.

19.5.1 To perform a test run

- Close all front panels in order to not let it be the cause of misjudgement (except the electrical component box inspection opening service cover).
- Make sure all field settings you want are set; see "18.1 Making field settings" [▶ 40].
- Turn ON the power to the outdoor unit and the connected indoor units.

NOTICE

Turn ON the power 6 hours before operation in order to have power running to the crankcase heater and to protect the compressor.

- Make sure the default (idle) situation is existing; see "18.1.4 To access mode 1 or 2" [▶ 41]. Push BS2 for 5 seconds or more. The unit will start test operation.

Result: The test operation is automatically carried out, the outdoor unit display will indicate "E01" and the indication "Test operation" and "Under centralised control" will display on the user interface of indoor units.

Steps during the automatic system test run procedure:

Step	Description
E01	Control before start up (pressure equalisation)
E02	Cooling start up control
E03	Cooling stable condition
E04	Communication check
E05	Stop valve check
E06	Pipe length check
E07	Refrigerant amount check
E09	Pump down operation
E10	Unit stop

INFORMATION

During the test operation, it is not possible to stop the unit operation from a user interface. To abort the operation, press BS3. The unit will stop after ±30 seconds.

- Check the test operation results on the outdoor unit 7-segment display.

Completion	Description
Normal completion	No indication on the 7-segment display (idle).
Abnormal completion	Indication of malfunction code on the 7-segment display. Refer to "19.5.2 Correcting after abnormal completion of the test run" [▶ 46] to take actions for correcting the abnormality. When the test operation is fully completed, normal operation will be possible after 5 minutes.

19.5.2 Correcting after abnormal completion of the test run

The test operation is only completed if there is no malfunction code displayed on the user interface or outdoor unit 7-segment display. In case of a displayed malfunction code, perform correcting actions as

explained in the malfunction code table. Carry out the test operation again and confirm that the abnormality is properly corrected.

INFORMATION

Refer to the installation manual of the indoor unit for detailed malfunction codes related to indoor units.

19.6 To perform a BS/indoor unit connection check

This test run can be performed to confirm if wiring and piping connections between indoor units and BS units are matching.

For the safe operation of the system, it is mandatory to confirm the wiring and piping connections between the indoor units and BS units. This can be done either via a thorough manual check or via the built-in automatic check.

In case group control is implemented over multiple branch ports of the same BS unit, it is not possible to directly use the built-in automatic check. Consult this chapter in the Installer and User Reference guide for extra information.

This limitation is only related to the built-in check, for normal operation, this configuration is possible.

BS/indoor automatic connection test run

Operation range for the indoor units is 20~27°C and for the outdoor units this is -5~43°C.

- Close all front panels in order to not let it be the cause of misjudgement (except the electrical component box inspection opening service cover).
- Make sure the test run is fully completed without malfunction code (see "19.5.1 To perform a test run" [▶ 46]).
- To start the BS/indoor unit connection check, make field setting [2-20]=2 (see "18.1.8 Mode 2: field settings" [▶ 42]). The unit will start the check operation.

Result: The check operation is automatically carried out, the outdoor unit display will indicate "E00" and the indication "Centralised control" and "Test run" will be displayed on the indoor unit user interface(s).

Steps during the automatic connection check procedure:

Step	Description
E00	Check ON
E01	Precooling and preheating operations
E02	Control before start-up (pressure equalisation)
E03	Four way valve initial control
E04	Heating start-up
E05	Misconnection assessment operation
E06	Pumpdown
E07	Restart standby
E08	Stop

INFORMATION

During the check operation, it is not possible to stop the unit operation from a user interface. To abort the operation, press BS3. The unit will stop after ±30 seconds.

During the check, if the following codes are on 7-segment display, the check will not continue, take actions for correcting.

Code	Description
E-2	Indoor unit is out of temperature range 20~27°C for leak detection operation.
E-3	Outdoor unit is out of temperature range -5~43°C for leak detection operation.

Code	Description
E-4	Too low pressure was noticed during leak detection operation. Restart BS/indoor unit connection check.
E-5	Indicates an indoor unit is not compatible with this function.

4 Check the results on the outdoor unit 7-segment display.

Completion	Description
Normal completion	"OK" on the 7-segment display.
Abnormal completion	Indication of malfunction code on the 7-segment display. Refer to "19.5.2 Correcting after abnormal completion of the test run" [▶ 46] to take actions for correcting the abnormality. When the check is fully completed, normal operation will be possible after 5 minutes.

20 Hand-over to the user

Once the test run is finished and the unit operates properly, make sure the following is clear for the user:

- Make sure that the user has the printed documentation and ask him/her to keep it for future reference. Inform the user that he can find the complete documentation at the URL mentioned earlier in this manual.
- Explain the user how to properly operate the system and what to do in case of problems.
- Show the user what to do for the maintenance of the unit.

21 Maintenance and service



NOTICE

Maintenance MUST be done by an authorised installer or service agent.

We recommend performing maintenance at least once a year. However, applicable legislation might require shorter maintenance intervals.



NOTICE

Applicable legislation on **fluorinated greenhouse gases** requires that the refrigerant charge of the unit is indicated both in weight and CO₂ equivalent.

Formula to calculate the quantity in CO₂ equivalent tonnes: GWP value of the refrigerant × total refrigerant charge [in kg] / 1000

21.1 Maintenance safety precautions



DANGER: RISK OF ELECTROCUTION



DANGER: RISK OF BURNING/SCALDING



WARNING

Prior to start working on systems containing flammable refrigerant, safety checks are necessary to ensure that the risk of ignition is minimised. Therefore, some instructions should be followed.

Please refer to the service manual for more information.



NOTICE: Risk of electrostatic discharge

Before performing any maintenance or service work, touch a metal part of the unit in order to eliminate static electricity and to protect the PCB.

21.1.1 To prevent electrical hazards

When performing service to inverter equipment:

- Do NOT open the electrical component box cover for 10 minutes after turning off the power supply.
- Measure the voltage between terminals on the terminal block for power supply with a tester and confirm that the power supply is shut off. In addition, measure points as shown in the figure, with a tester and confirm that the voltage of the capacitor in the main circuit is less than 50 V DC. If the voltage measured is still higher than 50 V DC, discharge the capacitors in a safe manner by using a dedicated capacitor discharge pen to avoid possibility of sparking.

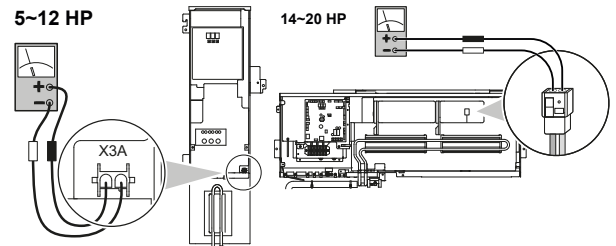

- Pull out junction connectors X1A, X2A for the fan motors in the outdoor unit before starting service operation on the inverter equipment. Be careful NOT to touch the live parts. (If a fan rotates due to strong wind, it may store electricity in the capacitor or in the main circuit and cause electrical shock.)
- After the service is finished, plug the junction connector back in. Otherwise the malfunction code E 7 will be displayed on the user interface or on the outdoor unit 7-segment display and normal operation will NOT be performed.

For details refer to the wiring diagram labelled on the back of the electrical component box cover.

Pay attention to the fan. It is dangerous to inspect the unit while the fan is running. Make sure to turn off the main switch and to remove the fuses from the control circuit located in the outdoor unit.

21.2 Checklist for yearly maintenance of the outdoor unit

Check the following at least once a year:

- Heat exchanger

The heat exchanger of the outdoor unit can get blocked up due to dust, dirt, leaves, etc. It is recommended to clean the heat exchanger yearly. A blocked heat exchanger can lead to too low pressure or too high pressure leading to worse performance.

21.3 About service mode operation

Refrigerant recovery operation/vacuumping operation is possible by applying setting [2-21]. Refer to "18.1 Making field settings" [▶ 40] for details how to set mode 2.

When vacuuming/recovery mode is used, check very carefully what should be vacuumed/recovered before starting. See installation manual of the indoor unit for more information about vacuuming and recovery.

21.3.1 To use vacuum mode

- When the unit is at standstill, set the unit in [2-21]=1.

22 Troubleshooting

Result: When confirmed, the indoor and outdoor unit expansion valves will fully open. At that moment the 7-segment display indication= $E3$ and the user interface of all indoor units indicate TEST (test operation) and  (external control) and the operation will be prohibited.

- 2 Evacuate the system with a vacuum pump.
- 3 Press BS3 to stop vacuuming mode.

21.3.2 To recover refrigerant

This should be done with a refrigerant recovery unit. Follow the same procedure as for vacuuming method.



DANGER: RISK OF EXPLOSION

Pump down – Refrigerant leakage. If you want to pump down the system, and there is a leak in the refrigerant circuit:

- Do NOT use the unit's automatic pump down function, with which you can collect all refrigerant from the system into the outdoor unit. **Possible consequence:** Self-combustion and explosion of the compressor because of air going into the operating compressor.
- Use a separate recovery system so that the unit's compressor does NOT have to operate.



NOTICE

Make sure to NOT recover any oil while recovering refrigerant. **Example:** By using an oil separator.

22 Troubleshooting



CAUTION

See "2 Specific installer safety instructions" [▶ 4] to make sure troubleshooting complies with all safety regulations.

22.1 Solving problems based on error codes

In case of a displayed malfunction code, perform correcting actions as explained in the malfunction code table.

After correcting the abnormality, press BS3 to reset the malfunction code and retry operation.

The malfunction code which is displayed on the outdoor unit will indicate a main malfunction code and a sub code. The sub code indicates more detailed information about the malfunction code. The malfunction code will be displayed intermittent.

Example:

Code	Example
Main code	$E3$
Sub code	-01

With an interval of 1 second, the display will switch between main code and sub code.



INFORMATION

See the service manual for:

- The complete list of error codes
- A more detailed troubleshooting guideline for each error

22.1.1 Error codes: Overview

In case other error codes appear, contact your dealer.

Main code	Sub code		Cause	Solution	SVEO ^(a)	SVS ^(b)
	Master	Slave 1				
$R0$		-11	The R32 sensor in one of the indoor units has detected a refrigerant leak ^(c)	Possible R32 leak. The BS unit will close the shut-off valves of the branch pipe port to which the corresponding indoor unit is connected. Indoor units on this branch pipe port will be out of operation until the leak is repaired. Refer to service manual for more information.	✓	✓
		-20	The R32 sensor in one of the BS unit has detected a refrigerant leak	Possible R32 leak. The BS unit will close all of its shut-off valves and triggers the ventilation system of the BS unit. The system goes in locked status. Service is needed to repair the leak and activate the system. Refer to the service manual for more information.	✓	✓
		ICH	Safety system error (leak detection) ^(c)	An error related to the safety system occurred. Refer to the service manual for more information.	✓	

Main code	Sub code		Cause	Solution	SVEO ^(a)	SVS ^(b)
	Master	Slave 1				
CH	-01		R32 sensor malfunction in one of the indoor units ^(c)	Check connection on PCB or actuator. The system will continue operating, but the indoor unit in scope will stop operating. Refer to the service manual for more information.		✓
	-02		R32 sensor end of lifetime in one of the indoor units ^(c)	One of the sensors is at the end of lifetime and must be replaced. Refer to the service manual for more information.		
	-05		R32 sensor end of lifetime < 6 months in one of the indoor units ^(c)	One of the sensors is almost at the end of lifetime and must be replaced. Refer to the service manual for more information.		
	-10		Waiting for indoor unit R32 sensor replacement input ^(c)	Refer to the service manual for more information.		
	-20		Waiting for BS unit replacement input	Refer to the service manual for more information.		
	-21		R32 sensor malfunction in one of the BS units	Check connection on PCB or actuator. The system will continue operation, but BS unit in scope will stop operating. Refer to the service manual for more information.		✓
	-22		R32 sensor end of lifetime less than 6 months in one of the BS units	One of the sensors is at the end of lifetime (for CH-22: almost) and must be replaced.		
	-23		R32 sensor end of lifetime in one of the BS units	Refer to the service manual for more information.		
E2	-01	-02	Earth leakage detector activated	Restart the unit. If the problem reoccurs, contact your dealer.	✓	
	-05	-07	Earth leakage detector malfunction: open circuit) - A1P (X101A)	Check connection on PCB or actuator.	✓	
E3	-01	-03	High pressure switch was activated (S1PH) – main PCB (X2A)	Check stop valve situation or abnormalities in (field) piping or airflow over air cooled coil.	✓	
	-02	-04	<ul style="list-style-type: none"> ▪ Refrigerant overcharge ▪ Stop valve closed 	<ul style="list-style-type: none"> ▪ Check refrigerant amount+recharge unit. ▪ Open stop valves 	✓	
	-13	-14	Stop valve closed (liquid)	Open liquid stop valve.	✓	
	-18		<ul style="list-style-type: none"> ▪ Refrigerant overcharge ▪ Stop valve closed 	<ul style="list-style-type: none"> ▪ Check refrigerant amount+recharge unit. ▪ Open stop valves. 	✓	
E4	-01	-02	Low pressure malfunction: <ul style="list-style-type: none"> ▪ Stop valve closed ▪ Refrigerant shortage ▪ Indoor unit malfunction 	<ul style="list-style-type: none"> ▪ Open stop valves. ▪ Check refrigerant amount+recharge unit. ▪ Check the user interface's display or interconnection wiring between the outdoor unit and the indoor unit. 	✓	
E9	-01	-05	Electronic expansion valve malfunction (upper heat exchanger) (Y1E) – main PCB (X21A)	Check connection on PCB or actuator.	✓	
	-04	-07	Electronic expansion valve malfunction (inverter cooling) (Y5E) – main PCB (X23A)	Check connection on PCB or actuator.	✓	
	-03	-05	Electronic expansion valve malfunction (lower heat exchanger) (Y3E) – main PCB (X22A)	Check connection on PCB or actuator	✓	
	-25	-27	Electronic expansion valve malfunction (receiver gas) (Y4E) – main PCB (X25A)	Check connection on PCB or actuator.	✓	
	-29	-34	Electronic expansion valve malfunction (subcool heat exchanger) (Y2E) – main PCB (X26A)	Check connection on PCB or actuator.	✓	
	-30	-35	Electronic expansion valve malfunction (liquid injection)(Y7E) - sub PCB (X9A)	Check connection on PCB or actuator.	✓	

22 Troubleshooting

Main code	Sub code		Cause	Solution	SVEO ^(a)	SVS ^(b)
	Master	Slave 1				
F3	-01	-03	Discharge temperature too high (R21T) – main PCB (X33A): <ul style="list-style-type: none"> Stop valve closed Refrigerant shortage 	<ul style="list-style-type: none"> Open stop valves. Check refrigerant amount+recharge unit. 	✓	
	-20	-21	Compressor casing temperature too high (R15T) – main PCB (X33A): <ul style="list-style-type: none"> Stop valve closed Refrigerant shortage 	<ul style="list-style-type: none"> Open stop valves. Check refrigerant amount+recharge unit. 	✓	
F6	-02		<ul style="list-style-type: none"> Refrigerant overcharge Stop valve closed 	<ul style="list-style-type: none"> Check refrigerant amount+recharge unit. Open stop valves. 	✓	
H9	-01	-02	Ambient temperature sensor malfunction (R1T) – main PCB (X18A)	Check connection on PCB or actuator.	✓	
J3	-16	-22	Discharge temperature sensor malfunction (R21T): open circuit – main PCB (X33A)	Check connection on PCB or actuator.	✓	
	-17	-23	Discharge temperature sensor malfunction (R21T): short circuit - main PCB (X33A)	Check connection on PCB or actuator.	✓	
	-47	-49	Compressor casing temperature sensor malfunction (R15T): open circuit - main PCB (X33A)	Check connection on PCB or actuator.	✓	
	-48	-50	Compressor casing temperature sensor malfunction (R15T): short circuit - main PCB (X33A)	Check connection on PCB or actuator.	✓	
J5	-01	-03	Suction compressor temperature sensor (R12T) – main PCB (X35A)	Check connection on PCB or actuator.	✓	
	-18	-19	Suction temperature sensor (R10T) – main PCB (X29A)	Check connection on PCB or actuator.	✓	
J6	-01	-02	Heat exchanger deicer temperature sensor (R11T) – main PCB (X35A)	Check connection on PCB or actuator.	✓	
	-08	-09	Upper heat exchanger – gas - temperature sensor (R8T) – main PCB (X29A)	Check connection on PCB or actuator.	✓	
	-11	-12	Lower heat exchanger – gas - temperature sensor (R9T) main PCB (X29A)	Check connection on PCB or actuator.	✓	
J7	-01	-02	Liquid main - temperature sensor (R3T) – main PCB (X30A)	Check connection on PCB or actuator.	✓	
	-06	-07	Subcool heat exchanger – liquid - temperature sensor (R7T) - main PCB (X30A)	Check connection on PCB or actuator.	✓	
	-18	-19	Subcool heat exchanger – liquid - temperature sensor (R16T) - main PCB (X35A)	Check connection on PCB or actuator.	✓	
J8	-01	-02	Upper heat exchanger – liquid -temperature sensor (R4T) - main PCB (X30A)	Check connection on PCB or actuator.	✓	
	-08	-09	Lower heat exchanger – liquid - temperature sensor (R5T) - main PCB (X30A)	Check connection on PCB or actuator.	✓	
J9	-01	-02	Subcool heat exchanger – gas - temperature sensor (R6T) – main PCB (X30A)	Check connection on PCB or actuator.	✓	
	-11	-12	Receiver gas temperature sensor (R13T) – main PCB (X46A)	Check connection on PCB or actuator.	✓	
JR	-06	-08	High pressure sensor malfunction (S1NPH): open circuit - main PCB (X32A)	Check connection on PCB or actuator.	✓	
	-07	-09	High pressure sensor malfunction (S1NPH): short circuit - main PCB (X32A)	Check connection on PCB or actuator.	✓	
JC	-06	-08	Low pressure sensor malfunction (S1NPL): open circuit - main PCB (X31A)	Check connection on PCB or actuator.	✓	
	-07	-09	Low pressure sensor malfunction (S1NPL): short circuit - main PCB (X31A)	Check connection on PCB or actuator.	✓	

Main code	Sub code		Cause	Solution	SVEO ^(a)	SVS ^(b)
	Master	Slave 1				
LC	-14	-15	Transmission outdoor unit - inverter: INV1 transmission trouble - main PCB (X20A, X28A, X40A)	Check connection.	✓	
	-19	-20	Transmission outdoor unit - inverter: FAN1 transmission trouble - main PCB (X20A, X28A, X40A)	Check connection.	✓	
	-24	-25	Transmission outdoor unit - inverter: FAN2 transmission trouble - main PCB (X20A, X28A, X40A)	Check connection.	✓	
	-33	-34	Transmission main PCB – sub PCB – main PCB (X20A), sub PCB (X2A, X3A)	Check connection.	✓	
PI	-01	-02	INV1 unbalanced power supply voltage	Check if power supply is within range.		
U1	-01	-05	Reversed power supply phase malfunction	Correct phase order.	✓	
	-04	-06	Reversed power supply phase malfunction	Correct phase order.	✓	
U2	-01	-08	INV1 voltage power shortage	Check if power supply is within range.	✓	
	-02	-09	INV1 power phase loss	Check if power supply is within range.	✓	
U3	-03		Malfunction code: system test run not yet executed (system operation not possible)	Execute system test run.		
	-04		An error occurred during the test run	Re-execute the test run.	✓	
	-05, -06		Test run aborted	Re-execute the test run.	✓	
	-07, -08		Test run aborted due to communication issues	Check the communication wires and re-execute the test run.	✓	
	-12		Commissioning of BS unit safety system is not completed	Complete commissioning of BS unit safety system. Refer to BS unit manual for more information.	✓	
U4	-03		Indoor unit communication error	Check user interface connection.	✓	
U7	-03, -04		Malfunction code: faulty wiring to Q1/Q2	Check Q1/Q2 wiring.	✓	
	-11		Too many indoor units are connected to F1/F2 line	Check indoor unit amount and total capacity connected.	✓	
U9	-01		Warning because there is an error on another unit (indoor/BS unit)	Check if other indoor units/BS units have a malfunction and confirm if indoor unit mix is allowed.	✓	
UR	-03		Connection malfunction over indoor units or type mismatch	Check if other indoor units have a malfunction and confirm if indoor unit mix is allowed.	✓	
	-18		Connection malfunction over indoor units or type mismatch	Check if other indoor units have a malfunction and confirm if indoor unit mix is allowed.	✓	
	-31		Wrong unit combination (multi system)	Check if unit types are compatible.	✓	
	-20		Wrong outdoor unit connected	Disconnect the outdoor unit.	✓	
	-27		No BS unit connected	Connect a BS unit.	✓	
	-28		Old BS unit connected	Disconnect the BS unit.	✓	
	-52		BS unit refrigerant type abnormality	Check BS unit refrigerant type	✓	
	-53		BS unit DIP switch abnormality	Check the DIP switches of the BS unit.	✓	
UF	-01		Mismatch between wiring path and piping path during test run	Mistake detected during BS unit and indoor unit connection check (see "19.6 To perform a BS/indoor unit connection check" [▶ 46]). Confirm wiring between indoors and BS units. Refer to BS unit manual for correct way of wiring.	✓	
	-18					
UH	-01		Auto address malfunction (inconsistency)	Check if interconnected unit amount matches with powered unit amount (by monitor mode) or wait until initialisation is finished.	✓	
UJ	-40		Maintenance warning (ventilation fan)	BS unit ventilation needs maintenance check. Refer to the BS unit manual for more information.	✓	

Leak detection function related error codes

22 Troubleshooting

Main code	Sub code		Cause	Solution	SVEO ^(a)	SVS ^(b)
	Master	Slave 1				
E-1	—		Unit is not prepared to execute leak detection operation	Refer to requirements to be able to execute leak detection operation.	✓	
E-2	—		Indoor unit is out of temperature range 20~32°C for leak detection operation.	Retry when ambient conditions are satisfied.	✓	
E-3	—		Outdoor unit is out of temperature range 4~43°C for leak detection operation.	Retry when ambient conditions are satisfied.	✓	
E-4	—		Too low pressure was noticed during leak detection operation	Restart leak detection operation.	✓	
E-5	—		Indicates an indoor unit which is not compatible with leak detection functionality is installed	Use VRV R32 compatible indoor units, see engineering databook for unit selection.	✓	

^(a) The SVEO terminal provides an electrical contact that closes in case the indicated error occurs.

^(b) The SVS terminal provides an electrical contact that closes in case the indicated error occurs.

^(c) The error code is only shown on the user interface of the indoor unit where the error occurs.

22.2 Refrigerant leak detection system

Normal operation

During normal operation, the alarm only and supervisor remote controller have no functionality. The screen of the remote controller in alarm only and supervisor mode will be off. Operation of the remote controller can be checked by pushing the  button to open the installer menu.

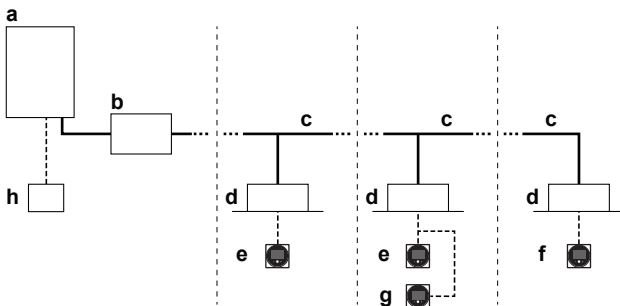

- a Heat recovery outdoor unit
- b Branch selector (BS)
- c Refrigerant piping
- d VRV direct expansion (DX) indoor unit
- e Remote controller in normal mode
- f Remote controller in alarm only mode
- g Remote controller in supervisor mode (mandatory in some situations)
- h Centralised controller (optional)

Note: During start-up of the system, the mode of the remote control can be verified from the screen.

Leak detection operation

- 1 If the R32 sensor in the indoor unit detects a refrigerant leak:
 - The user will be warned by both audible and visible signals of the remote controller of the leaking indoor unit (and the supervisor remote controller, if applicable).
 - At the same time the BS unit will close the shut-off valves of the corresponding branch pipe in order to reduce the amount of refrigerant in the indoor system.
 - After the operation, the indoor units of the port where the leak was detected will be out of operation and display an error. The rest of the system will continue operation.
- 2 If the R32 sensor in the BS unit detects a refrigerant leak:
 - The BS unit will close all of its shut-off valves and triggers the ventilation system (if equipped) of the BS unit to evacuate the leaking refrigerant.
 - After the operation, the system will go in locked state and the remote controllers will display an error. Service is needed to repair the leak and activate the system. Refer to the service manual for more information.

Feedback of the remote controller after leak detection operation will depend on its mode.



WARNING

The unit is equipped with a refrigerant leak detection system for safety.

To be effective, the unit **MUST** be electrically powered at all times after installation, except for maintenance.

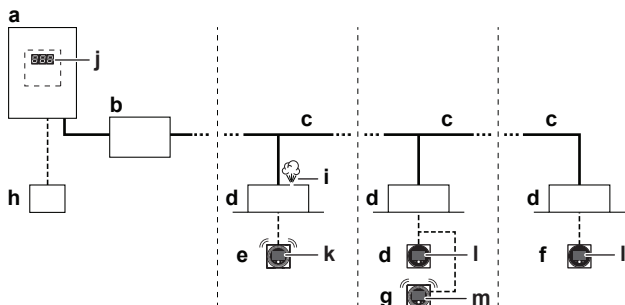

- a Heat recovery outdoor unit
- b Branch selector (BS)
- c Refrigerant piping
- d VRV direct expansion (DX) indoor unit
- e Remote controller in normal mode
- f Remote controller in alarm only mode
- g Remote controller in supervisor mode (mandatory in some situations)
- h Centralised controller (optional)
- i Refrigerant leak
- j Outdoor unit error code on 7-segment display

- k Error code 'A0-11' and audible alarm and red warning signal is generated from this remote controller.
- l Error code 'U9-02' is displayed on this remote controller. No alarm or warning lights.
- m Error code 'A0-11' and audible alarm and red warning signal is generated from this **supervisor** remote controller. The unit **address** is displayed on this remote controller.

Note: It is possible to stop the leak detection alarm from the remote controller and from the app. To stop the alarm from the remote controller, press **+** for 3 seconds.

Note: Leak detection will trigger SVS output. For more information, see "17.8 To connect the external outputs" [p. 39].

Note: An optional output PCB for the indoor unit can be added to provide output for external device. The output PCB will trigger in case a leak is detected. For exact model name see option list of the indoor unit. For more information about this option, refer to the installation manual of the optional output PCB

Note: Some centralised controllers can also be used as supervisor remote controller. For further details on installation, please refer to the installation manual of the centralised controllers.

NOTICE

The R32 refrigerant leakage sensor is a semiconductor detector which may incorrectly detect substances other than R32 refrigerant. Avoid using chemical substances (e.g. organic solvents, hair spray, paint) in high concentrations, in the close proximity of the indoor unit because this may cause misdetection by the R32 refrigerant leakage sensor.

23 Disposal

NOTICE

Do NOT try to dismantle the system yourself: dismantling of the system, treatment of the refrigerant, oil and other parts MUST comply with applicable legislation. Units MUST be treated at a specialised treatment facility for reuse, recycling and recovery.

24 Technical data

- A **subset** of the latest technical data is available on the regional Daikin website (publicly accessible).
- The **full set** of latest technical data is available on the Daikin Business Portal (authentication required).

24.1 Service space: Outdoor unit

Make sure the space around the unit is adequate for servicing and the minimum space for air inlet and air outlet is available (refer to the figure below and choose one of the possibilities).

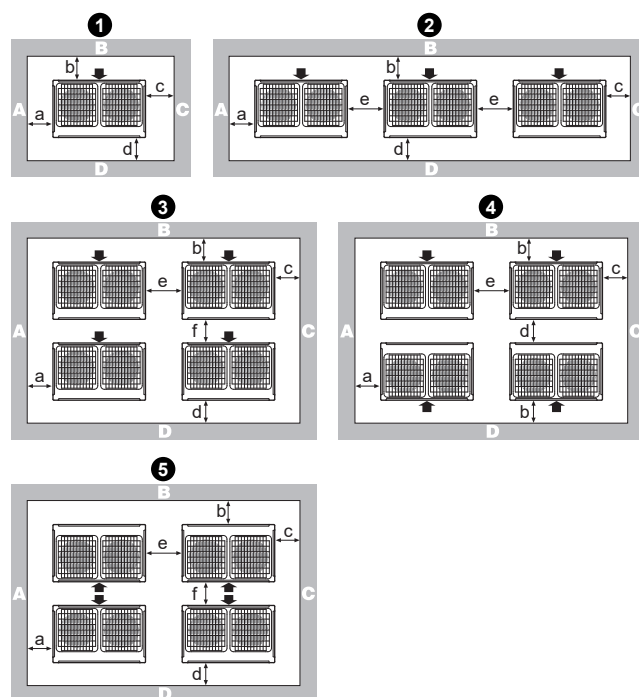

Layout	A+B+C+D		A+B
	Possibility 1	Possibility 2	
1	a ≥ 10 mm b ≥ 300 mm c ≥ 10 mm d ≥ 500 mm	a ≥ 50 mm b ≥ 100 mm c ≥ 50 mm d ≥ 500 mm	a ≥ 200 mm b ≥ 300 mm
2	a ≥ 10 mm b ≥ 300 mm c ≥ 10 mm d ≥ 500 mm e ≥ 20 mm	a ≥ 50 mm b ≥ 100 mm c ≥ 50 mm d ≥ 500 mm e ≥ 100 mm	a ≥ 200 mm b ≥ 300 mm e ≥ 400 mm
3	a ≥ 10 mm b ≥ 300 mm c ≥ 10 mm d ≥ 500 mm e ≥ 20 mm f ≥ 600 mm	a ≥ 50 mm b ≥ 100 mm c ≥ 50 mm d ≥ 500 mm e ≥ 100 mm f ≥ 500 mm	—
4	a ≥ 10 mm b ≥ 300 mm c ≥ 10 mm d ≥ 500 mm e ≥ 20 mm	a ≥ 50 mm b ≥ 100 mm c ≥ 50 mm d ≥ 500 mm e ≥ 100 mm	—
5	a ≥ 10 mm b ≥ 500 mm c ≥ 10 mm d ≥ 500 mm e ≥ 20 mm f ≥ 900 mm	a ≥ 50 mm b ≥ 500 mm c ≥ 50 mm d ≥ 500 mm e ≥ 100 mm f ≥ 600 mm	—

24 Technical data

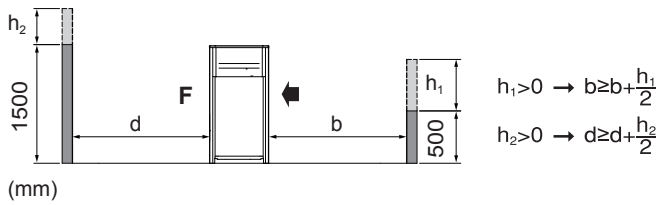

(mm)

ABCD Sides along the installation site with obstacles
F Front side
 Suction side

- In case of an installation site where sides A+B+C+D have obstacles, the wall heights of sides A+C have no impact on service space dimensions. Refer to the figure above for impact of wall heights of sides B+D on service space dimensions.
- In case of an installation site where only the sides A+B have obstacles, the wall heights have no influence on any indicated service space dimensions.



INFORMATION

The service space dimensions in above figure are based on cooling operation at 35°C ambient temperature (standard conditions).



INFORMATION

Further specifications can be found in the technical engineering data.

24.2 Piping diagram: Outdoor unit

Piping diagram: 5~12 HP

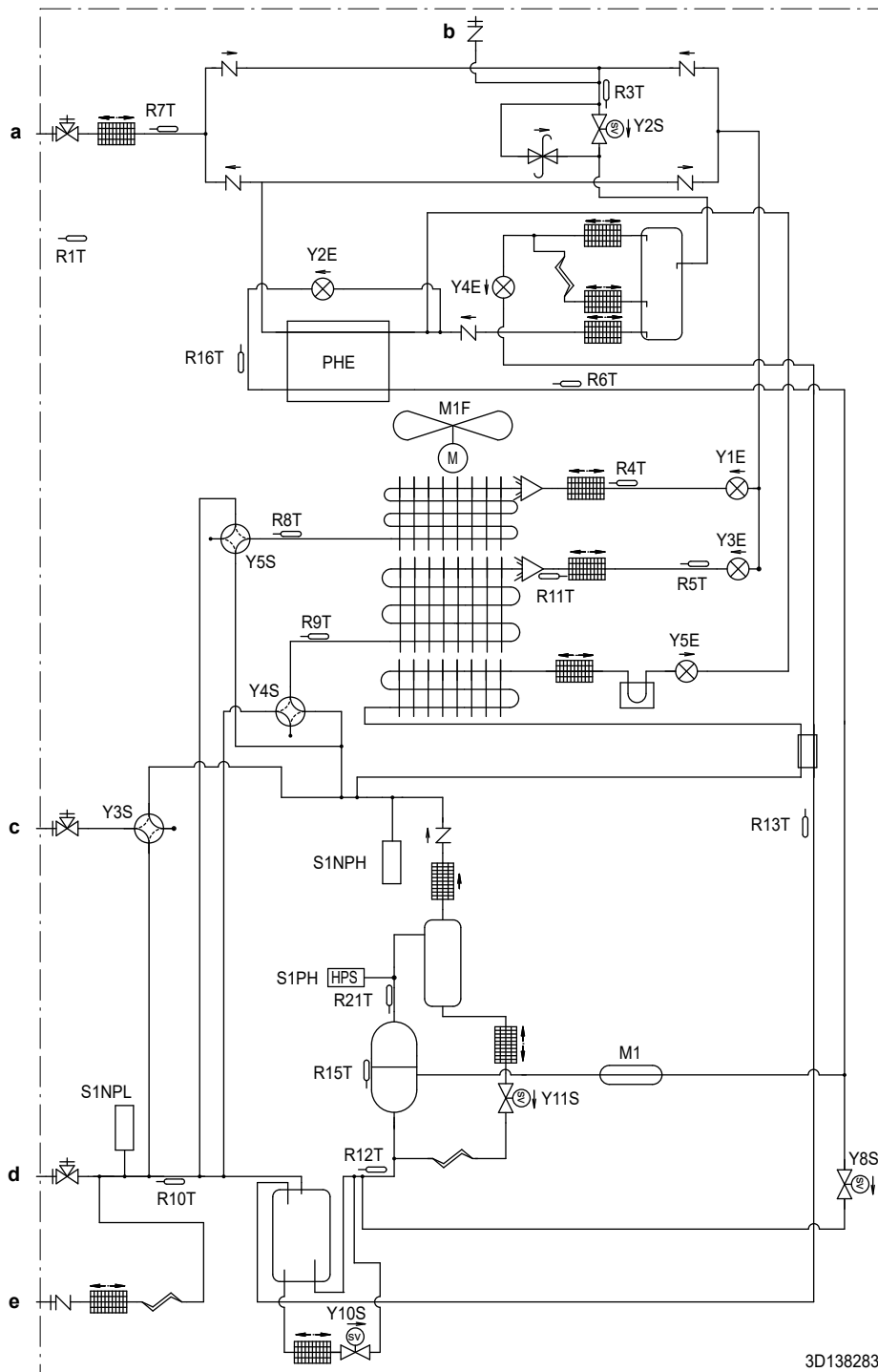

- a Stop valve (liquid)
- b Service port
- c Stop valve (high pressure/low pressure)
- d Stop valve (gas)
- e Charge port





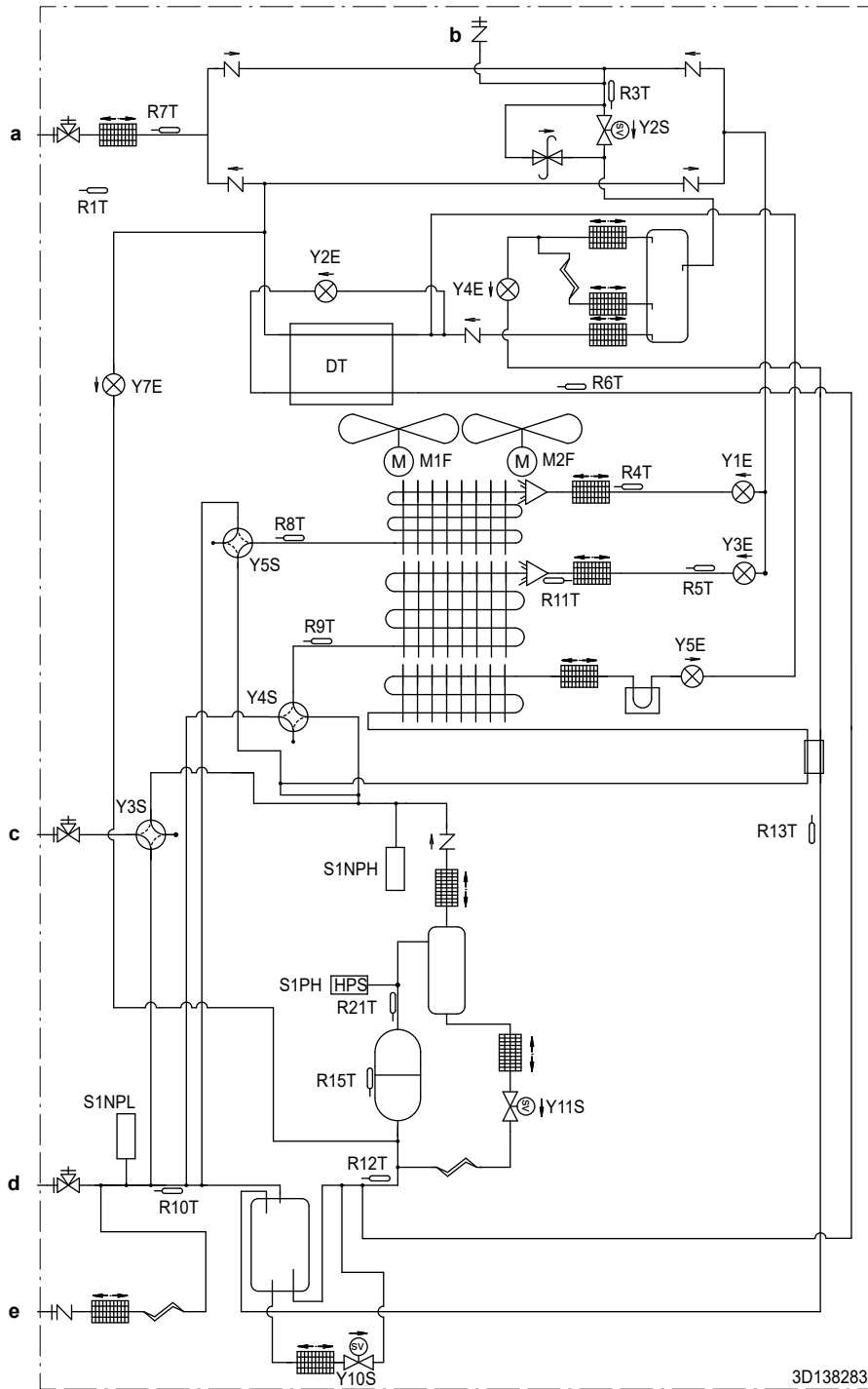



















24 Technical data

Piping diagram: 14~20 HP



3D138283

- a Stop valve (liquid)
- b Service port
- c Stop valve (high pressure/low pressure)
- d Stop valve (gas)
- e Charge port

	Charge port / Service port
	Stop valve
	Filter
	Check valve
	Pressure relief valve
	Thermistor
	Solenoid valve
	Heat sink (PCB)
	Capillary tube
	Expansion valve
	4-way valve
	Propeller fan
	High pressure switch
	*PL: low pressure sensor
	*PH: high pressure sensor
	Oil separator
	Accumulator
	Heat exchanger
	Compressor
	PHE: plate heat exchanger
	DT: double tube heat exchanger
	Distributor
	Liquid receiver
	Muffler

24.3 Wiring diagram: Outdoor unit

Refer to the wiring diagram sticker on the unit. The abbreviations used are listed below:







i INFORMATION

The wiring diagram on the outdoor unit is only for the outdoor unit. For the indoor unit or optional electrical components, refer to the wiring diagram of the indoor unit.

- 1 Symbols (see below).
- 2 Refer to the installation or service manual on how to use BS1~BS3 push buttons and DS1~DS2 switches.
- 3 Do NOT operate the unit by short-circuiting protection device S1PH.
- 4 Refer to the installation manual for connecting indoor–outdoor interconnection F1-F2 and outdoor-multi interconnection Q1-Q2.
- 5 When using the central control system, connect outdoor–outdoor interconnection F1-F2.
- 6 The capacity of the contact is 220~240V AC – 0.5 A (rush current needs 3 A or less).

- 7 Use dry contact for micro current (10 mA or less, 15 V DC).
- 8 When using the optional adapter, refer to the installation manual of the optional adapter.

Symbols:

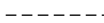
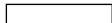
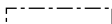
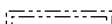
	Field wiring
	Terminal block
	Connector
	Terminal
	Protective earth
	Noiseless earth
	Earth wiring
	Field supply
	PCB
	Switch box
	Option

Colours:

BLK	Black
RED	Red
BLU	Blue
WHT	White
GRN	Green

Legend for wiring diagram

A1P	Printed circuit board (main)
A2P	Printed circuit board (noise filter)
A3P	Printed circuit board (inverter)
A4P	Printed circuit board (fan)
A5P (14~20 HP only)	Printed circuit board (fan)
A6P (14~20 HP only)	Printed circuit board (sub)
BS1~BS3 (A1P)	Push button switch (MODE, SET, RETURN)
DS1, DS2 (A1P)	DIP switch
E1HC	Crankcase heater
E3H	Bottom plate heater
F1U (A1P)	Fuse (T 10 A / 250 V)
F1U (A6P) (14~20 HP only)	Fuse (T 3.15 A / 250 V)
F1U, F2U	Fuse (T 1 A / 250 V)
F3U	Field fuse
F101U (A4P)	Fuse
HAP (A*P)	Pilot lamp (service monitor is green)
K*R (A*P)	Relay on PCB
L1R	Reactor
M1C	Motor (compressor)
M1F	Motor (fan)
M2F (14~20 HP only)	Motor (fan)
Q1DI	Earth leakage circuit breaker
R1T	Thermistor (air)
R3T	Thermistor (liquid, main)
R4T	Thermistor (heat exchanger, liquid pipe upper)
R5T	Thermistor (heat exchanger, liquid pipe lower)

25 Glossary

R6T	Thermistor (subcool heat exchanger gas)
R7T	Thermistor (subcool heat exchanger liquid)
R8T	Thermistor (heat exchanger, gas upper)
R9T	Thermistor (heat exchanger, gas lower)
R10T	Thermistor (suction)
R11T	Thermistor (heat exchanger, de-icer)
R12T	Thermistor (suction compressor)
R13T	Thermistor (receiver gas)
R15T	Thermistor (M1C body)
R16T (5~12 HP only)	Thermistor (gas injection)
R21T	Thermistor (M1C discharge)
S1NPH	High pressure sensor
S1NPL	Low pressure sensor
S1PH	High pressure switch
SEG1~SEG3 (A1P)	7-segment display
SFB	Mechanical ventilation error input
T1A	Current sensor
X*A	Connector
X*M	Terminal strip
Y1E	Electronic expansion valve (heat exchanger upper)
Y2E	Electronic expansion valve (subcool heat exchanger)
Y3E	Electronic expansion valve (heat exchanger lower)
Y4E	Electronic expansion valve (receiver gas)
Y5E	Electronic expansion valve (inverter cooling)
Y7E (14~20 HP only)	Electronic expansion valve (liquid injection)
Y2S	Solenoid valve (liquid pipe)
Y3S	Solenoid valve (high pressure/low pressure gas pipe)
Y4S	Solenoid valve (heat exchanger lower)
Y5S	Solenoid valve (heat exchanger upper)
Y8S (5~12 HP only)	Solenoid valve (gas injection)
Y10S	Solenoid valve (accu oil return)
Y11S	Solenoid valve (M1C oil return)
Y13S	Error operation output (SVEO)
Y14S	Leak sensor output (SVS)
Z*C	Noise filter (ferrite core)

Service company

Qualified company which can perform or coordinate the required service to the product.

Installation manual

Instruction manual specified for a certain product or application, explaining how to install, configure and maintain it.

Operation manual

Instruction manual specified for a certain product or application, explaining how to operate it.

Maintenance instructions

Instruction manual specified for a certain product or application, which explains (if relevant) how to install, configure, operate and/or maintain the product or application.

Accessories

Labels, manuals, information sheets and equipment that are delivered with the product and that need to be installed according to the instructions in the accompanying documentation.

Optional equipment

Equipment made or approved by Daikin that can be combined with the product according to the instructions in the accompanying documentation.

Field supply

Equipment NOT made by Daikin that can be combined with the product according to the instructions in the accompanying documentation.

25 Glossary

Dealer

Sales distributor for the product.

Authorised installer

Technical skilled person who is qualified to install the product.

User

Person who is owner of the product and/or operates the product.

Applicable legislation

All international, European, national and local directives, laws, regulations and/or codes that are relevant and applicable for a certain product or domain.



ERC



4P684060-1 B 0000000

Copyright 2022 Daikin

DAIKIN EUROPE N.V.

Zandvoordestraat 300, B-8400 Oostende, Belgium

4P684060-1B 2023.07