

VRF inverter multi-system Air-Conditioners

KXZ

High Performance
Air-Conditioning

2020



50Hz

20KX02E
ASIA

High Performance Air-Conditioning 2020



KXZ

The Mitsubishi Heavy Industries Thermal Systems KXZ VRF series delivers high performance in cooling and heating for all commercial applications. It offers the highest level of design flexibility, improved efficiency as well as enhanced operational functions.



Line Up



Micro model



KXZ Lite



KXZ

RC-EX3A

Simple use with advanced setting Remote control



Contents

Introduction	4~29
Outdoor units	30~65
Micro model	30~33
KXZ Lite	34·35
KXZ Standard series	36~43
KXZ Hi-COP series	44~47
Corrosion Protection Treatment series	48~53
Water cooled series	54·55
High head series	56~59
Refresh series	60·61
Indoor units	66~105
EEV-KIT	106·107
Control systems	108~117



KXZ system is the best air conditioning solution for "Sophisticated" buildings

KX VRF series delivers high cooling/heating performance for all commercial applications.



High Efficiency & Comfort

- High energy efficiency with advanced technology
- Energy saving control by VTCC (Variable Temperature & Capacity Control)
- Individual, centralized and customized comfort control

Design Flexibility

- Long piping length and wide limitation of piping
- Various indoor units to each application
- Easy selection and design software

Easy & Customized Control

- Individual advanced control by wired and wireless remote controller
- Various options for BMS & Centralized controller

Good Serviceability

- Easy access for maintenance
- Engineering and monitoring tool available

"Micro series" for small offices, shops and residential applications

Industry leading compact design, energy efficiency, and high reliability from our high technology



Specific cases of VRF system installation from Mitsubishi Heavy Industries Thermal Systems

Case study: Hotel and Leisure



VRF heat recovery systems from Mitsubishi Heavy Industries Thermal Systems KX range are part of the exacting specification for luxury hotels and airport-style bus station. Mitsubishi Heavy Industries Thermal Systems VRF systems feature advanced inverter technology which adjusts compressor output to match the cooling or heating demands of the indoor units to save energy and eliminate temperature fluctuations. Simultaneous heating or cooling can be provided in different areas as required, with heat gain in sunnier, south facing rooms providing useful energy for rooms on the cooler, shadier side of the buildings.



Case study: Education



A VRF system with inverter control from Mitsubishi Heavy Industries Thermal Systems is helping to make Crossways Academy in Lewisham a cool place to learn for 500 students. Comfortable temperatures need to be maintained as economically as possible in rooms where large numbers of students will enter or leave at the same time. IT equipment being switched on and off and the use of electric blinds to control glare will all contribute to substantial fluctuations in heat load. A VRF KX system from Mitsubishi Heavy Industries Thermal Systems provides an ideal solution. Much of the building was designed to rely on natural ventilation, with windows operated electronically. The air conditioning system is linked to this control system to close down when windows are opened. Mitsubishi Heavy Industries Thermal Systems KX is particularly appropriate for many such retrofit applications.





KXZ

The KXZ product lineup has been extended to offer solutions delivering up to 60 horsepower (60HP) when using a combination of 3 outdoor units. Furthermore with the addition of the Hi-COP series, installation options have been greatly increased.

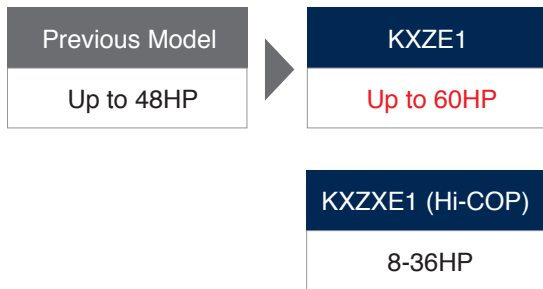

By combining 3 outdoor units 60HP can be achieved

Heat pump systems

The heat pump systems operate with 2 inter-connecting pipes, thus commonly referred to as a '2-pipe system'.

These systems provide either a heating or cooling operation to all indoor units and are suitable for a wide range of applications from an individual apartment to an entire multi storey building, especially where there are significant open plan areas to be controlled.

The range starts with a 11.2kW cooling capacity, up to 20HP with 56.0kW cooling capacity. Outdoor units can also be "twinned" or "tripled" providing up to 60HP/168.0kW on a single system.

The range has a total piping length of 1000m (KXZ) and the furthest indoor unit can be connected up to 160m (KXZ) from the outdoor unit.

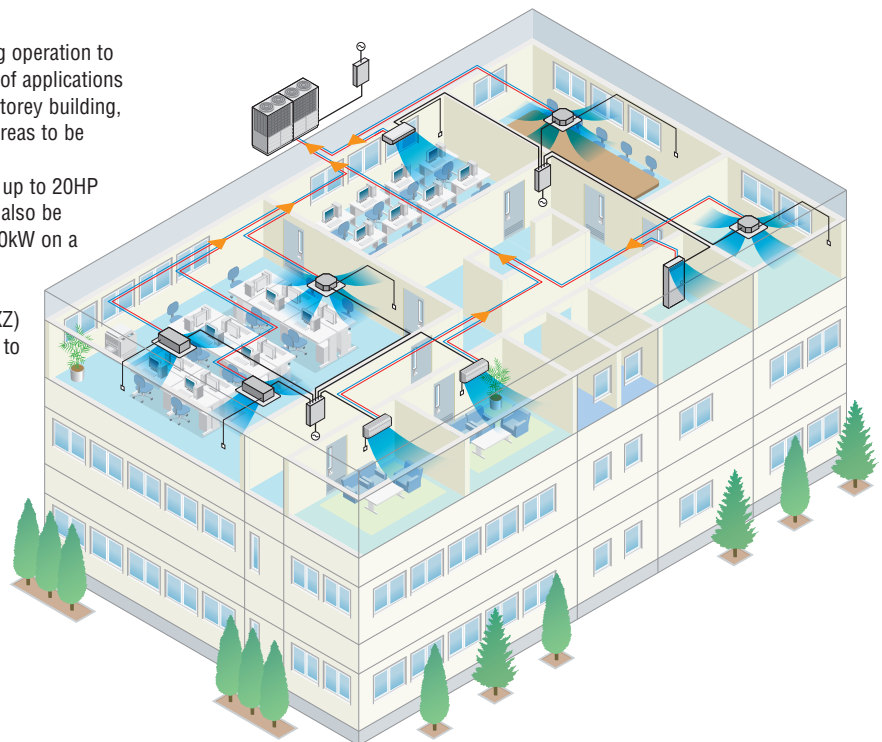

Capacity Range

Capacity	4HP	5HP	6HP	8HP	10HP	12HP	14HP	16HP	17HP	18HP	20HP
Model Code : kW	11.2	14	15.5	22.4	28	33.5	40.0	45.0	47.5	50.0	56.0
BTU / h	38,200	47,800	52,900	76,400	95,500	114,300	136,500	153,500	162,100	170,600	191,100
Capacity	22HP	24HP	26HP	28HP	30HP	32HP	34HP	36HP	38HP	40HP	
Model Code : kW	61.5	67.0	73.5	80.0	85.0	90.0	95.0	100.0	106.0	112.0	
BTU / h	209,800	228,600	250,800	273,000	290,000	307,100	324,100	341,200	361,700	382,100	
Capacity	42HP	44HP	46HP	48HP	50HP	52HP	54HP	56HP	58HP	60HP	
Model Code : kW	120.0	125.0	130.0	135.0	142.5	145.0	150.0	156.0	162.0	168.0	
BTU / h	409,400	426,500	443,600	460,600	486,200	494,700	511,800	532,200	552,700	573,200	

Product Line Up

<Outdoor units>

Micro model



11.2kW 4HP	14.0kW 5HP	15.5kW 6HP
FDC112KXEN6	FDC140KXEN6	FDC155KXEN6
FDC112KXES6	FDC140KXES6	FDC155KXES6



22.4kW 8HP	28.0kW 10HP	33.5kW 12HP
FDC224KXE6G	FDC280KXE6G	FDC335KXE6G

KXZ Lite



22.4kW 8HP	28.0kW 10HP
FDC224KXZPE1	FDC280KXZPE1

Standard model KXZE1



28.0kW 10HP	33.5kW 12HP	40.0kW 14HP	45.0kW 16HP	47.5kW 17HP	50.0kW 18HP	56.0kW 20HP
FDC280KXZE1	FDC335KXZE1	FDC400KXZE1	FDC450KXZE1	FDC475KXZE1	FDC500KXZE1	FDC560KXZE1

FDC280,335 FDC400~560



61.5kW 22HP	67.0kW 24HP	73.5kW 26HP	80.0kW 28HP	85.0kW 30HP	90.0kW 32HP	95.0kW 34HP	100.0kW 36HP	106.0kW 38HP	112.0kW 40HP
FDC615KXZE1	FDC670KXZE1	FDC735KXZE1	FDC800KXZE1	FDC850KXZE1	FDC900KXZE1	FDC950KXZE1	FDC1000KXZE1	FDC1060KXZE1	FDC1120KXZE1
FDC280KXZE1	FDC335KXZE1	FDC335KXZE1	FDC400KXZE1	FDC400KXZE1	FDC450KXZE1	FDC475KXZE1	FDC500KXZE1	FDC500KXZE1	FDC560KXZE1
FDC335KXZE1	FDC335KXZE1	FDC400KXZE1	FDC400KXZE1	FDC450KXZE1	FDC450KXZE1	FDC475KXZE1	FDC500KXZE1	FDC560KXZE1	FDC560KXZE1

FDC615,670



FDC735 FDC800~1120



120.0kW 42HP	125.0kW 44HP	130.5kW 46HP	135.0kW 48HP	142.5kW 50HP	145.0kW 52HP	150.0kW 54HP	156.0kW 56HP	162.0kW 58HP	168.0kW 60HP
FDC1200KXZE1	FDC1250KXZE1	FDC1300KXZE1	FDC1350KXZE1	FDC1425KXZE1	FDC1450KXZE1	FDC1500KXZE1	FDC1560KXZE1	FDC1620KXZE1	FDC1680KXZE1
FDC400KXZE1	FDC400KXZE1	FDC400KXZE1	FDC450KXZE1	FDC475KXZE1	FDC475KXZE1	FDC500KXZE1	FDC500KXZE1	FDC500KXZE1	FDC560KXZE1
FDC400KXZE1	FDC400KXZE1	FDC450KXZE1	FDC450KXZE1	FDC475KXZE1	FDC475KXZE1	FDC500KXZE1	FDC500KXZE1	FDC560KXZE1	FDC560KXZE1
FDC400KXZE1	FDC450KXZE1	FDC450KXZE1	FDC450KXZE1	FDC475KXZE1	FDC500KXZE1	FDC500KXZE1	FDC560KXZE1	FDC560KXZE1	FDC560KXZE1

FDC1200~1680

Hi-COP model KXZXE1



FDC224 FDC280,335

22.4kW 8HP	28.0kW 10HP	33.5kW 12HP
FDC224KXZXE1	FDC280KXZXE1	FDC335KXZXE1



FDC450



FDC500



FDC560~670

45.0kW 16HP	50.0kW 18HP	56.0kW 20HP	61.5kW 22HP	67.0kW 24HP
FDC450KXZXE1	FDC500KXZXE1	FDC560KXZXE1	FDC615KXZXE1	FDC670KXZXE1
FDC224KXZXE1	FDC224KXZXE1	FDC280KXZXE1	FDC280KXZXE1	FDC335KXZXE1
FDC224KXZXE1	FDC280KXZXE1	FDC280KXZXE1	FDC335KXZXE1	FDC335KXZXE1



FDC735



FDC800























FDC850~1000

73.5kW 26HP	80.0kW 28HP	85.0kW 30HP	90.0kW 32HP	95.0kW 34HP	100.0kW 36HP
FDC735KXZXE1	FDC800KXZXE1	FDC850KXZXE1	FDC900KXZXE1	FDC950KXZXE1	FDC1000KXZXE1
FDC224KXZXE1	FDC224KXZXE1	FDC280KXZXE1	FDC280KXZXE1	FDC280KXZXE1	FDC335KXZXE1
FDC280KXZXE1	FDC280KXZXE1	FDC280KXZXE1	FDC335KXZXE1	FDC335KXZXE1	FDC335KXZXE1

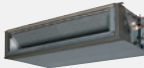

<Indoor units> A range of 17 types of exposed or concealed indoor units available in a wide range of capacities (total 93 indoor models).
The best solution of indoor units for all applications is available from our full lineup.

				1.5kW <0.5HP>	2.2kW <0.8HP>	2.8kW <1HP>	3.6kW <1.25HP>		
Micro model (4~6HP)					←				
Micro model (8~12HP)				←					
KXZ Lite				←					
Standard model KXZE1				←					
Hi-COP model KXZZXE1				←					
Ceiling Cassette	4way	FDT				FDT28KXZE1	FDT36KXZE1		
	4way Compact	FDTC		FDTC15KXZE1	FDTC22KXZE1	FDTC28KXZE1	FDTC36KXZE1		
	2way	FDTW				FDTW28KXE6F			
	1way	FDTS							
	1way Compact	FDTQ			FDTQ22KXE6F	FDTQ28KXE6F	FDTQ36KXE6F		
Duct Connected	High Static Pressure	FDU							
	Low/Middle Static Pressure	FDUM			FDUM22KXE6F	FDUM28KXE6F	FDUM36KXE6F		
	Low Static Pressure(thin)	FDUT		FDUT15KXE6F-E	FDUT22KXE6F-E	FDUT28KXE6F-E	FDUT36KXE6F-E		
	Compact & Flexible	FDUH			FDUH22KXE6F	FDUH28KXE6F	FDUH36KXE6F		
Wall Mounted		FDK		FDK15KXZE1	FDK22KXZE1	FDK28KXZE1	FDK36KXZE1		
Ceiling Suspended		FDE					FDE36KXZE1		
Floor Standing	2way	FDW				FDW28KXE6F			
	With Casing	FDL							
	Without Casing	FDU				FDU28KXE6F			
OA Processing unit		FDU-F			• FDU-F series are not connectable to Micro model (4~6HP), KXZ				
				Air flow m ³ /h	150	250	350	500	
Fresh Air Ventilation and Heat Exchange unit		SAF		SAF150E7	SAF250E7	SAF350E7	SAF500E7		
Fresh Air Assembly		SAF-DX			SAF-DX250E6	SAF-DX350E6	SAF-DX500E6		

	4.5kW <1.6HP>	5.6kW <2HP>	7.1kW <2.5HP>	9.0kW <3.2HP>	11.2kW <4HP>	14.0kW <5HP>	16.0kW <6HP>	22.4kW <8HP>	28.0kW <10HP>
	→								
	→								
	→								
	→								
	FDT45KXZE1	FDT56KXZE1	FDT71KXZE1	FDT90KXZE1	FDT112KXZE1	FDT140KXZE1	FDT160KXZE1		
	FDTC45KXZE1	FDTC56KXZE1							
	FDTW45KXE6F	FDTW56KXE6F	FDTW71KXE6F	FDTW90KXE6F	FDTW112KXE6F	FDTW140KXE6F			
	FDTS45KXE6F		FDTS71KXE6F						
	FDU45KXE6F	FDU56KXE6F	FDU71KXE6F	FDU90KXE6F	FDU112KXE6F	FDU140KXE6F	FDU160KXE6F	FDU224KXZE1	FDU280KXZE1
	FDUM45KXE6F	FDUM56KXE6F	FDUM71KXE6F	FDUM90KXE6F	FDUM112KXE6F	FDUM140KXE6F	FDUM160KXE6F		
	FDUT45KXE6F-E	FDUT56KXE6F-E	FDUT71KXE6F-E						
	FDK45KXZE1	FDK56KXZE1	FDK71KXZE1	FDK90KXZE1					
	FDE45KXZE1	FDE56KXZE1	FDE71KXZE1		FDE112KXZE1	FDE140KXZE1			
	FDFW45KXE6F	FDFW56KXE6F							
			FDL71KXE6F						
	FDU45KXE6F	FDU56KXE6F	FDU71KXE6F						
Lite.				FDU650FKXZE1		FDU1100FKXZE1		FDU1800FKXZE1	FDU2400FKXZE1
		800	1000						
		SAF800E7	SAF1000E7						
		SAF-DX800E6	SAF-DX1000E6						



1. High Efficiency & Comfort

Improved Efficiency

The below graphs highlight the improved efficiencies between the previous models compared to the KXZ standard and Hi-COP models.

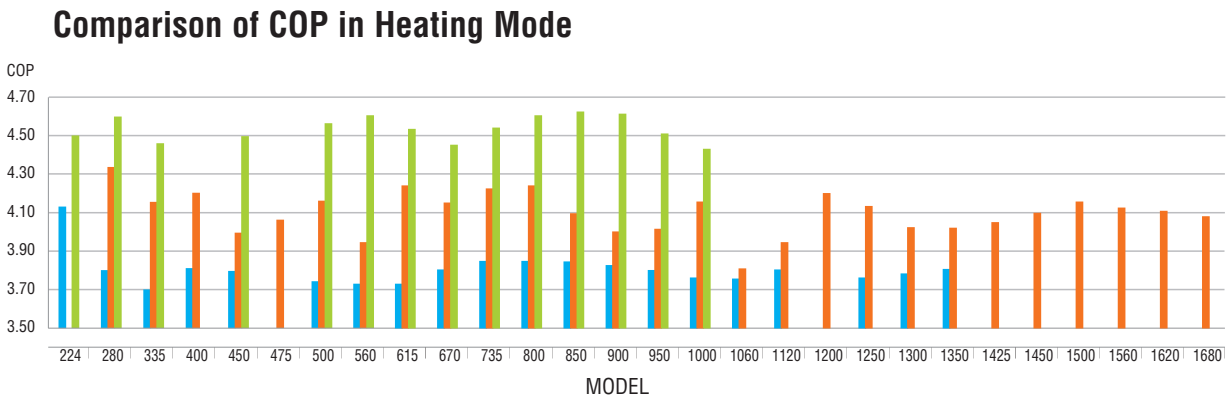
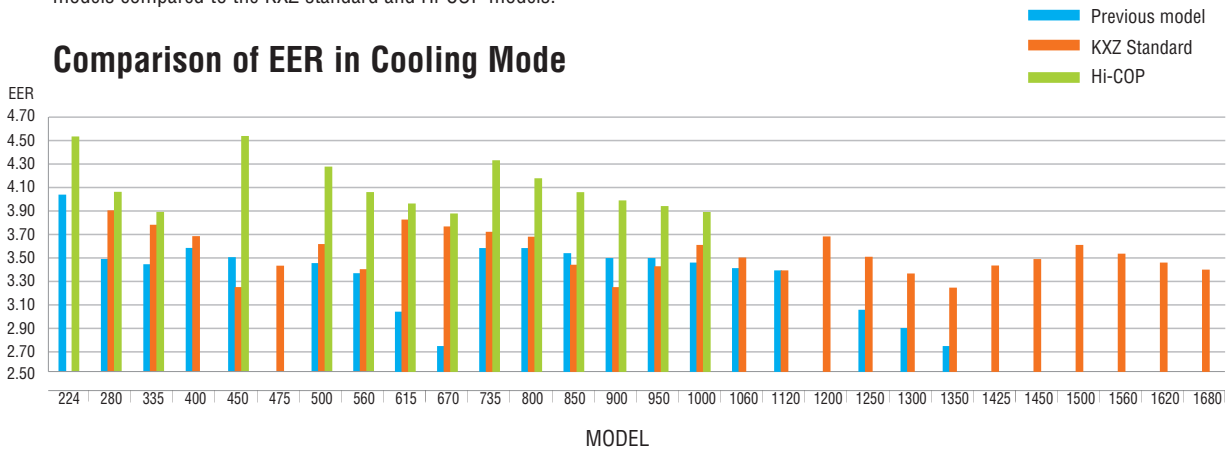

High efficiency and compact design are achieved by applying advanced components

10~60HP

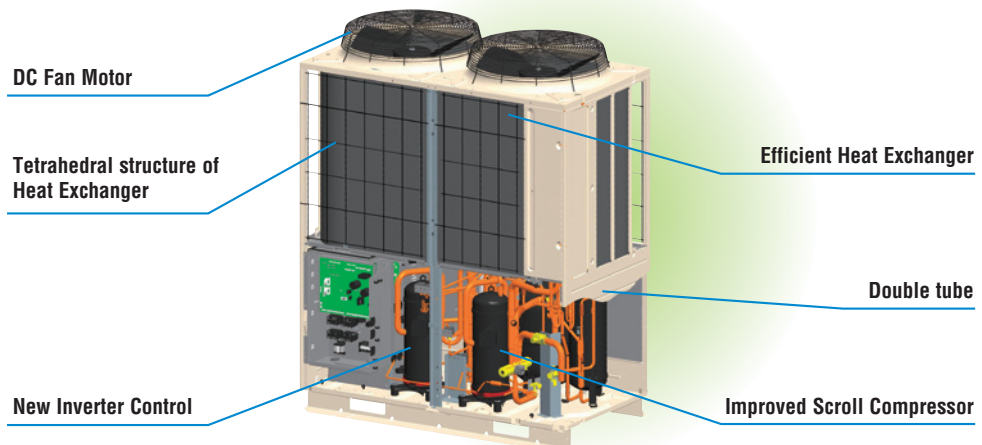

Variable Temperature and Capacity Control

VTCC

- The VTCC is a newly developed energy saving function designed by Mitsubishi Heavy Industries Thermal Systems.
- A new feature to all our KXZ ranges which provides up to 34%* energy savings in both cooling and heating mode.
- VTCC is a function specifically designed to maximise energy savings in partial load conditions throughout all seasons.



*34% energy savings are based on comparison with a KXZ standard model with VTCC vs. a KXZ standard model both under partial load condition.

Normal operation (in the cooling mode)

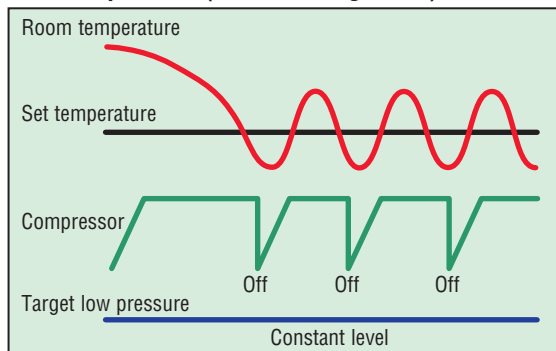

VTCC adjusts the target pressure of the refrigerant cycle in the outdoor unit automatically according to the demand of the indoor units in partial load conditions. These smooth adjustments ensure an optimal capacity usage of the indoor units as well as maximised energy savings. Ultimately this also increases comfort for the user.

Energy saving operation (in the cooling mode)

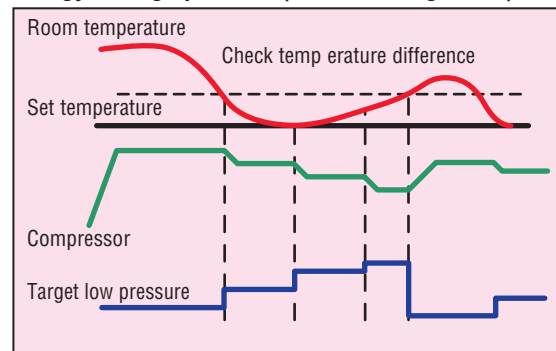

For example, in partial load conditions where you have low cooling and heating requirements, VTCC reduces the compressor frequency and controls the actuators in the outdoor unit. Overall with the VTCC functionality you will always have an additional energy saving of up to 34% (depending on configuration and usage of system) in low cooling and heating load requirements.

Multiport compressor that achieves high efficiency

The new multiport discharge area in the compressor has optimized pressure control with better balancing. The performance improvement at medium Hz has resulted in higher annual efficiencies.

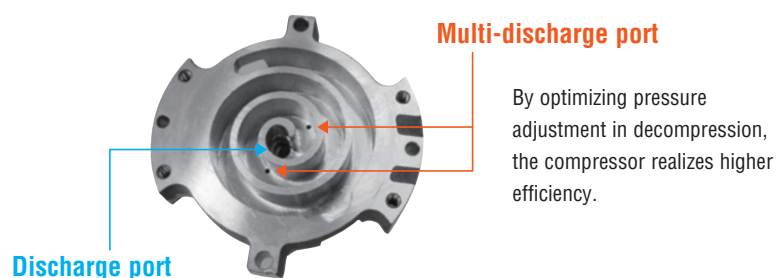



Concentrated winding motor achieves "High Output" and "Total Efficiency Improvement"

The newly designed high performance CPU enables high precision optimization for compressor speed, which leads to concentrated winding motor use. Our product achieves high output and better energy saving effects and in particular improves seasonal efficiency rating.

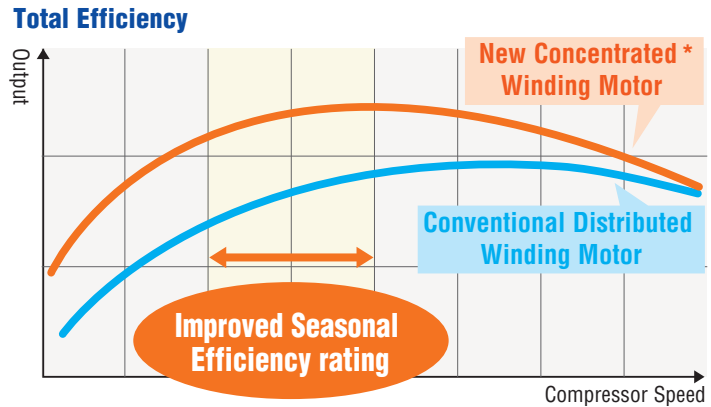

* Applied for KXZE1:10/12/17/18/20HP, KXZXE1:8HP & KXZ Lite:8/10HP

Improved Heat-exchanger

With piping layout rearranged from header to heat exchanger, refrigerant distribution flow has improved and maximum energy efficiency has been achieved. Heat exchanger has improved refrigerant distribution and increased effectiveness. Furthermore due to expansion of effective heat transfer area in heat exchanger, energy efficiency has increased.

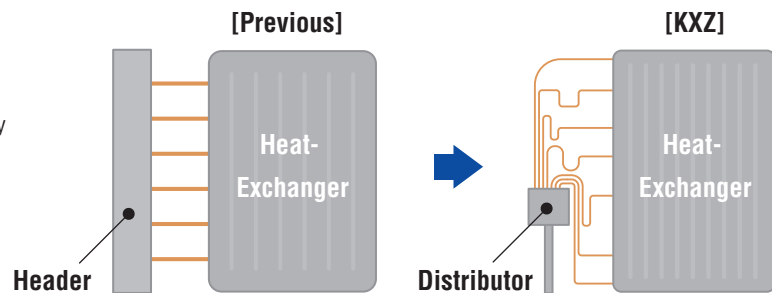

Strengthened resistance against frost

Resistance against frost has been strengthened by achieving improved heat-exchanger.

Vector control

New applied Vector control has a high efficiency and many new advanced features.

- Smooth operation from low speed to high speed
- Smooth Sine Voltage Wave form are attained
- Energy efficiency is further improved in low speed range

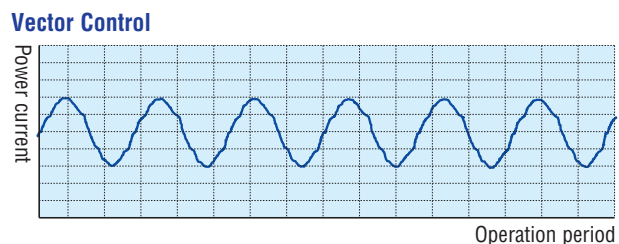

Long-chorded 3 propeller fan with serration

Fan blade design adapted from Mitsubishi Heavy Industries aerospace division - with serrated edges that deliver increased air volume with less power input.

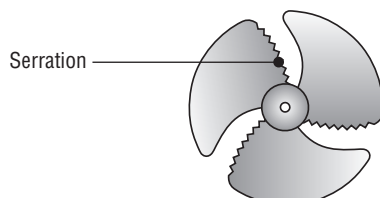

DC Fan Motor

Adoption of DC fan motor has enabled to realize an excellent efficiency of approximate 60% higher than previous models.

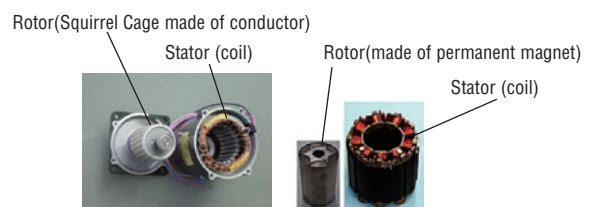

Oil level control capability

Our proprietary technology of adjusts the oil level when combining two or three outdoor units achieving level operation rate, keeping performance of the units and ensuring long life of the system.

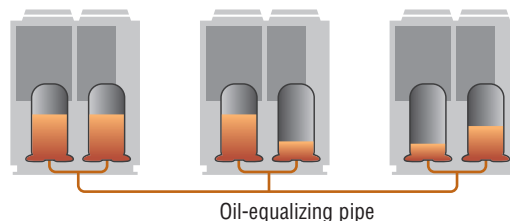

Capacity control (KXZ)

Capacity control can be set by peak cut function with RC-EX3A for better energy saving. Five-step capacity control is available. (100-80-60-40-0%)

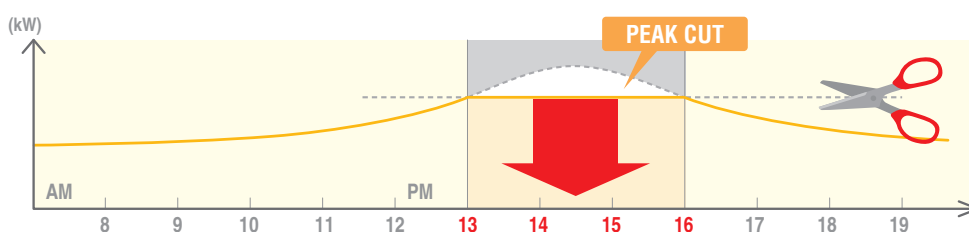

4~6HP (Micro)

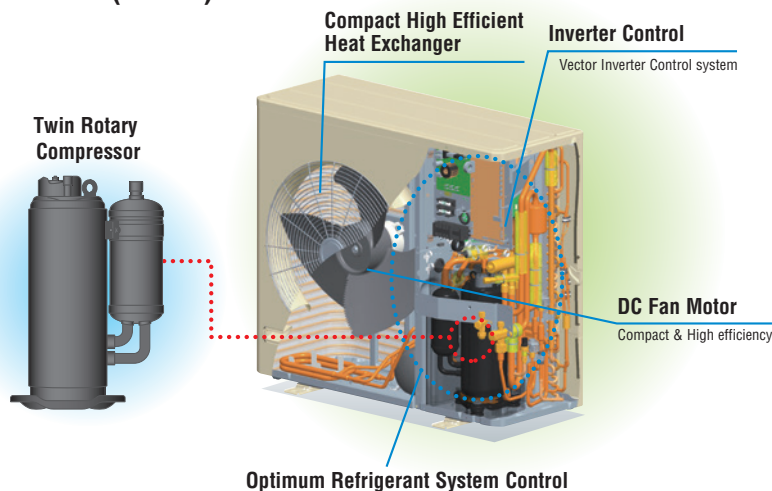

Compact high efficiency Heat Exchanger

- Optimizing relationship of the air flow velocity & fin pattern
- Improvement of air distribution Maximizing efficiency of heat exchanger

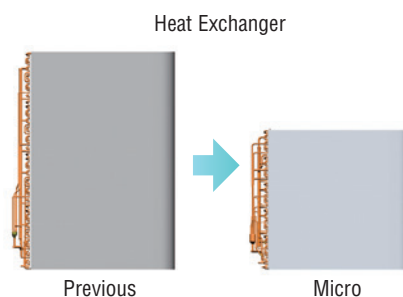

8~12HP (Micro)

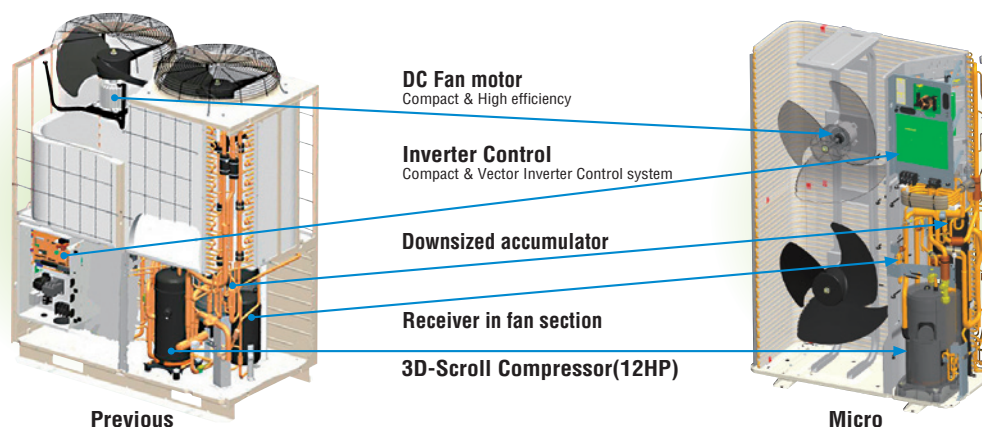



2. Design Flexibility

Indoor unit capacity connection

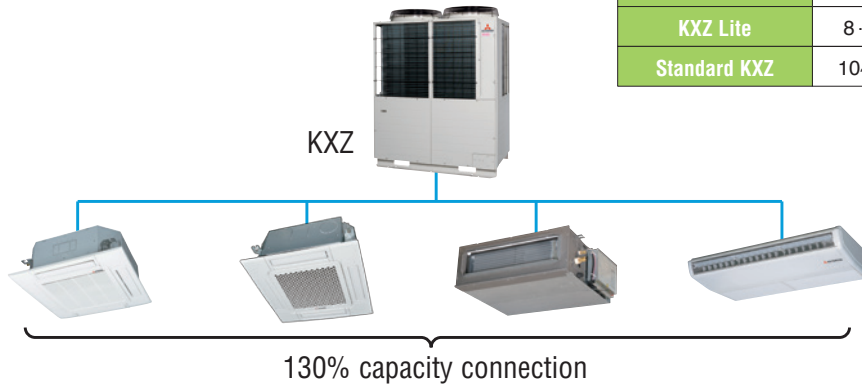

	HP	Capacity connection
Micro model	4~12	150%
KXZ Lite	8 · 10	120%
Standard KXZ	10~60	130%

Connectable indoor units

Micro model	HP	4	5	6	8	10	12	KXZ Lite	HP	8	10
	Numbers	6	8	8	22	24	24		Numbers	8	8

Standard KXZ	HP	10	12	14	16	17	18	20	22	24	26	28	30	32	34
	Numbers	24	29	34	39	41	43	48	53	58	63	69	73	78	80
	HP	36	38	40	42	44	46	48	50	52	54	56	58	60	
	Numbers	80	80	80	80	80	80	80	80	80	80	80	80	80	80

Wide Range of Operation (KXZ, KXZ Lite)

KXZ series permits an extensible system design considering a heating range operation down to -20°C and a cooling range operation up to 46°C (previous model : 43°C)
 Furthermore KXZ Lite extends a cooling range operation up to 50°C.

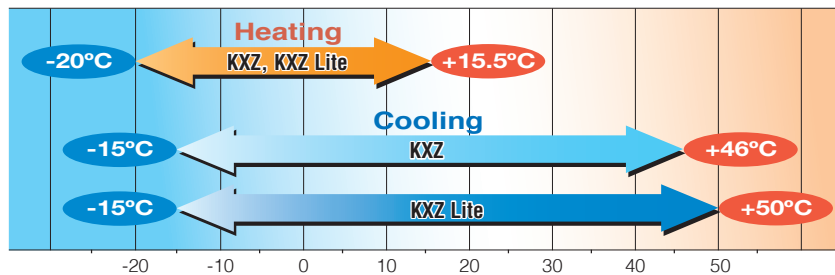

Control Systems

All series offer wide choice of control system and provide the best solution.

[Control system units with SUPERLINK- II]

Classification	Type	Model	Connectable Indoor units (Maximum)	Electric power calculation	
Individual controller	Wired	RC-E5	16	—	
		RC-EX3A	16	—	
	Wireless	RCN-T-5AW-E2 etc.	16	—	
Center Console	Push buttons	SC-SL1N-E	16	—	
		SC-SL2NA-E	64	—	
	Touch screen	SC-SL4-AE	128	—	
		SC-SL4-BE	128	●	
	BMS interface units	Web gateway & BACnet	SC-WBGW256	256(128x2)	●
		Lonworks	SC-LGWNB	96(48x2)	—

Long Pipe Length 10~60HP(KXZ)

Piping length has extended max height difference between indoor units up to 18m and enables us to put indoor units on extra three floors. The furthest indoor unit: 160m or total length: 1000m contributes to system design flexibility.

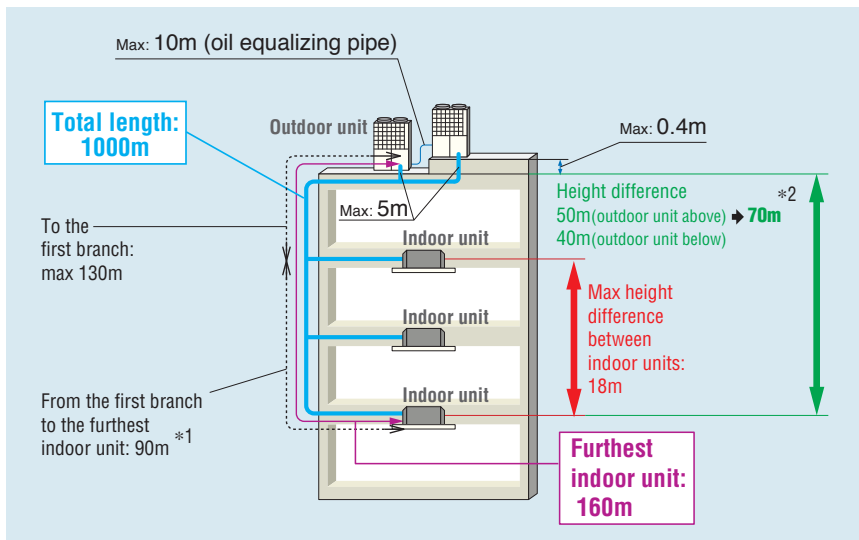

*1 The difference between the longest and the shortest indoor unit piping from the first branch must be within 40m. (MAX85m)

*2 In case of height difference up to 70m, please contact your dealer. Height difference up to 100m is possible with High Head series. Please refer to page 56.

Easy Transportation & Installation

Due to realization of significant reduction in size and foot print which is one of the smallest in the industry, transportation in an elevator made for six persons (Width:1400mm, Depth:850, Open area:800mm) is possible, eliminating cost of a crane and reducing labor.

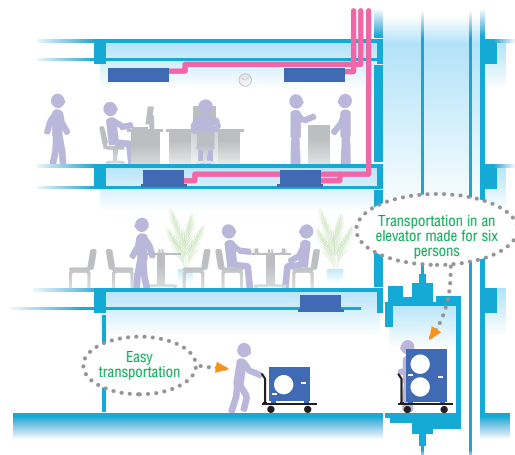
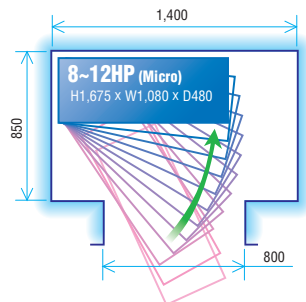

KXZ is portable and the uniform reduced footprint allows neat, continuous installation.

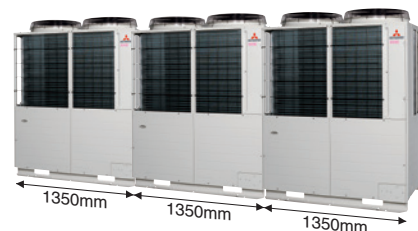
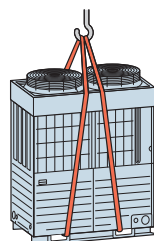

Blue Fin

Due to application of blue coated fins for the heat exchanger of new outdoor unit, corrosion resistance has been improved compared to previous models.

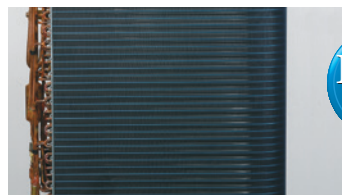

Automatic Select functions for capacity control (KXZ Lite)

The following 3 items are available for capacity control function. User can select one item individually or select 2or3 items at the same time. In case of selecting 2or3 items, the unit will operate with the most effective function automatically.

- **Compressor speed control**

User can set compressor speed at 100%-80%-60%-40% before starting operation with PWB in the outdoor unit or with a demand controller (procured locally).

- **Capacity control timer**

User can set capacity control with RC-EX3A up to 4 times per day maximum. The timer setting can be changed using 5 minute intervals.

※Please refer to page 13.

- **Silent mode**

Considering noise regulations or surrounding circumstances, you can now select 4 levels of silent mode. Setting the combination of silent mode is available by using timer function of RC-EX3A.

Priority operation mode rule

User can select the following priority operation mode. (for whole system)

1. First unit's operation mode (by default setting)
2. Last unit's operation mode
3. Majority operation mode (see below)
4. Master operation mode (see below)

<Majority operation mode>

The system is operated according to the mode selected by the majority of units in operation (whichever greater capacity between the sums of cooling mode and heating mode). The operation mode in minority is set to fan mode automatically.

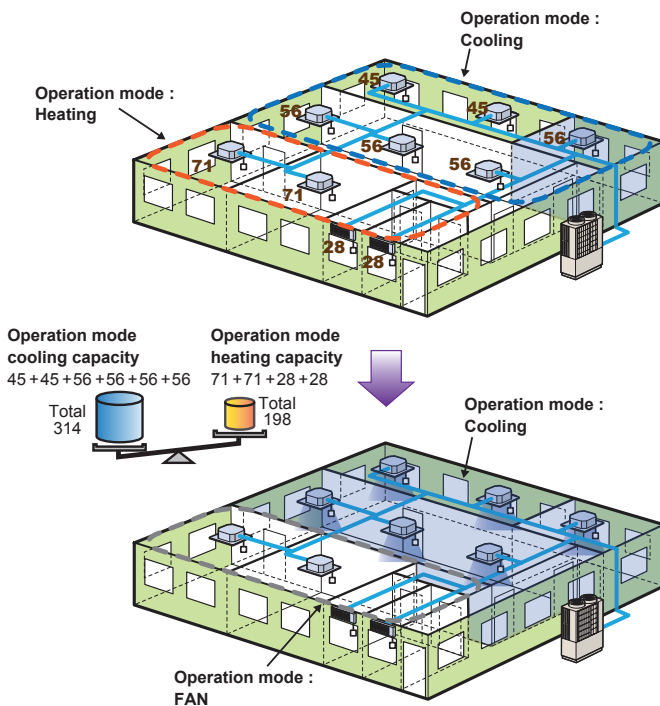

<Master operation mode>

The system is operated according to master operation mode. When master operation mode is set at cooling mode, units selected as heating mode is set to fan mode automatically.

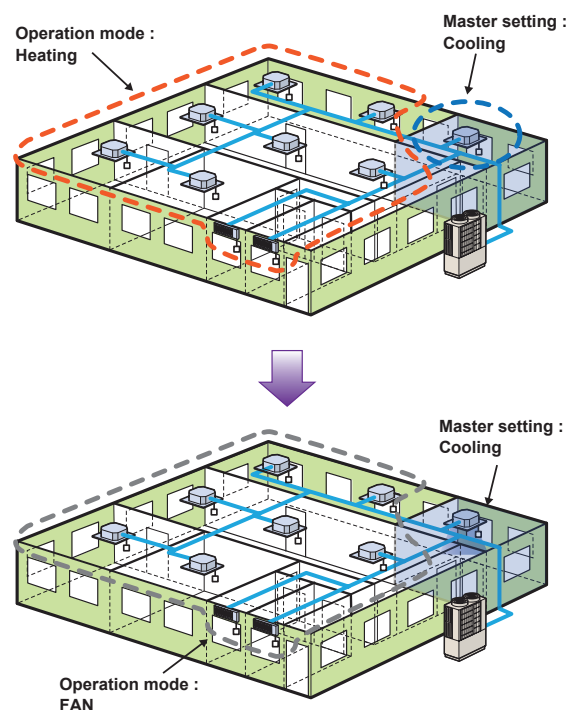

Fixed Cooling mode/fixed heating mode (summer/winter switch)

It is possible to fix the operational mode of the system (either cooling or heating) using a switch (SW3-7) on the outdoor unit PC board - this enables the building user to decide the operation of the system (e.g. cooling only in summer/heating only in winter), to avoid unnecessary energy wastage. It is also possible to wire the control switch to a remote location (inside the building) to a control room, or even linked to an ambient thermostat.



Back-up Operation

In the event that one unit has a failure, the system will keep operating with the other good units.

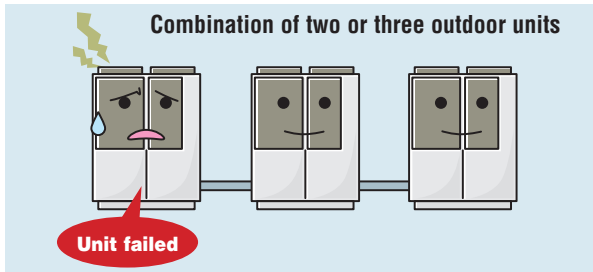

In the event that one compressor has a failure, the unit will keep operating with the other good compressor.

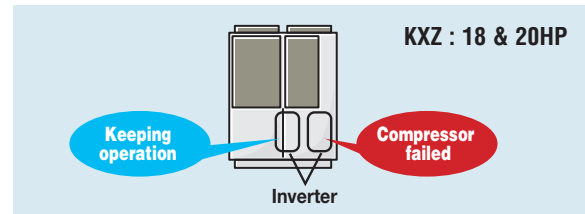

This operation is an emergency measure for a limited time and a necessary repair should be done as soon as possible.

Improved features (KXZ Lite)

Improved freedom of piping layout

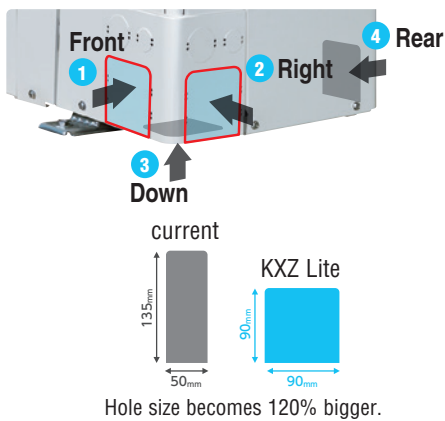

Wire insertion holes for fall prevention

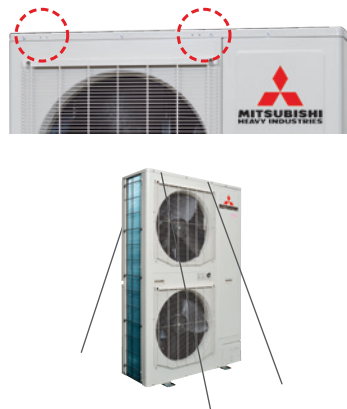

External static pressure

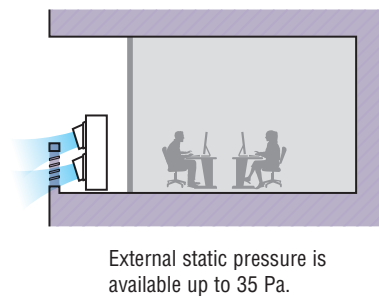

Four handles

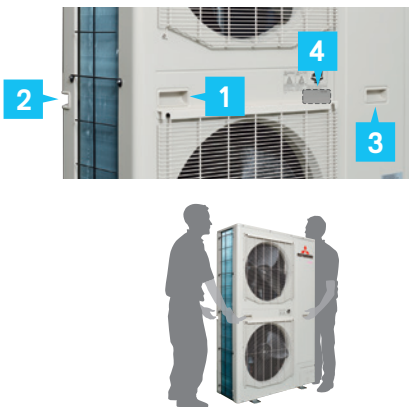

Located at the same level for easy transport and transfer.

A transparent rain cover



Attached as a standard for easy maintenance.

Fixing screws to service panel

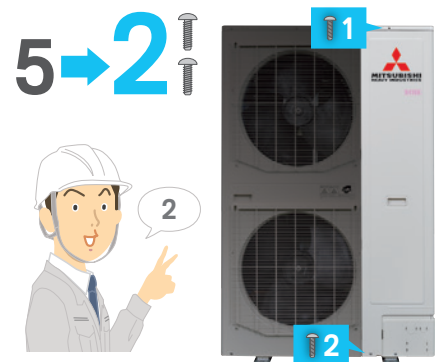

Decreasing number of screws from 5 to 2, installation & service speed is improved.



Easy Selection Tool e-solution

e-solution is a design software tool which includes specification details of the latest KXZ VRF systems. By using e-solution this simplifies the process and enables engineers to select the suitable indoor units, outdoor units, pipework, controls & calculate the additional refrigerant required.

Engineers must register and download the e-solution software and ensure to download the latest updates when available and this can be done by simply visiting

<https://mhiae.com/e-solution/>

Furthermore it was also developed to cater for the design of two and three pipe systems and specifies appropriate models and sizes. It also generates wiring diagrams and engineering drawings which can be exported to AutoCAD or saved in PDF format.

This flexibility enables engineers to print select design information and technical data for presentations to clients. Engineers can also incorporate design information into their own formats and documents for personalised proposals.

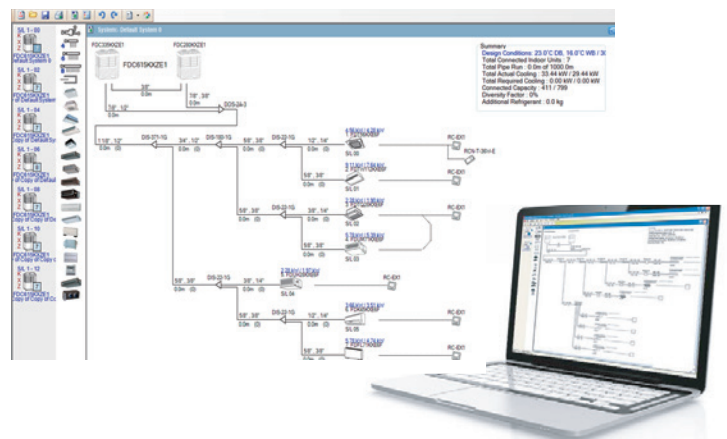



New Generation FDTC

European design & Flat panel



Ceiling cassette
Compact

FDTC

- More comfort and Higher energy savings
- New European Design
- Lower noise



A' Design Award and Competition is the World's largest, most prestigious and influential design accolade, the highest achievement in design. A' Design Award Winner Logo, symbolizes exceptional design excellence in your products, projects and services.



Thin Panel
FDTC thin panel fit within 10mm from the ceiling.

Unique Grille Design
Honeycomb grille

Draft Prevention Panel (Option)
Please refer to next page

Motion Sensor (Option)
Please refer to page 22,25

Big Louver
Improved distribution

It is available to set draft prevention panel and motion sensor as well as FDT.

Compact Design

□700mm → □620mm

It's only 14kg

Height of thin panel and main body is only 248 mm allowing a very easy installation.



Quieter operation

Adopting new turbo fan and improving new heat exchanger enable to reduce noise. (Sound pressure level in the Lo mode.)

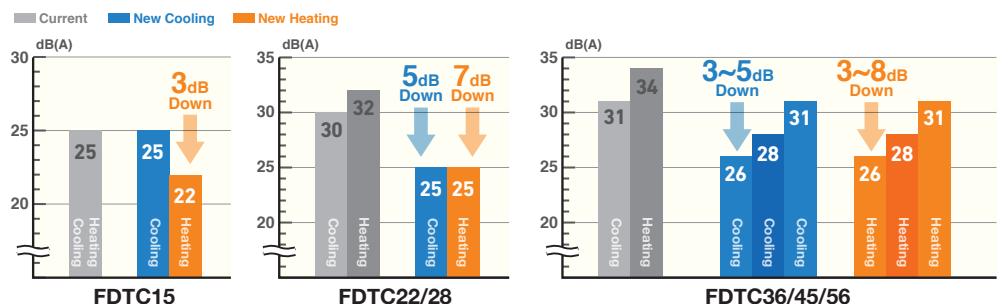

Draft Prevention Panel (Option)

Keep maximum comfort with minimal draft : New FDT & FDTC control flaps with more flexibility.

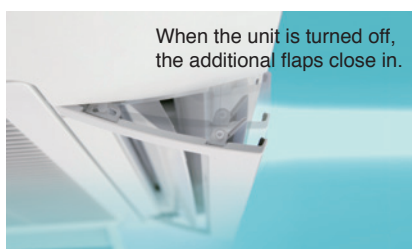

- Brand new function in the market
- Flexible flap control for draft prevention

Each of the 4 flaps can be controlled individually at each operation mode. They change air flow direction and prevent draft feeling. This new function also achieve more flexible control for air flow direction. User can position Draft Prevention Panel panels by using the remote controller only (RC-EX3A,RCN-T-5AW-E2).

• It can also prevent user from being directly blown by hot drafts in heating mode.



Draft Prevention Panel off

Draft Prevention Panel working ※

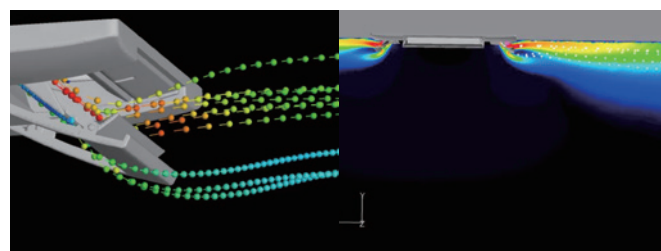
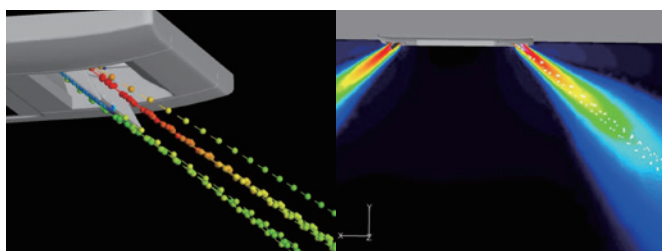

Draft Prevention Panel provides a comfortable airflow without any draft feeling. Whether cooling or heating a room, the remote control can be used to instantly suppress any warm or cool drafts. This accurately assists how air flow is directed out of the indoor unit.

※ Image is for illustration purposes

Ceiling cassette
FDT



The Good Design Award is Japan's only comprehensive design evaluation and recommendation initiative, originating with the "Good Design Products Selection System" founded in 1957. It is now a global design award with participation from numerous Japanese and international companies and organizations. The "G Mark", the symbol of the Good Design Award, is known widely as a symbol of excellent design. (FDT)



Motion sensor (Option)

Energy saving operation by detecting human movement



Applied models



FDT



FDTC



FDTW



FDTS



FDU



FDUM



FDUT(71only)

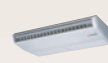

FDE



FDK



FDU-F

3 Step Control



1 Power Control

New motion sensor (option) detects human activity. Energy saving control is achieved by shift set temperature according to detected amount of activity.

2 Stand by

Unit will go on stand-by mode when no activity is detected. When the motion sensor detects activity again, the unit will automatically re-start operation.

3 Auto Off

Unit will go off automatically when no activity is detected for 12 hours.

Low human activity (in cooling)



High human activity (in cooling)



Absence for 1 hour



More 12 hours absence



in cooling

Set temperature

26°C

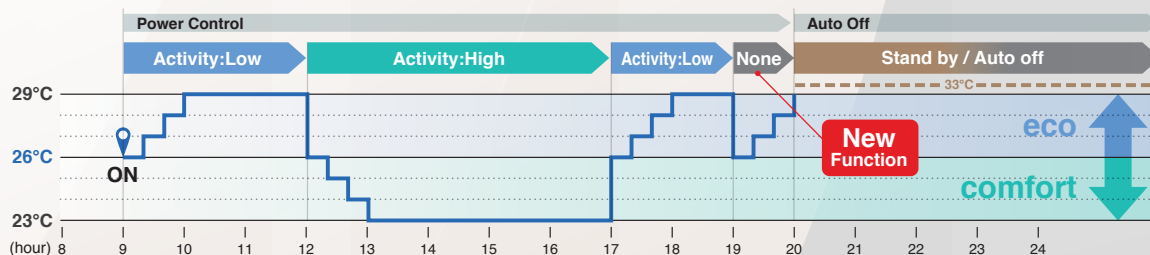

in heating

Set temperature

22°C

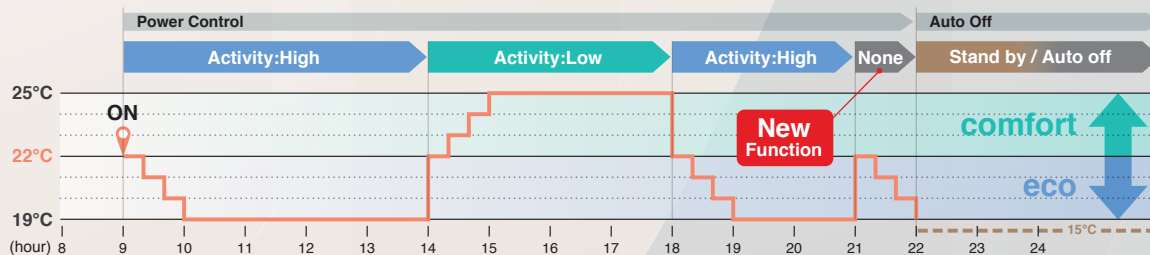

Operation mode and Control of Motion sensor

		Operation mode					
		Auto	Cool	Heat	Dry	Fan	
Power Control ※1	Human activity 	Low	Cooling +3°C Heating +3°C	+3°C	+3°C	—	—
		High	Cooling -3°C Heating -3°C	-3°C	-3°C	—	—
		None	Cooling +3°C Heating -3°C	+3°C	-3°C	—	—
Auto Off ※2		●	●	●	●	●	

※1 Set temperature is revised maximum $\pm 3^{\circ}\text{C}$ at Cooling/Heating mode by detecting heat volume movement.

※2 Absence for 1 hour \Rightarrow Operation stops ("Stand-by") More 12 hours absence \Rightarrow Operation stops completely



Serviceability & workability

Easy and quick installation and maintenance Indoor unit is easily positioned and installed



Builder Maintenance

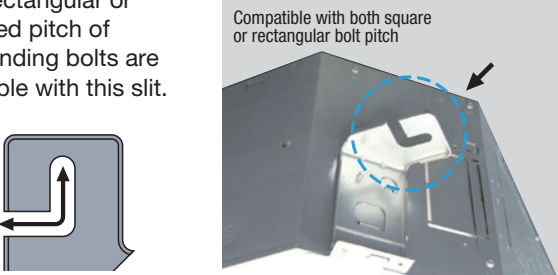
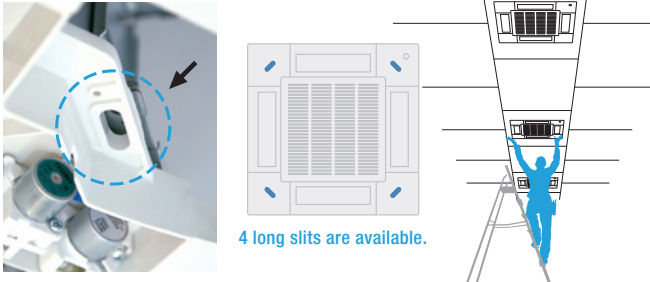

Quick positioning !

<p>1 Adjustable easier positioning of unit by new slits FDT</p>	<p>2 New slit in panel allows easier installation on site. FDT FDC</p>
<p>New shape of slit is suitable to install the unit with more flexibility, according to many kinds of suspending bolt pitch on site. Any rectangular or squared pitch of suspending bolts are available with this slit.</p> 	<p>Flexible positioning is available, which helps adjusting the direction of panel according to lines or pattern on the ceiling.</p> 

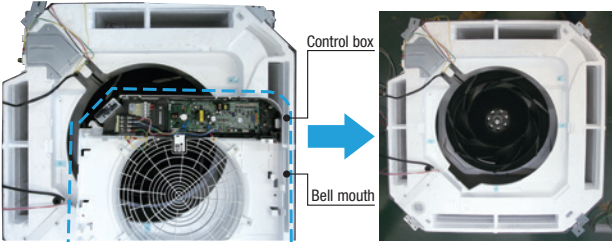
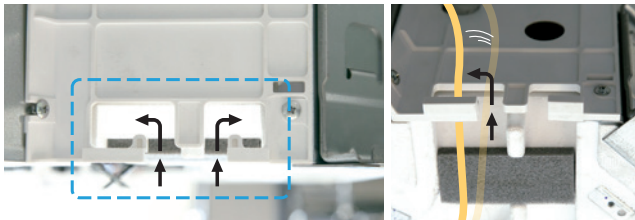
Quick installation and maintenance

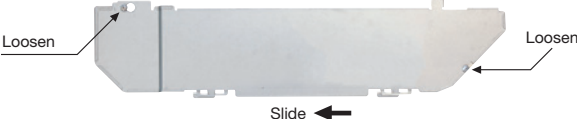
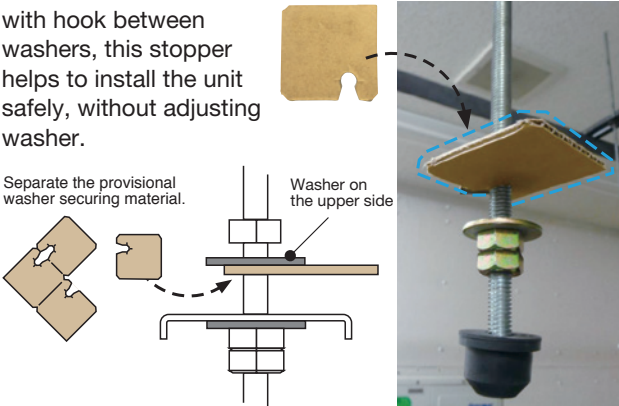
<p>1 Easy access to component part for easy maintenance. FDT</p>	<p>2 New shape of path of wiring FDT</p>
<p>1 The control box and bell mouth can be removed together. 2 Easy access to impeller and fan motor.</p> 	<p>New shape of path gives easy wiring work for installation.</p> 
<p>3 No need to remove screws to open the controller cover. FDT</p>	<p>4 More safe installation by stopper of washer FDT FDC</p>
<p>It is possible to loose and slide open the cover without removing of the screws. This prevents the cover from falling and damaging to stuffs on site.</p>  	<p>When unit is installed with hook between washers, this stopper helps to install the unit safely, without adjusting washer.</p> 

Builder Maintenance



For smooth and easy working

Easy installation and maintenance

1 Easy and flexible hook to remove the filter FDT
FDTC

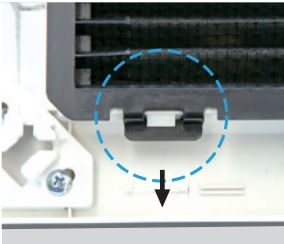

Hook of soft material helps to remove the filter without dust spreading.



Press the filter tab to the outside and remove the filter.

2 Securely fix the corner lid by strap FDT

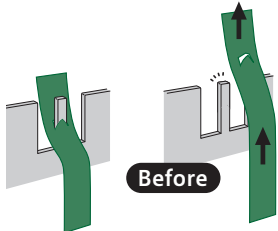
The direction of the strap hook part has been changed from longitudinal to lateral. Furthermore, a barb has been added to the hook pin to prevent the strap from coming off.





Easy to hook but not easy to loose

3 Drain-up-lift increases up to 850 mm FDT
FDTC

The drain can be lifted up to 850 mm from the ceiling surface.

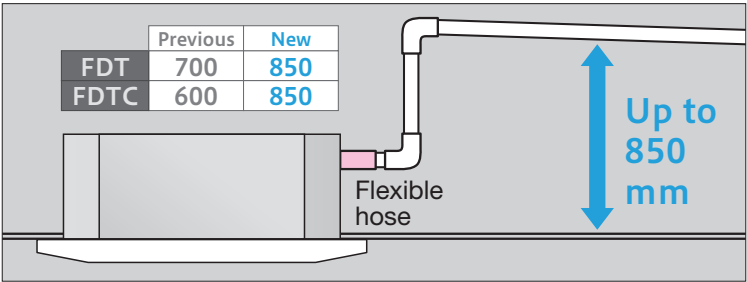
	Previous	New
FDT	700	850
FDTC	600	850



Up to 850 mm

4 New port to check drain water flow FDT

A water supply port has been provided in the piping lid for easier testing of the drain water flow. (The port is usually sealed with a rubber cap.)

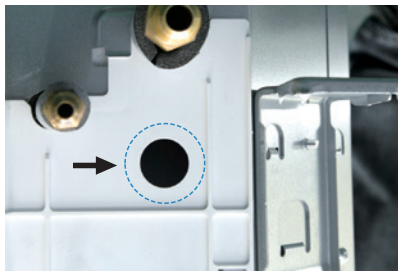

5 Re-use of packages during construction work FDT
FDTC

Package material (carton) help to protect the unit from unexpected welding spatter or coming dust to the new unit.

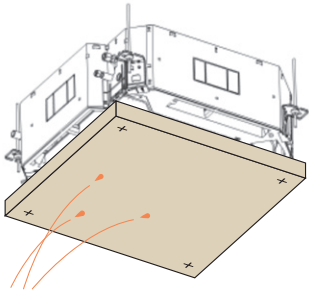

6 More flexible outlet for ducting FDT
FDTC

Both $\phi 125$ and $\phi 200$ (oval shaped) are available.

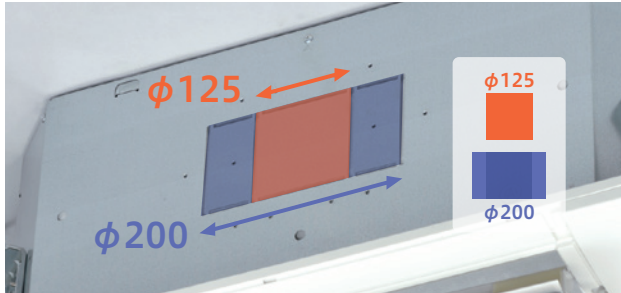



Simple use with advanced settings REMOTE CONTROL

Intuitive touch controller with Liquid Crystal Display



Add new function

RC-EX3A

Functions

Function Switch

The function switch allows you to select and set two functions of your choice among the six available functions shown.

These functions can be used by simply pressing the button after they are set, allowing you to use your preferable functions immediately.

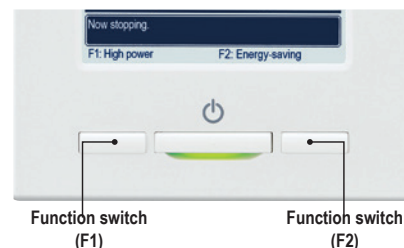

1 High Power Mode

High Power Mode achieve excessive cooling / heating capacity for 15 minutes to quickly adjust the room temperature to a comfortable level.



2 Energy Saving Mode

Temperature is set to optimized to save energy without losing comfort.



3 Quiet Mode

Outdoor unit starts to operate quietly by activating this mode. The time of this mode can be set in conjunction with Indoor Silent Timer.



4 Home Leave Mode

Home leave mode maintains the room temperature at a moderate level.



5 Favourite Mode

Operation mode, set temperature, fan speed and air flow direction are automatically adjusted to the programmed favourite setting.



6 Filter Sign

Announces the due time for cleaning the air filter.



7 Anti draft ON/OFF

Auti draft can be turned ON/OFF with a single tap of the button.

Favourite Mode

Operation mode, set temperature, fan speed and air flow direction are memorized and allocated to two buttons that can be operated by one touch.

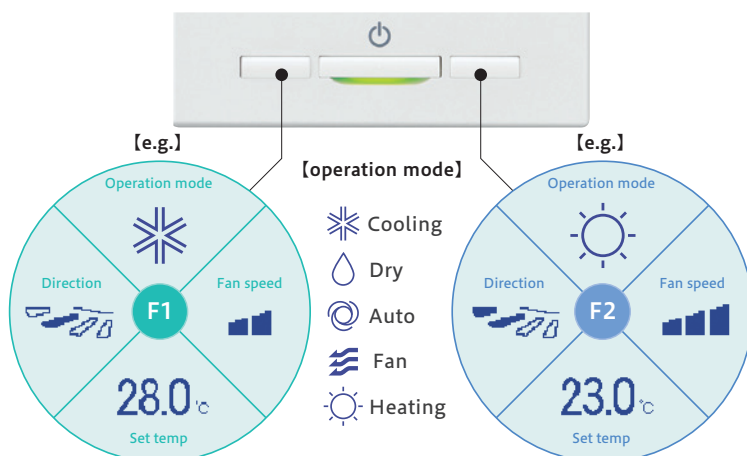

Adjusting Brightness of the Operation lamp

The brightness of the operation lamp behind Run/Stop switch can be adjusted by 10 stages.



Draft prevention setting (only FDT/FDTC series)

User can enable/disable the motion of panel with anti draft for each blow outlet for each operation mode. This function can be set while operating. **NEW**

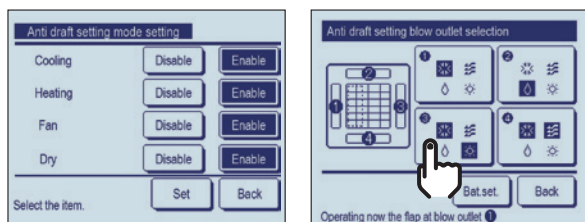

Easy adjustment of the Air Flow

User can visually confirm and set the direction of louvres using the visual display on the remote controller.

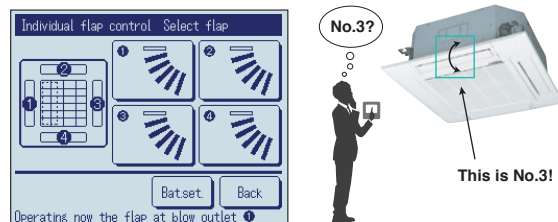

Motion sensor control

Presence of humans and activity are detected by a motion sensor to perform various controls.

- 1 Select Enable / Disable
Motion sensor control



Enable / Disable

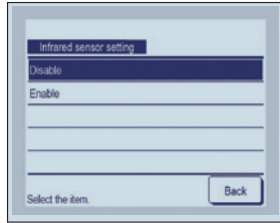

Select [Enable] / [Disable] for the motion sensor of the indoor unit connected to the R/C.

- 2 Select Enable / Disable per control

- Power control
- Auto-off

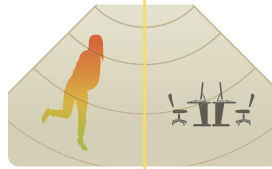

Enable / Disable

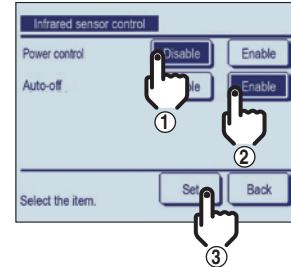

Backup Control

Control restricted to two indoor units (two groups)



Fault backup control



Keep back up all the time!

If one of the two indoor units malfunctions and stops its operation, the other starts backup operation so that users' comfort will not be compromised.

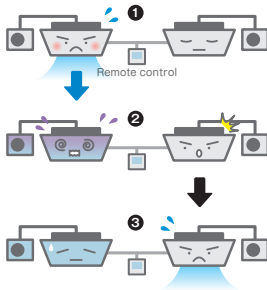

Capacity backup control



Maintains users' comfort!

When the control system detects either of two units is operating with overload, the other unit cover the capacity.

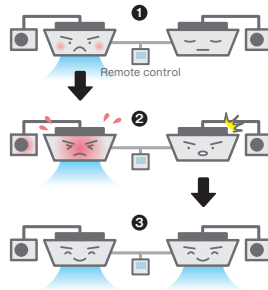

Rotational operation control **NEW**



Energy saving and longer life!

By operating two indoor units alternately, their chronological changes are equalized. (The alternate operation cycle can be specified in a range from 1 to 999 hours in increments of 1 hours.)

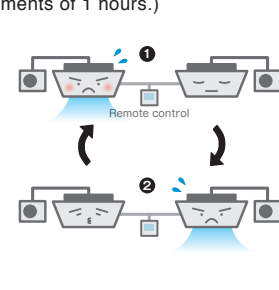

Additional functions of External Input / Output

The external input/output of indoor unit by remote controller can set input/output based on user's demand.



Remote surveillance system



Card key on-off

External Input

CNT (1-6) CNTA (1-2)	
Input	On/Off Permission/Prohibition Cooling/Heating Emergency Stop
Newly added	<div style="border: 1px dashed red; padding: 5px;"> Set temp. shift Forced thermo-off IU operation stop Silent mode </div>

External Output

CNT (New)	
2	Output - Operation - Heating - Compressor ON (thermo-ON)
3	Output - Inspection
4	Output - Cooling (defrosting) - Fan operation - Fan operation with Phi or Hi - Fan operation with Me or Lo - Defrosting (oil return in heating operation)
5	Output - Ventilation - Heater ON - Free cooling - IU overload alarm

Newly added

Silent mode control

The Outdoor unit is controlled prioritising quiet operation. Silent mode control must be set to the F1 or F2 switch. User can start/stop the silent mode control with a single tap of a button.

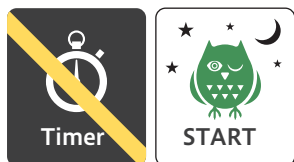

Language Switching NEW

User can select from the following languages and also switch them on the top display.



Indoor unit capacity display

Capacities of Indoor units connected to the RC-EX3A are displayed.

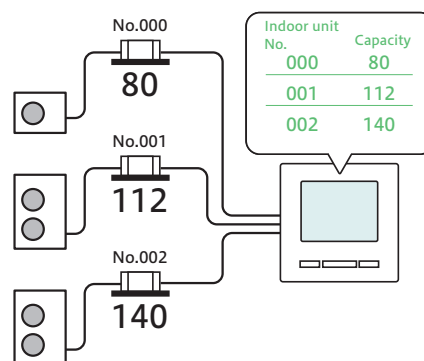
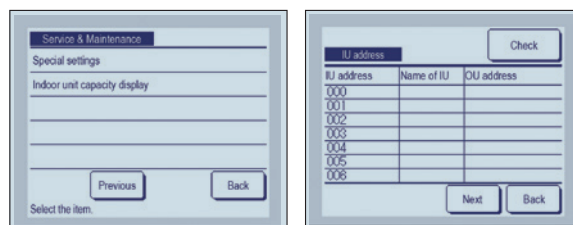

Contact company & Error display

If any error occurs on the air conditioner, the "Unit protection stop" is indicated on the message display.

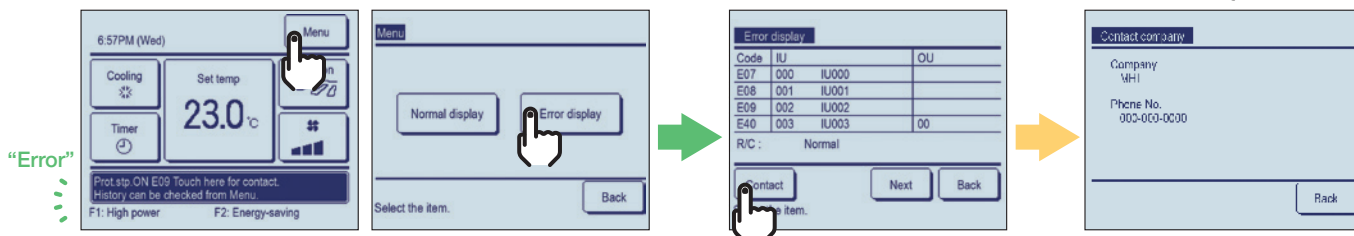

Wireless Kit & Wireless Remote Controller

Line-up

Model	Wireless kit
FDT	RCN-T-5AW-E2
FDTC	RCN-TC-5AW-E2
FDTW	RCN-TW-E2
FDTs	RCN-TS-E2
FDK	RCN-K-E2, RCN-K71-E2
FDE	RCN-E-E3
PDFW	RCN-FW-E2
FDTQ, FDU, FDUM, FDUT, FDUH, FDFL, FDFU, FDU-F	RCN-KIT4-E2

Function added

- 1) High power
- 2) Energy-saving
- 3) ON/OFF Timer by clock
- 4) Child lock
- 5) Silent mode control for Outdoor unit
- 6) Home leave mode

The functions and the operations will be improved.



Display

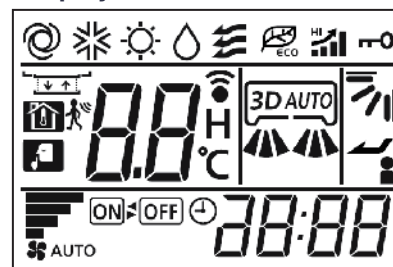



Outdoor units

Micro model Heat pump systems

4, 5, 6HP (11.2kW~15.5kW)

Model No.	Nominal Cooling Capacity
FDC112KXEN6	11.2kW (220V)
FDC140KXEN6	14.0kW (220V)
FDC155KXEN6	15.5kW (220V)
FDC112KXES6	11.2kW (380V)
FDC140KXES6	14.0kW (380V)
FDC155KXES6	15.5kW (380V)

- Connect up to 8 indoor units/up to 150% capacity.
- High efficiency with COP (in cooling) up to 4.0.
- KX6 employs DC inverter compressors ONLY.
- Industry leading total piping length up to 100m and a maximum pipe run of 70m.



Note: FDUT15KXE6F-E, FDC15KXE1 and FDK15KXE1 can not be connected to the above systems.

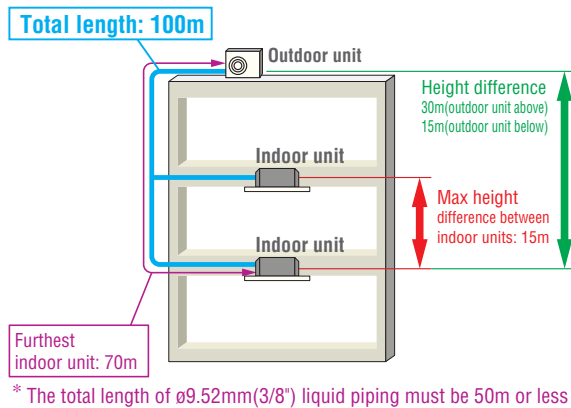

Range of operation

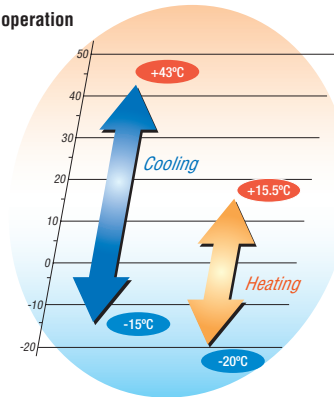

Specifications

Item	Model	FDC112KXEN6	FDC140KXEN6	FDC155KXEN6	FDC112KXES6	FDC140KXES6	FDC155KXES6	
Nominal horse power		4HP	5HP	6HP	4HP	5HP	6HP	
Power source		1 Phase 220-240V, 50Hz			3 Phase 380-415V, 50Hz			
Starting current	A				5			
Max current	A	23			13.5			
Nominal capacity	Cooling	11.2	14.0	15.5	11.2	14.0	15.5	
	Heating	12.5	16.0	16.3	12.5	16.0	16.3	
Electrical characteristics	Power consumption	Cooling	2.80	4.17	4.71	2.80	4.17	4.71
		Heating	2.89	4.31	4.38	2.89	4.31	4.38
Exterior dimensions	HxWxD	mm 845x970x370						
Net weight	kg	85			87			
Sound pressure level	Cooling/Heating	52/54	53/57	53/57	52/54	53/57	53/57	
Refrigerant	Type / GWP	R410A / 2088						
	Charge	kg/TCO ₂ Eq 5.0 / 10.44						
Refrigerant piping size	Liquid line	mm(in) ø9.52(3/8")						
	Gas line	mm(in) ø15.88(5/8")						
Capacity connection	%	80~150						
Number of connectable indoor units		6	8	8	6	8	8	

1. The data are measured under the following conditions(ISO-T1). Cooling: Indoor temp. of 27°CDB, 19°CWB, and outdoor temp. of 35°CDB. Heating: Indoor temp. of 20°CDB, and outdoor temp. of 7°CDB, 6°CWB. Piping length is 7.5m.
 2. Sound pressure level indicates the value in an anechoic chamber. During operation these values are somewhat higher due to ambient conditions.
 3. 'tonne(s) of CO₂ equivalent' means a quantity of greenhouse gases- expressed as the product of the weight of the greenhouse gases in metric tonnes and of their global warming potential.

Refrigerant piping

Outdoor unit (HP)		4	5	6
Gas pipe	Furthest indoor unit =<70m	ø15.88		
Liquid pipe		ø9.52		

Branch pipes

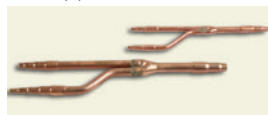

DIS-22-1G
DIS-180-1G

Header pipe



HEAD4-22-1G
HEAD6-180-1G

Dimensions

All measurements in mm.

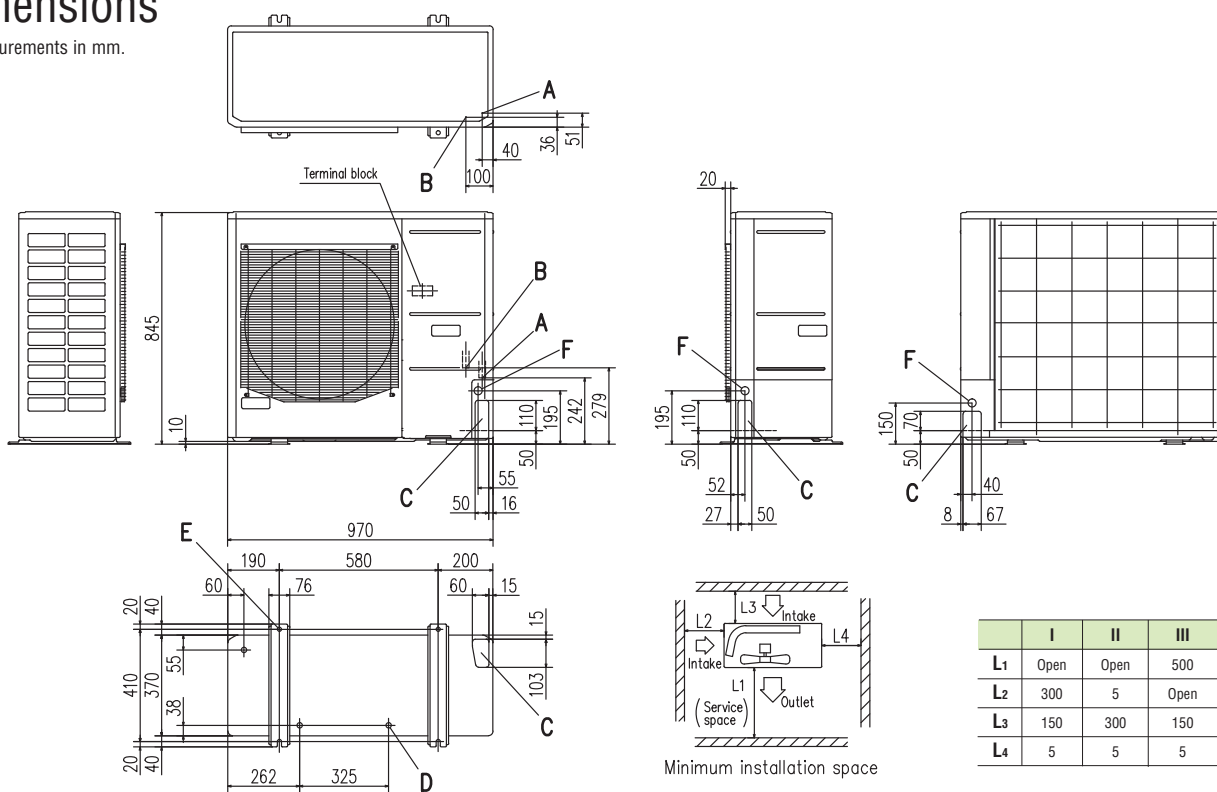

Mark	Content	
A	Service valve connection (gas side)	ø15.88 (5/8") (Flare)
B	Service valve connection (liquid side)	ø9.52 (3/8") (Flare)
C	Pipe/cable draw-out hole	
D	Drain discharge hole	ø20 x 3 places
E	Anchor bolt hole	M10 x 4 places
F	Cable draw-out hole	ø30 x 3 places

Notes:

- (1) It must not be surrounded by walls on the four sides.
- (2) The unit must be fixed with anchor bolts. An anchor bolt must not protrude more than 15mm.
- (3) Where the unit is subject to strong winds, lay it in such a direction that the blower outlet faces perpendicularly to the dominant wind direction.
- (4) Leave 1m or more space above the unit.
- (5) A wall in front of the blower outlet must not exceed the units height.
- (6) The model name label is attached on the lower right corner of the front panel.



Micro model Heat pump systems

8, 10, 12HP (22.4kW~33.5kW)



Model No.	Nominal Cooling Capacity
FDC224KXE6G	22.4kW
FDC280KXE6G	28.0kW
FDC335KXE6G	33.5kW

- Connect up to 24 indoor units/up to 150% capacity.
- High efficiency with COP (in cooling) up to 4.0.
- These units employ DC inverter compressors ONLY.
- Industry leading total piping length up to 510m and a maximum pipe run of 160m.

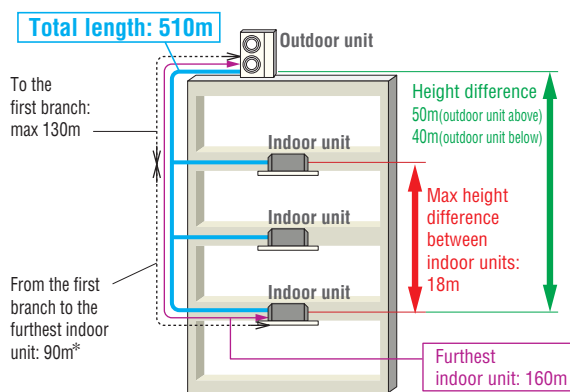

* The difference between the longest and the shortest indoor unit piping from the first branch must be within 40m.

Range of operation

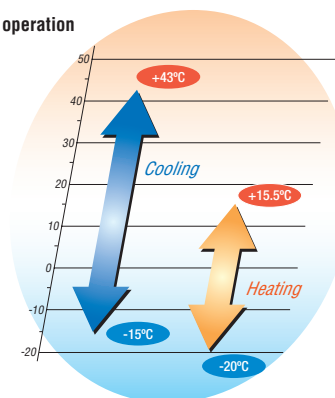

Specifications

Item		Model	FDC224KXE6G	FDC280KXE6G	FDC335KXE6G
Nominal horse power			8HP	10HP	12HP
Power source			3 Phase 380-415V, 50Hz		
Starting current		A	5		
Max current		A	20		
Nominal capacity	Cooling	kW	22.4	28.0	33.5
	Heating	kW	25.0	31.5	37.5
Electrical characteristics	Power consumption	Cooling	5.60	8.09	9.82
		Heating	6.03	8.21	10.12
Exterior dimensions		HxWxD	1675x1080x480		
Net weight		kg	221		
Sound pressure level		Cooling/Heating	58/58	59/60	61/61
Refrigerant	Type / GWP		R410A / 2088		
	Charge	kg/TCO ₂ Eq	11.5 / 24.012		
Refrigerant piping size	Liquid line	mm(in)	ø9.52(3/8")		
	Gas line	mm(in)	ø19.05(3/4")	ø22.22(7/8")	ø25.4(1") [ø22.22(7/8")]
Capacity connection		%	50~150		
Number of connectable indoor units			22	24	24

1. The data are measured under the following conditions(ISO-T1). Cooling: Indoor temp. of 27°CDB, 19°CWB, and outdoor temp. of 35°CDB. Heating: Indoor temp. of 20°CDB, and outdoor temp. of 7°CDB, 6°CWB. Piping length is 7.5m.
 2. Sound pressure level indicates the value in an anechoic chamber. During operation these values are somewhat higher due to ambient conditions.
 3. 'tonne(s) of CO₂ equivalent' means a quantity of greenhouse gases- expressed as the product of the weight of the greenhouse gases in metric tonnes and of their global warming potential.
 4. [] : Pipe sizes applicable to European installations are shown in parentheses.

Refrigerant piping

Outdoor unit (HP)		8	10	12
Gas pipe	Furthest indoor unit =<90m	ø19.05	ø22.22	ø25.4(ø22.22)
Liquid pipe		ø9.52		ø12.7
Gas pipe	90m	ø22.22	ø25.4(ø22.22)	
Liquid pipe	=<Furthest indoor unit	ø12.7		

Branch pipes



DIS-22-1G
DIS-180-1G



DIS-371-1G

Header pipe



HEAD4-22-1G
HEAD6-180-1G
HEAD8-371-2

Dimensions

All measurements in mm.

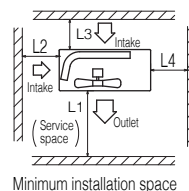
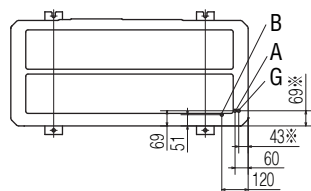

	I	II	II
L1	Open	Open	1500
L2	300	5	Open
L3	300	300	300
L4	5	5	5

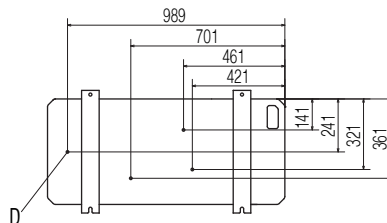
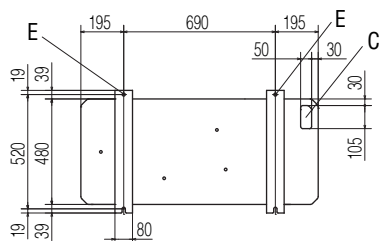
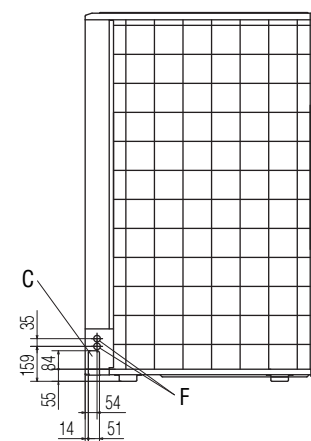
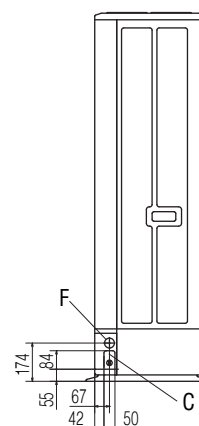
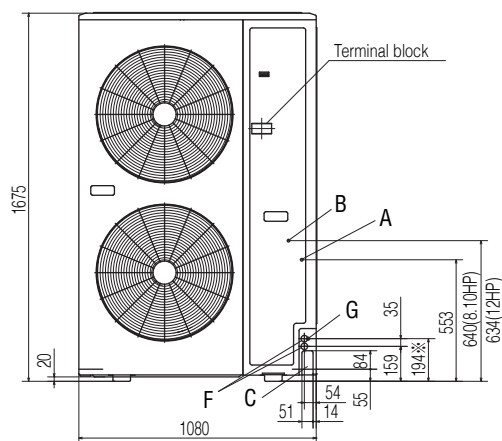
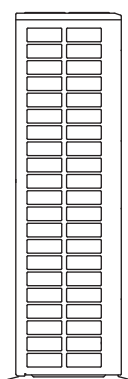

Mark	Content	224	280	335
A	Service valve connection of the attached connecting pipe (gas side)	ø19.05 (3/4") (Flare)	ø19.05 (3/4") (Flare)	ø19.05 (3/4") (Flare)
B	Service valve connection (liquid side)	ø9.52 (3/8") (Flare)	ø9.52 (3/8") (Flare)	ø12.7 (1/2") (Flare)
C	Pipe/cable draw-out hole	4places	4places	4places
D	Drain discharge hole	ø20 × 4places	ø20 × 4places	ø20 × 4places
E	Anchor bolt hole	M10 × 4places	M10 × 4places	M10 × 4places
F	Cable draw-out hole	ø30 × 2places (front) ø45 (side) ø30 × 2places (back)	ø30 × 2places (front) ø30 × 2places (side) ø30 × 2places (back)	ø30 × 2places (front) ø45 (side) ø30 × 2places (back)
G	Connecting position of the local pipe. (gas side)	ø19.05 (3/4")(Brazing)	ø22.22 (7/8")(Brazing)	ø25.4 (1")(Brazing)

Notes:

- (1) It must not be surrounded by walls on the four sides.
- (2) The unit must be fixed with anchor bolts. An anchor bolt must not protrude more than 15mm.
- (3) Where the unit is subject to strong winds, the blower outlet should face perpendicularly to the dominant wind direction.
- (4) Leave a 1m or more space above the unit.
- (5) A wall in front of the blower outlet must not exceed the units height.
- (6) The model name label is attached on the lower right corner of the front.
- (7) Connect the Service valve with local pipe by using the pipe of the attachment.(Gas side only)
- (8) Mark ※ shows the connecting position of the local pipe.(Gas side only)



KXZ Lite Heat pump systems

8, 10HP (22.4kW - 28.0kW)

Model No.	Nominal Cooling Capacity
FDC224KXZPE1	22.4kW
FDC280KXZPE1	28.0kW



- Connect up to 8 indoor units/up to 120% capacity.
- High efficiency with COP (in cooling) up to 4.0.
- These units employ DC inverter multiport compressors with concentrated winding motor.
- KXZ Lite extends a cooling range operation up to 50°C.
- External static pressure is available up to 35 Pa.
- Tropical usage mode.

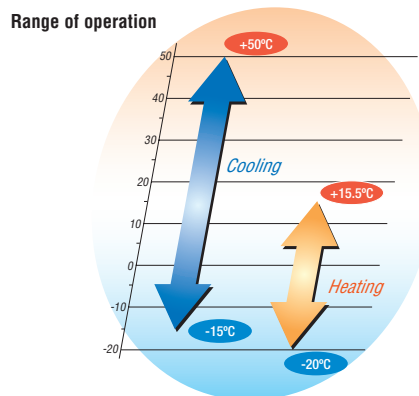
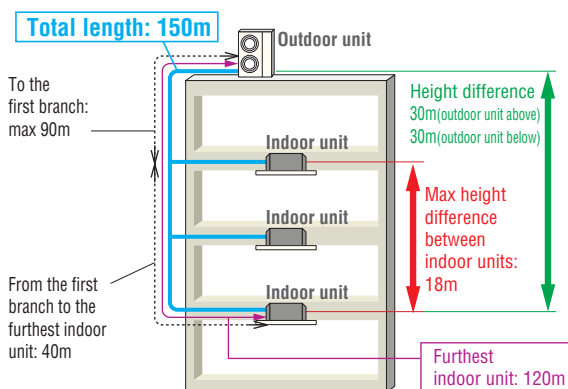

Specifications

Item	Model	FDC224KXZPE1	FDC280KXZPE1
Nominal horse power		8HP	10HP
Power source		3 Phase 380-415V, 50Hz	
Starting current	A	5	
Max current	A	21	22
Nominal capacity	Cooling	22.4	28.0
	Heating	22.4	28.0
Electrical characteristics	Power consumption	Cooling	5.6
		Heating	4.8
Exterior dimensions	HxWxD	mm 1505x970x370	
Net weight	kg	165	
Sound pressure level	Cooling/Heating	dB(A) 59/60	60/63
Refrigerant	Type / GWP	R410A / 2088	
	Charge	kg/TCO ₂ Eq 8.9 / 18.583	
Refrigerant piping size	Liquid line	mm(in) ø9.52(3/8")	
	Gas line	ø19.05(3/4") ø22.22(7/8")	
Capacity connection	%	50~120	
Number of connectable indoor units		8	8

1. The data are measured under the following conditions (ISO-T1). Cooling: Indoor temp. of 27°CDB, 19°CWB, and outdoor temp. of 35°CDB. Heating: Indoor temp. of 20°CDB, and outdoor temp. of 7°CDB, 6°CWB. Piping length is 7.5m.
 2. Sound pressure level indicates the value in an anechoic chamber. During operation these values are somewhat higher due to ambient conditions.
 3. 'tonne(s) of CO₂ equivalent' means a quantity of greenhouse gases- expressed as the product of the weight of the greenhouse gases in metric tonnes and of their global warming potential.

Refrigerant piping

Outdoor unit (HP)		8	10
Gas pipe	Furthest indoor unit =<90m	ø19.05	ø22.22
Liquid pipe		ø9.52	
Gas pipe	90m	ø22.22	ø25.4/ø28.58
Liquid pipe	=<Furthest indoor unit	ø9.52	

Branch pipes



DIS-22-1G
DIS-180-1G

Header pipe



HEAD4-22-1G
HEAD6-180-1G

Dimensions

All measurements in mm.

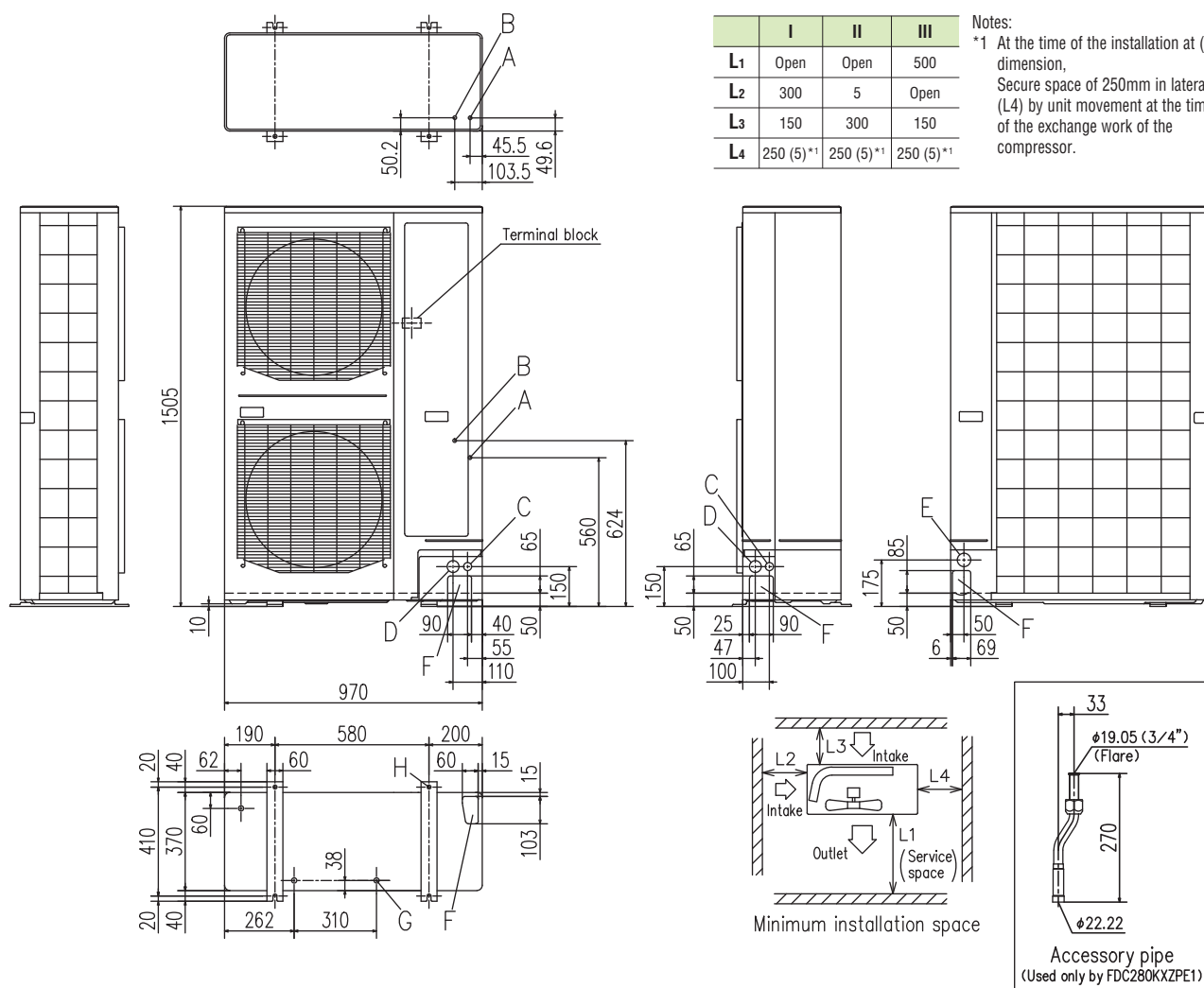

Mark	Content	
A	Service valve connection of the attached connecting pipe (gas side)	ø19.05 (3/4") (Flare)
B	Service valve connection (liquid side)	ø9.52 (3/8") (Flare)
C	Cable draw-out hole (front · side)	ø30 × 2places
D	Cable draw-out hole (front · side)	ø45 × 2places
E	Cable draw-out hole (back)	ø50
F	Pipe/cable draw-out hole	4places
G	Drain discharge hole	ø20 × 3places
H	Anchor bolt hole	M10 × 4places

Notes:

- (1) It must not be surrounded by walls on the four sides.
- (2) The unit must be fixed with anchor bolts.
An anchor bolt must not protrude more than 15mm.
- (3) Where the unit is subject to strong winds, lay it in such a direction that the blower outlet faces perpendicularly to the dominant wind direction.
- (4) Leave 1m or more space above the unit.
- (5) A wall in front of the blower outlet must not exceed the units height.
- (6) The model name label is attached on the lower right corner of the front panel.
- (7) Connect the Service valve with local pipe by using the pipe of the attachment.
(Gas side only) (Accessory pipe is used only by FDC280KXZPE1)
- (8) Regarding attaching the pipe of accessories, refer to an attached installation manual.



KXZ Heat pump systems

10, 12HP (28.0kW, 33.5kW)

Model No.	Nominal Cooling Capacity
FDC280KXZE1	28.0kW
FDC335KXZE1	33.5kW

- Connect up to 29 indoor units/up to 130% capacity.
- High efficiency with COP (in cooling) up to 3.9.
- These units employ DC inverter multiport compressors with concentrated winding motor.
- Industry leading total piping length up to 1000m and a maximum pipe run of 160m.



Uniform footprint of models (10,12HP) allows continuous side-by-side installation

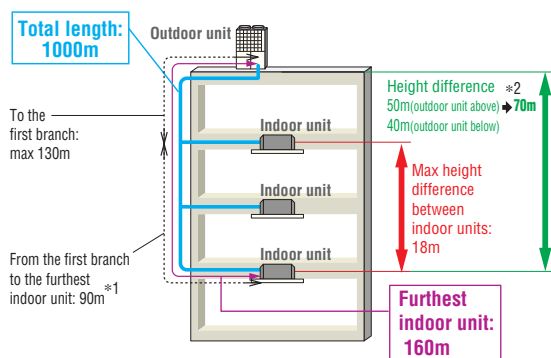

- *1 The difference between the longest and the shortest indoor unit piping from the first branch must be within 40m. (MAX85m)
- *2 In case of height difference up to 70m, please contact your dealer. Height difference up to 90m is possible with High Head series. Please refer to page 56.

Range of operation

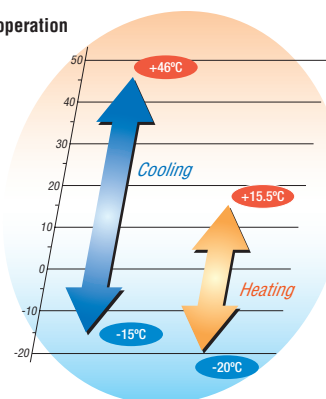

Specifications

Item	Model	FDC280KXZE1	FDC335KXZE1
Nominal horse power		10HP	12HP
Power source		3 Phase 380-415V, 50Hz	
Starting current	A	5	
Max current	A	21.2	
Nominal capacity	Cooling	28.0	33.5
	Heating	31.5	37.5
Electrical characteristics	Power consumption	Cooling	7.24
		Heating	7.28
Exterior dimensions	HxWxD	1690x1350x720	
Net weight	kg	272	
Sound pressure level	Cooling/Heating	55/57	61/58
Refrigerant	Type / GWP	R410A / 2088	
	Charge	11.0 / 22.968	
Refrigerant piping size	Liquid line	$\phi 9.52(3/8")$	$\phi 12.7(1/2")$
	Gas line	$\phi 22.22(7/8")$	$\phi 25.4(1")$ [$\phi 22.22(7/8")$]
Capacity connection	%	50~130	
Number of connectable indoor units		24	29

1. The data are measured under the following conditions(ISO-T1). Cooling: Indoor temp. of 27°CDB, 19°CWB, and outdoor temp. of 35°CDB. Heating: Indoor temp. of 20°CDB, and outdoor temp. of 7°CDB, 6°CWB. Piping length is 7.5m.
 2. Sound pressure level indicates the value in an anechoic chamber. During operation these values are somewhat higher due to ambient conditions.
 3. 'tonne(s) of CO2 equivalent' means a quantity of greenhouse gases- expressed as the product of the weight of the greenhouse gases in metric tonnes and of their global warming potential.
 4. [] : Pipe sizes applicable to European installations are shown in parentheses.

Dimensions

All measurements in mm.

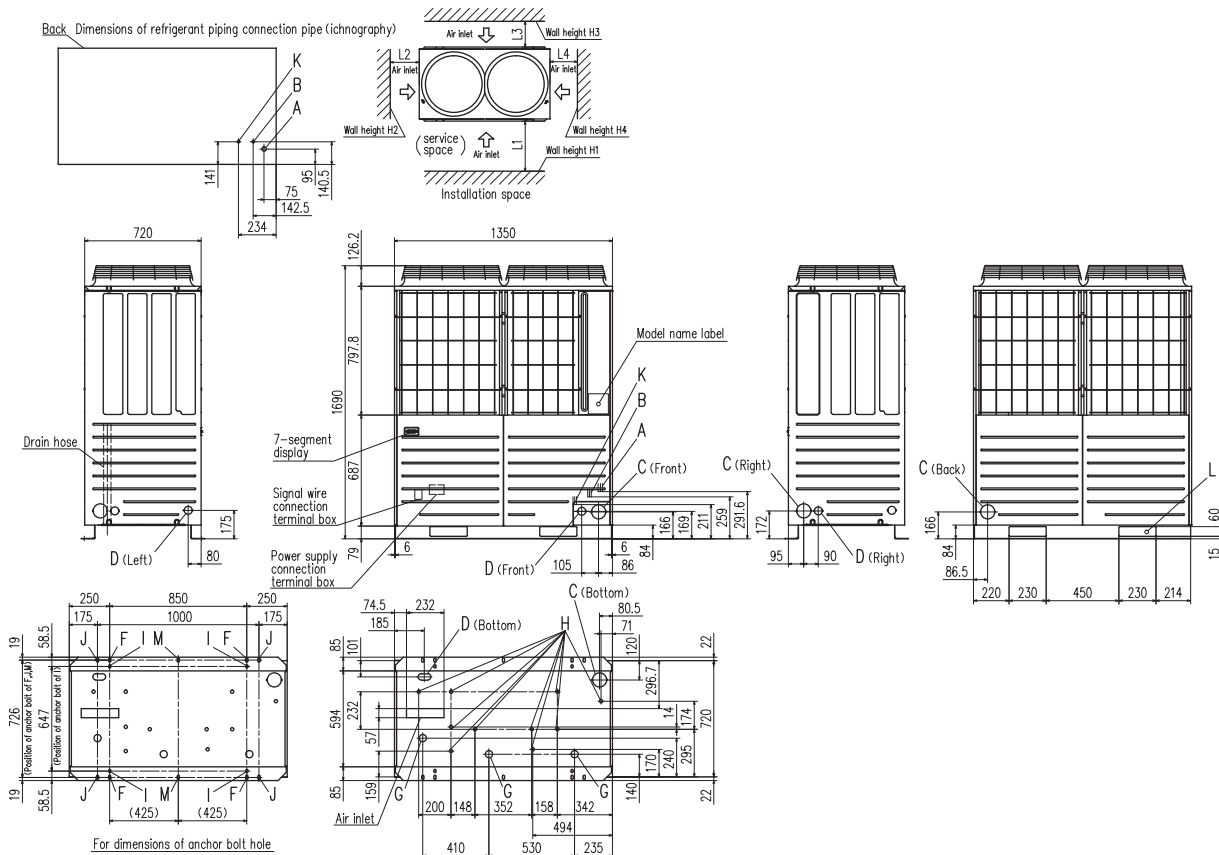

Mark	Content	280	335
A	Refrigerant gas piping connection pipe	ø22.22(Brazing)	ø25.4(Brazing)
B	Refrigerant liquid piping connection pipe	ø9.52(Flare)	ø12.7(Flare)
C	Refrigerant piping exit hole	ø88(or ø100)	
D	Power supply entry hole	ø50 (right · left · front), long hole 40 x 80 (bottom)	
F	Anchor bolt hole	M10 x 4 places	
G	Drain waste water hose hole	ø45 x 3 places	
H	Drain hole	ø20 x 10 places	
K	Refrigerant oil equalization piping connection pipe	ø9.52(Flare)	
L	Carrying in or hole for hanging	230 x 60	

Installation example		
Dimensions	1	2
L ₁	500	Open
L ₂	10(30)	10(30)
L ₃	100	100
L ₄	10(30)	Open
H ₁	1500	Open
H ₂	No limit	No limit
H ₃	1000	No limit
H ₄	No limit	Open

(): In case it is the promised installation location that the outdoor unit is used on conditions with the ambient temperature of 43°C or more.

When more than one unit is installed

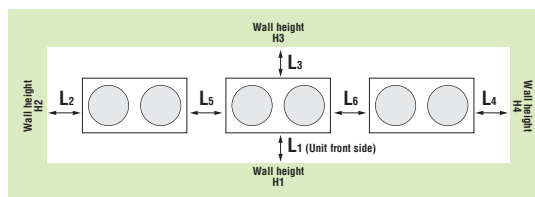

Installation example		
Dimensions	1	2
L ₁	500	Open
L ₂	10(30)	200
L ₃	100	300
L ₄	10(30)	Open
L ₅	10(30)	400
L ₆	10(30)	400
H ₁	1500	Open
H ₂	No limit	No limit
H ₃	1000	No limit
H ₄	No limit	Open

(): In case it is the promised installation location that the outdoor unit is used on conditions with the ambient temperature of 43°C or more.



KXZ Heat pump systems

14, 16, 17, 18, 20HP (40.0kW~56.0kW)

Model No.	Nominal Cooling Capacity
FDC400KXZE1	40.0kW
FDC450KXZE1	45.0kW
FDC475KXZE1	47.5kW
FDC500KXZE1	50.0kW
FDC560KXZE1	56.0kW

- Connect up to 48 indoor units/up to 130% capacity.
- High efficiency with COP (in cooling) up to 3.6.
- These units employ DC inverter multiport compressors with concentrated winding motor.
- Industry leading total piping length up to 1000m and a maximum pipe run of 160m.



Uniform footprint of all models (from 14HP~20HP) allows continuous side-by-side installation

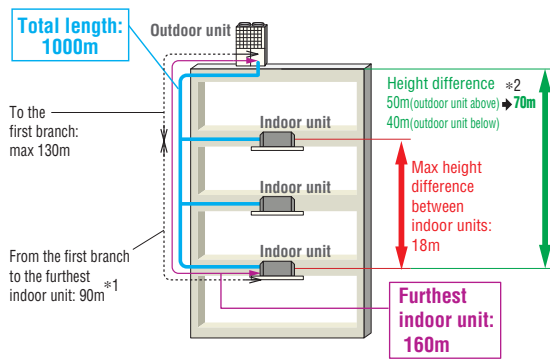

- *1 The difference between the longest and the shortest indoor unit piping from the first branch must be within 40m. (MAX85m)
 *2 In case of height difference up to 70m, please contact your dealer. Height difference up to 90m is possible with High Head series. Please refer to page 56.

Range of operation

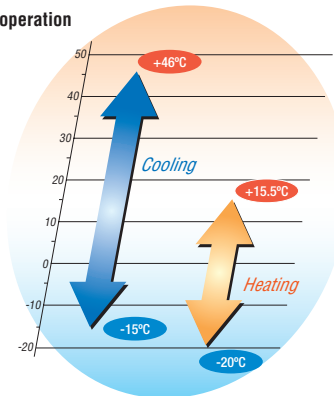

Specifications

Item	Model	FDC400KXZE1	FDC450KXZE1	FDC475KXZE1	FDC500KXZE1	FDC560KXZE1	
Nominal horse power		14HP	16HP	17HP	18HP	20HP	
Power source		3 Phase 380-415V, 50Hz					
Starting current	A	5			8		
Max current	A	32			42.4		
Nominal capacity	Cooling	40.0	45.0	47.5	50.0	56.0	
	Heating	45.0	50.0	53.0	56.0	63.0	
Electrical characteristics	Power consumption	Cooling	10.96	13.98	13.98	13.97	16.62
		Heating	10.69	12.50	13.00	13.49	15.95
Exterior dimensions	HxWxD	mm 2048x1350x720					
Net weight	kg	317			370		
Sound pressure level	Cooling/Heating	60/62	61/62	61/61	61/62	64/66	
Refrigerant	Type / GWP	R410A / 2088					
	Charge	kg/TCO ₂ Eq 11.5 / 24.012					
Refrigerant piping size	Liquid line	mm(in) ø12.7(1/2")					
	Gas line	ø25.4(1") [ø28.58(1 1/8")] ø28.58(1 1/8")					
Capacity connection	%	50~130					
Number of connectable indoor units		34	39	41	43	48	

1. The data are measured under the following conditions (ISO-T1). Cooling: Indoor temp. of 27°CDB, 19°CWB, and outdoor temp. of 35°CDB. Heating: Indoor temp. of 20°CDB, and outdoor temp. of 7°CDB, 6°CWB. Piping length is 7.5m.
 2. Sound pressure level indicates the value in an anechoic chamber. During operation these values are somewhat higher due to ambient conditions.
 3. 'tonne(s) of CO₂ equivalent' means a quantity of greenhouse gases- expressed as the product of the weight of the greenhouse gases in metric tonnes and of their global warming potential.
 4. [] : Pipe sizes applicable to European installations are shown in parentheses.

Dimensions

All measurements in mm.

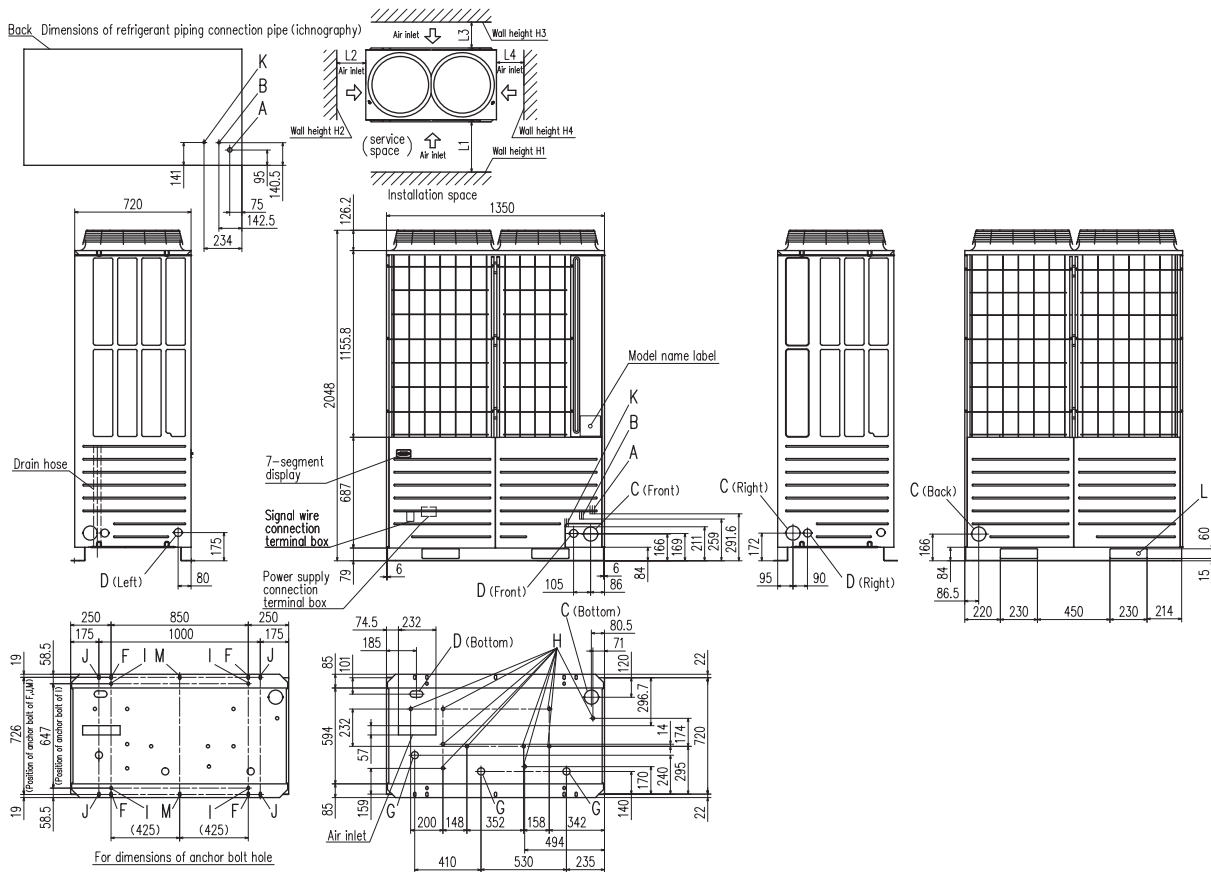

Mark	Content	400	450, 475, 500, 560
A	Refrigerant gas piping connection pipe	ø25.4(Brazing)	ø28.58(Brazing)
B	Refrigerant liquid piping connection pipe	ø12.7(Flare)	
C	Refrigerant piping exit hole	ø88(or ø100)	
D	Power supply entry hole	ø50 (right · left · front), long hole 40 x 80 (bottom)	
F	Anchor bolt hole	M10 x 4 places	
G	Drain waste water hose hole	ø45 x 3 places	
H	Drain hole	ø20 x 10 places	
K	Refrigerant oil equalization piping connection pipe	ø9.52(Flare)	
L	Carrying in or hole for hanging	230 x 60	

Installation example			
Dimensions	1	2	
L ₁	500	Open	
L ₂	10(30)	10(30)	
L ₃	100	100	
L ₄	10(30)	Open	
H ₁	1500	Open	
H ₂	No limit	No limit	
H ₃	1000	No limit	
H ₄	No limit	Open	

(): In case it is the promised installation location that the outdoor unit is used on conditions with the ambient temperature of 43°C or more.

When more than one unit is installed

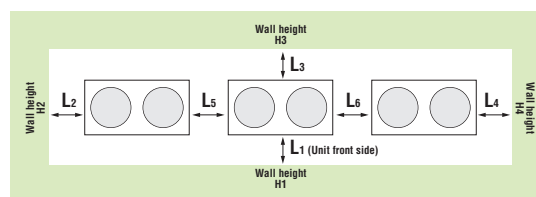

Installation example			
Dimensions	1	2	
L ₁	500	Open	
L ₂	10(30)	200	
L ₃	100	300	
L ₄	10(30)	Open	
L ₅	10(30)	400	
L ₆	10(30)	400	
H ₁	1500	Open	
H ₂	No limit	No limit	
H ₃	1000	No limit	
H ₄	No limit	Open	

(): In case it is the promised installation location that the outdoor unit is used on conditions with the ambient temperature of 43°C or more.



KXZ Heat pump combination systems

22, 24HP (61.5kW, 67.0kW)



Model No.	Nominal Cooling Capacity
FDC615KXZE1 (FDC280+FDC335)	61.5kW
FDC670KXZE1 (FDC335+FDC335)	67.0kW

- Connect up to 58 indoor units/up to 130% capacity.
- High efficiency with COP (in cooling) up to 3.8.
- These units employ DC inverter multiport compressors with concentrated winding motor.
- Industry leading total piping length up to 1000m and a maximum pipe run of 160m.

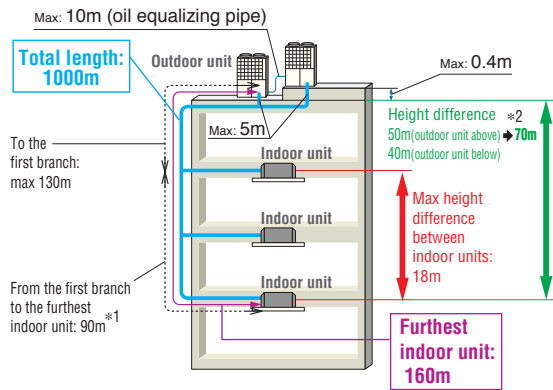

*1 The difference between the longest and the shortest indoor unit piping from the first branch must be within 40m. (MAX85m)
 *2 In case of height difference up to 70m, please contact your dealer. Height difference up to 90m is possible with High Head series. Please refer to page 56.



Uniform footprint of all models (from 22HP, 24HP) allows continuous side-by-side installation

Range of operation

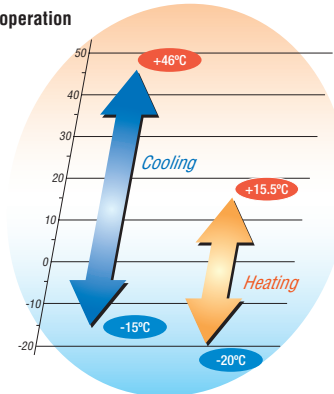

Specifications

Exterior dimension : Please refer to page37.

Item		Model	FDC615KXZE1	FDC670KXZE1
Combination (FDC)			280KXZE1 335KXZE1	335KXZE1 335KXZE1
Nominal horse power			22HP	24HP
Power source			3 Phase 380-415V, 50Hz	
Starting current		A	10	
Max current		A	42.4	
Nominal capacity	Cooling	kW	61.5	67.0
	Heating	kW	69.0	75.0
Electrical characteristics	Power consumption	Cooling	16.20	17.92
		Heating	16.32	18.08
Exterior dimensions		HxWxD	mm 1690x2700x720	
Net weight		kg	544	
Refrigerant charge		R410A	kg 11.0x2	
Refrigerant piping size	Liquid line	mm(in)	ø12.7(1/2")	
	Gas line	mm(in)	ø28.58(1 1/8")	
Capacity connection		%	50~130	
Number of connectable indoor units			53	58

1. The data are measured under the following conditions (ISO-T1). Cooling: Indoor temp. of 27°CDB, 19°CWB, and outdoor temp. of 35°CDB. Heating: Indoor temp. of 20°CDB, and outdoor temp. of 7°CDB, 6°CWB. Piping length is 7.5m.
 2. Sound pressure level indicates the value in an anechoic chamber. During operation these values are somewhat higher due to ambient conditions.

KXZ Heat pump combination systems

26, 28, 30, 32, 34, 36, 38, 40HP (73.5kW~112.0kW)

Model No.	Nominal Cooling Capacity
FDC735KXZE1 (FDC335+FDC400)	73.5kW
FDC800KXZE1 (FDC400+FDC400)	80.0kW
FDC850KXZE1 (FDC400+FDC450)	85.0kW
FDC900KXZE1 (FDC450+FDC450)	90.0kW
FDC950KXZE1 (FDC475+FDC475)	95.0kW
FDC1000KXZE1 (FDC500+FDC500)	100.0kW
FDC1060KXZE1 (FDC500+FDC560)	106.0kW
FDC1120KXZE1 (FDC560+FDC560)	112.0kW

- Connect up to 80 indoor units/up to 130% capacity.
- High efficiency with COP (in cooling) up to 3.7.
- These units employ DC inverter multiport compressors with concentrated winding motor.
- Industry leading total piping length up to 1000m and a maximum pipe run of 160m.



• In case of 26HP

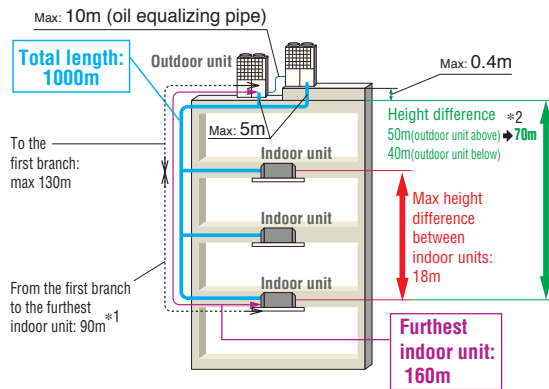

- *1 The difference between the longest and the shortest indoor unit piping from the first branch must be within 40m. (MAX85m)
- *2 In case of height difference up to 70m, please contact your dealer. Height difference up to 90m is possible with High Head series. Please refer to page 56.

Range of operation

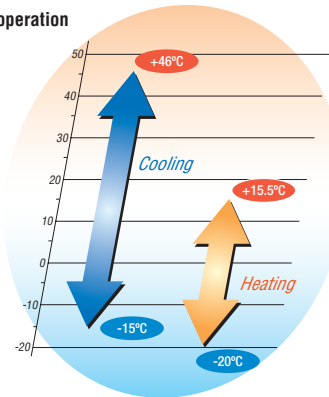

Specifications

Exterior dimension : Please refer to page37,39.

Item	Model	FDC735KXZE1	FDC800KXZE1	FDC850KXZE1	FDC900KXZE1	FDC950KXZE1	FDC1000KXZE1	FDC1060KXZE1	FDC1120KXZE1	
		Combination (FDC)	335KXZE1 400KXZE1	400KXZE1 400KXZE1	400KXZE1 450KXZE1	450KXZE1 450KXZE1	475KXZE1 475KXZE1	500KXZE1 500KXZE1	500KXZE1 560KXZE1	560KXZE1 560KXZE1
Nominal horse power		26HP	28HP	30HP	32HP	34HP	36HP	38HP	40HP	
Power source		3 Phase 380-415V, 50Hz								
Starting current	A	10				16				
Max current	A	53.2	64		84.8					
Nominal capacity	Cooling	kW								
	Heating	kW								
Electrical characteristics	Power consumption	Cooling	kW							
		Heating	kW							
Exterior dimensions	HxWxD	mm								
Net weight	kg	589	634		740					
Refrigerant charge	R410A	kg		11.5x2						
Refrigerant piping size	Liquid line	mm(in)						mm(in)		
	Gas line	mm(in)						mm(in)		
Capacity connection	%	50~130								
Number of connectable indoor units		63	69	73	78	80				

1. The data are measured under the following conditions (ISO-T1). Cooling: Indoor temp. of 27°CDB, 19°CWB, and outdoor temp. of 35°CDB. Heating: Indoor temp. of 20°CDB, and outdoor temp. of 7°CDB, 6°CWB. Piping length is 7.5m.
 2. Sound pressure level indicates the value in an anechoic chamber. During operation these values are somewhat higher due to ambient conditions.
 3. [] : Pipe sizes applicable to European installations are shown in parentheses.



KXZ Heat pump combination systems

42, 44, 46, 48HP (120.0kW~135.0kW)

Model No.	Nominal Cooling Capacity
FDC1200KXZE1 (FDC400+FDC400+FDC400)	120.0kW
FDC1250KXZE1 (FDC400+FDC400+FDC450)	125.0kW
FDC1300KXZE1 (FDC400+FDC450+FDC450)	130.0kW
FDC1350KXZE1 (FDC450+FDC450+FDC450)	135.0kW



- Connect up to 80 indoor units/up to 130% capacity.
- High efficiency with COP (in cooling) up to 3.6.
- These units employ DC inverter multiport compressors with concentrated winding motor.
- Industry leading total piping length up to 1000m and a maximum pipe run of 160m.

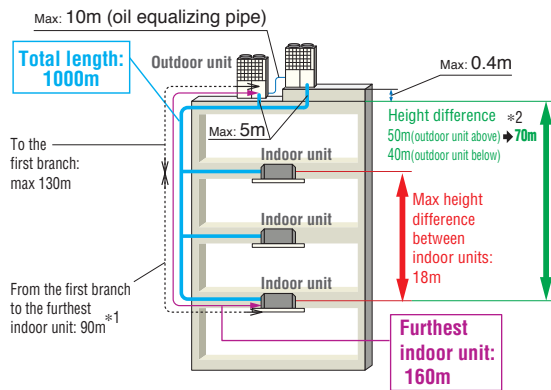

*1 The difference between the longest and the shortest indoor unit piping from the first branch must be within 40m. (MAX85m)
 *2 In case of height difference up to 70m, please contact your dealer. Height difference up to 90m is possible with High Head series. Please refer to page 56.

Range of operation

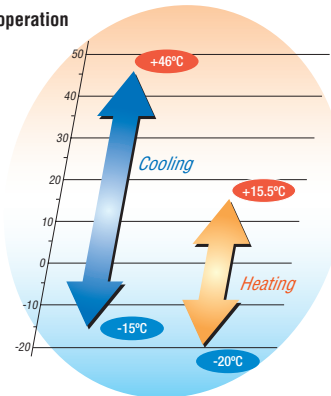

Specifications

Exterior dimension : Please refer to page39.

Item	Model	FDC1200KXZE1	FDC1250KXZE1	FDC1300KXZE1	FDC1350KXZE1	
Combination (FDC)		400KXZE1	400KXZE1	400KXZE1	450KXZE1	
		400KXZE1	400KXZE1	450KXZE1	450KXZE1	
		400KXZE1	450KXZE1	450KXZE1	450KXZE1	
Nominal horse power		42HP	44HP	46HP	48HP	
Power source		3 Phase 380-415V, 50Hz				
Starting current	A	15				
Max current	A	96				
Nominal capacity	Cooling	120.0	125.0	130.0	135.0	
	Heating	135.0	140.0	145.0	150.0	
Electrical characteristics	Power consumption	Cooling	32.88	35.90	38.92	41.94
		Heating	32.07	33.88	35.69	37.50
Exterior dimensions	HxWxD	mm 2048x4050x720				
Net weight	kg	951				
Refrigerant charge	R410A	kg 11.5x3				
Refrigerant piping size	Liquid line	mm(in) ø19.05(3/4")				
	Gas line	mm(in) ø38.1(1 1/2") [ø34.92(1 3/8")]				
Capacity connection	%	50-130				
Number of connectable indoor units		80				

1. The data are measured under the following conditions(ISO-T1). Cooling: Indoor temp. of 27°CDB, 19°CWB, and outdoor temp. of 35°CDB. Heating: Indoor temp. of 20°CDB, and outdoor temp. of 7°CDB, 6°CWB. Piping length is 7.5m.
 2. Sound pressure level indicates the value in an anechoic chamber. During operation these values are somewhat higher due to ambient conditions.
 3. [] : Pipe sizes applicable to European installations are shown in parentheses.

KXZ Heat pump combination systems

50, 52, 54, 56, 58, 60HP (142.5kW~168.0kW)



Model No.	Nominal Cooling Capacity
FDC1425KXZE1 (FDC475+FDC475+FDC475)	142.5kW
FDC1450KXZE1 (FDC475+FDC475+FDC500)	145.0kW
FDC1500KXZE1 (FDC500+FDC500+FDC500)	150.0kW
FDC1560KXZE1 (FDC500+FDC500+FDC560)	156.0kW
FDC1620KXZE1 (FDC500+FDC560+FDC560)	162.0kW
FDC1680KXZE1 (FDC560+FDC560+FDC560)	168.0kW

- Connect up to 80 indoor units/up to 130% capacity.
- High efficiency with COP (in cooling) up to 3.6.
- These units employ DC inverter multiport compressors with concentrated winding motor.
- Industry leading total piping length up to 1000m and a maximum pipe run of 160m.

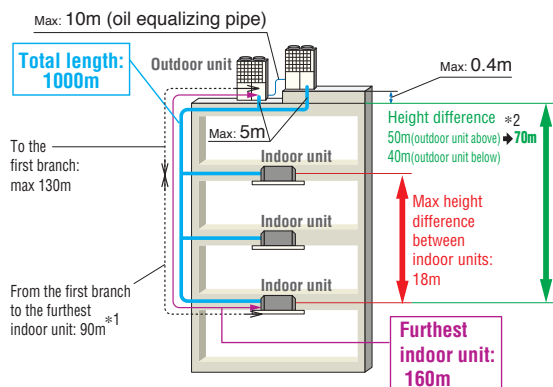

*1 The difference between the longest and the shortest indoor unit piping from the first branch must be within 40m. (MAX85m)
 *2 In case of height difference up to 70m, please contact your dealer. Height difference up to 90m is possible with High Head series. Please refer to page 56.

Range of operation

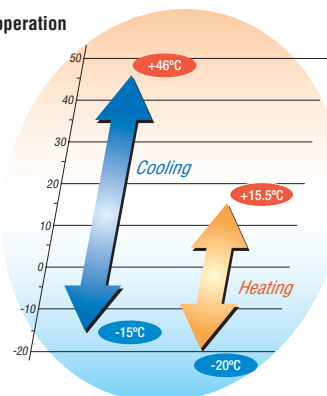

Specifications

Exterior dimension : Please refer to page39.

Item	Model	FDC1425KXZE1	FDC1450KXZE1	FDC1500KXZE1	FDC1560KXZE1	FDC1620KXZE1	FDC1680KXZE1
		Combination (FDC)	475KXZE1	475KXZE1	500KXZE1	500KXZE1	500KXZE1
		475KXZE1	475KXZE1	500KXZE1	500KXZE1	560KXZE1	560KXZE1
		475KXZE1	500KXZE1	500KXZE1	560KXZE1	560KXZE1	560KXZE1
Nominal horse power		50HP	52HP	54HP	56HP	58HP	60HP
Power source		3 Phase 380-415V, 50Hz					
Starting current	A	24					
Max current	A	127.2					
Nominal capacity	Cooling	kW					
	Heating	kW					
Electrical characteristics	Power consumption	kW					
	Cooling/Heating	kW					
Exterior dimensions	HxWxD	mm					
Net weight		kg					
Refrigerant charge	R410A	kg					
Refrigerant piping size	Liquid line	mm(in)					
	Gas line	mm(in)					
Capacity connection		%					
Number of connectable indoor units							

1. The data are measured under the following conditions (ISO-T1). Cooling: Indoor temp. of 27°CDB, 19°CWB, and outdoor temp. of 35°CDB. Heating: Indoor temp. of 20°CDB, and outdoor temp. of 7°CDB, 6°CWB. Piping length is 7.5m.
 2. Sound pressure level indicates the value in an anechoic chamber. During operation these values are somewhat higher due to ambient conditions.
 3. [] : Pipe sizes applicable to European installations are shown in parentheses.



KXZ Hi-COP series

8~36HP(22.4kW~100.0kW)

Model No.	Nominal Cooling Capacity
FDC224KXZXE1	22.4kW
FDC280KXZXE1	28.0kW
FDC335KXZXE1	33.5kW

Model No.	Nominal Cooling Capacity
FDC450KXZXE1 (FDC224+FDC224)	45.0kW
FDC500KXZXE1 (FDC224+FDC280)	50.0kW
FDC560KXZXE1 (FDC280+FDC280)	56.0kW
FDC615KXZXE1 (FDC280+FDC335)	61.5kW
FDC670KXZXE1 (FDC335+FDC335)	67.0kW
FDC735KXZXE1 (FDC224+FDC224+FDC280)	73.5kW
FDC800KXZXE1 (FDC224+FDC280+FDC280)	80.0kW
FDC850KXZXE1 (FDC280+FDC280+FDC280)	85.0kW
FDC900KXZXE1 (FDC280+FDC280+FDC335)	90.0kW
FDC950KXZXE1 (FDC280+FDC335+FDC335)	95.0kW
FDC1000KXZXE1 (FDC335+FDC335+FDC335)	100.0kW

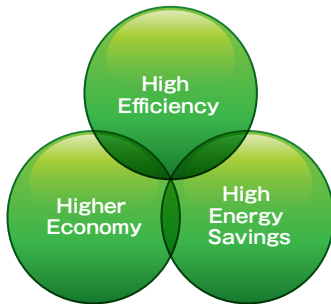

- This series can connect indoor unit capacity up to 160~200%.

kW	capacity connection
22.4~45.0	200%
50.0~100.0	160%

- High efficiency with COP (in cooling) up to 4.5.
- These units employ DC inverter multiport compressors with concentrated winding motor.
- Industry leading total piping length up to 1000m and a maximum pipe run of 160m.



FDC224KXZXE1



FDC280KXZXE1
FDC335KXZXE1

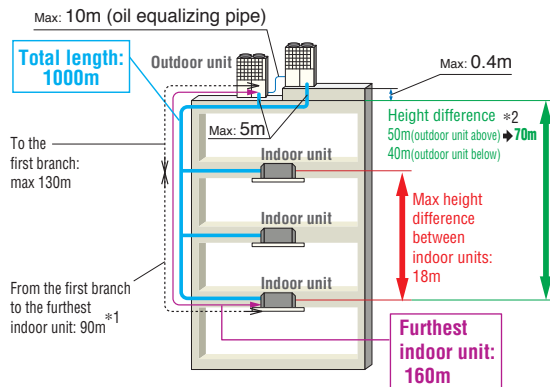

*1 The difference between the longest and the shortest indoor unit piping from the first branch must be within 40m. (MAX85m)
*2 In case of height difference up to 70m, please contact your dealer. Height difference up to 90m is possible with High Head series. Please refer to page 56.

Range of operation

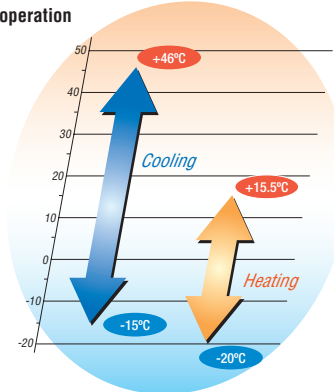

Specifications

Item	Model	FDC224KXZE1	FDC280KXZE1	FDC335KXZE1
Nominal horse power		8HP	10HP	12HP
Power source		3Phase 380-415V, 50Hz		
Starting current	A	5		
Max current	A	21.2	32	
Nominal capacity	Cooling	22.4	28.0	33.5
	Heating	25.0	31.5	37.5
Electrical characteristics	Power consumption	4.98	6.95	8.68
	Cooling Heating	5.56	6.83	8.39
Exterior dimensions	H x W x D	1690x1350x720	2048x1350x720	
Net weight	kg	280	325	
Sound pressure level	Cooling / Heating	56/57	56/56	62/57
Refrigerant	Type / GWP	R410A / 2088		
	Charge	11.0 / 22.968	11.5 / 24.012	
Refrigerant piping size	Liquid line	ø9.52(3/8")		
	Gas line	ø19.05(3/4")	ø22.22(7/8")	ø25.4(1") [ø22.22(7/8")]
Capacity connection	%	200		
Number of connectable indoor units		29	37	44

Item	Model	FDC450KXZE1	FDC500KXZE1	FDC560KXZE1	FDC615KXZE1	FDC670KXZE1
Combination (FDC)		224KXZE1	224KXZE1	280KXZE1	280KXZE1	335KXZE1
		224KXZE1	280KXZE1	280KXZE1	335KXZE1	335KXZE1
Nominal horse power		16HP	18HP	20HP	22HP	24HP
Power source		3Phase 380-415V, 50Hz				
Starting current	A	10				
Max current	A	42.4	53.2	64		
Nominal capacity	Cooling	45.0	50.0	56.0	61.5	67.0
	Heating	50.0	56.0	63.0	69.0	75.0
Electrical characteristics	Power consumption	10.0	11.8	13.9	15.6	17.4
	Cooling Heating	11.1	12.3	13.7	15.2	16.8
Exterior dimensions	H x W x D	1690x2700x720	2048x2700x720			
Net weight	kg	560	605	650	650	650
Refrigerant charge	R410A	11.0x2	11.0+11.5	11.5x2		
Refrigerant piping size	Liquid line	ø12.7(1/2")				
	Gas line	ø28.58(1 1/8")				
	Oil equalization	ø9.52(3/8")				
Capacity connection	%	200	160			
Number of connectable indoor units		60	53	59	65	71

Item	Model	FDC735KXZE1	FDC800KXZE1	FDC850KXZE1	FDC900KXZE1	FDC950KXZE1	FDC1000KXZE1
Combination (FDC)		224KXZE1	224KXZE1	280KXZE1	280KXZE1	280KXZE1	335KXZE1
		224KXZE1	280KXZE1	280KXZE1	280KXZE1	335KXZE1	335KXZE1
		280KXZE1	280KXZE1	280KXZE1	335KXZE1	335KXZE1	335KXZE1
Nominal horse power		26HP	28HP	30HP	32HP	34HP	36HP
Power source		3Phase 380-415V, 50Hz					
Starting current	A	15					
Max current	A	74.4	85.2	96			
Nominal capacity	Cooling	73.5	80.0	85.0	90.0	95.0	100.0
	Heating	82.5	90.0	95.0	100.0	106.0	112.0
Electrical characteristics	Power consumption	17.1	19.3	21.1	22.7	24.3	25.9
	Cooling Heating	18.2	19.7	20.6	21.9	23.5	25.1
Exterior dimensions	H x W x D	2048x4050x720					
Net weight	kg	885	930	975	975		
Refrigerant charge	R410A	11.0x2+11.5	11.0+11.5x2	11.5x3			
Refrigerant piping size	Liquid line	ø15.88(5/8")					
	Gas line	ø31.75(1 1/4") [ø34.92(1 3/8")]					
	Oil equalization	ø9.52(3/8")					
Capacity connection	%	160					
Number of connectable indoor units		78	80	80	80	80	80

1. The data are measured under the following conditions(ISO-T1). Cooling: Indoor temp. of 27°CDB, 19°CWB, and outdoor temp. of 35°CDB. Heating: Indoor temp. of 20°CDB, and outdoor temp. of 7°CDB, 6°CWB. Piping length is 7.5m.
2. Sound pressure level indicates the value in an anechoic chamber. During operation these values are somewhat higher due to ambient conditions.
3. "tonne(s) of CO2 equivalent" means a quantity of greenhouse gases- expressed as the product of the weight of the greenhouse gases in metric tonnes and of their global warming potential.
4. [] : Pipe sizes applicable to European installations are shown in parentheses.



Dimensions

All measurements in mm.

FDC224KXZXE1

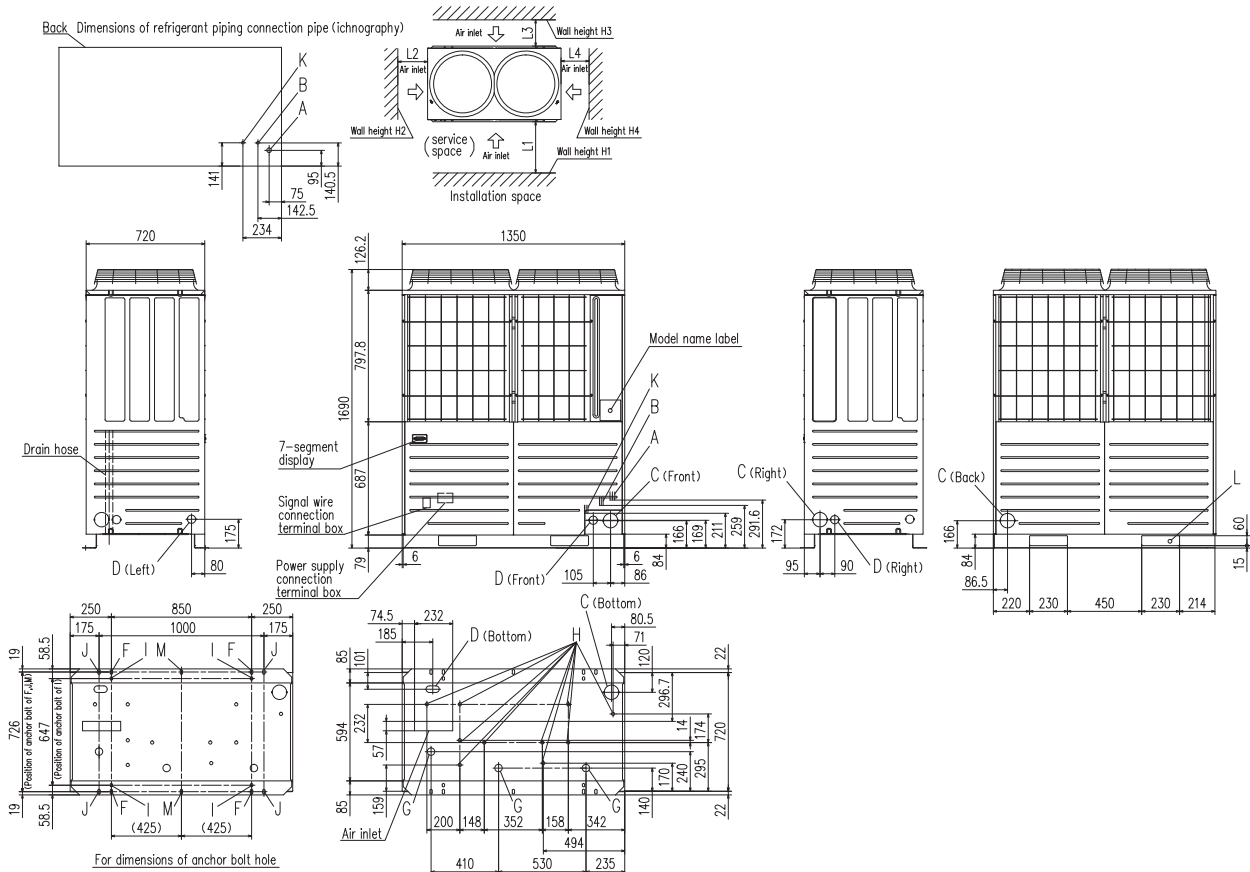

Mark	Content	224
A	Refrigerant gas piping connection pipe	ø19.05 (Brazing)
B	Refrigerant liquid piping connection pipe	ø9.52 (Flare)
C	Refrigerant piping exit hole	ø88 (or ø100)
D	Power supply entry hole	ø50 (Right · Left · Front), Long hole 40 x 80 (Bottom)
F	Anchor bolt hole	M10 x 4 places
G	Drain waste water hose hole	ø45 x 3 places
H	Drain hole	ø20 x 10 places
K	Refrigerant oil equalization piping connection pipe	ø9.52 (Flare)
L	Carrying in or hole for hanging	230 x 60

Installation example		
Dimensions	1	2
L ₁	500	Open
L ₂	10(30)	10(30)
L ₃	100	100
L ₄	10(30)	Open
H ₁	1500	Open
H ₂	No limit	No limit
H ₃	1000	No limit
H ₄	No limit	Open

() : In case it is the promised installation location that the outdoor unit is used on conditions with the ambient temperature of 43°C or more.

FDC280KXZXE1, 335KXZXE1

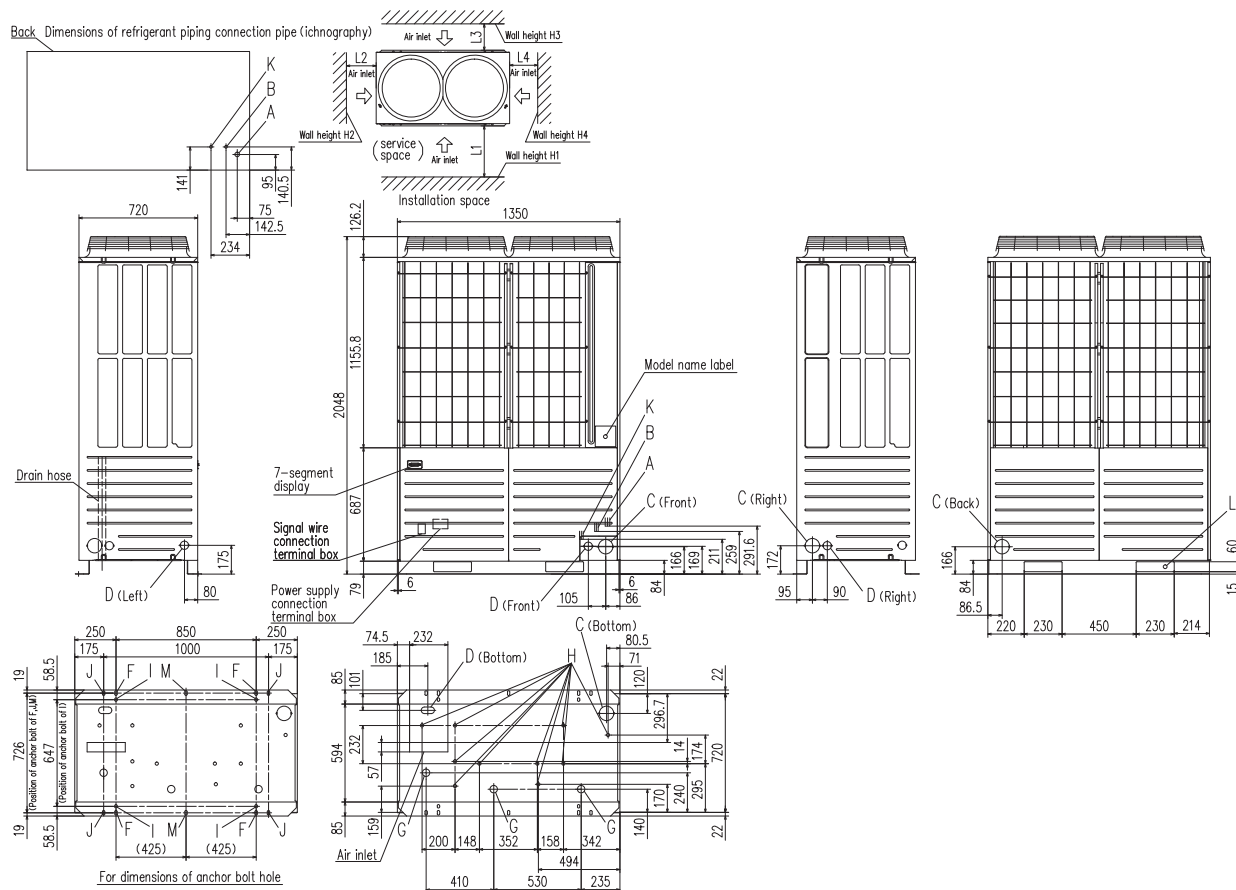

Mark	Content	280	335
A	Refrigerant gas piping connection pipe	ø22.22 (Brazing)	ø25.4 (Brazing)
B	Refrigerant liquid piping connection pipe	ø9.52 (Flare)	ø12.7 (Flare)
C	Refrigerant piping exit hole	ø88 (or ø100)	
D	Power supply entry hole	ø50 (Right · Left · Front), Long hole 40 x 80 (Bottom)	
F	Anchor bolt hole	M10 x 4 places	
G	Drain waste water hose hole	ø45 x 3 places	
H	Drain hole	ø20 x 10 places	
K	Refrigerant oil equalization piping connection pipe	ø9.52(Flare)	
L	Carrying in or hole for hanging	230 x 60	

Installation example		
Dimensions	1	2
L ₁	500	Open
L ₂	10(30)	10(30)
L ₃	100	100
L ₄	10(30)	Open
H ₁	1500	Open
H ₂	No limit	No limit
H ₃	1000	No limit
H ₄	No limit	Open

() :In case it is the promised installation location that the outdoor unit is used on conditions with the ambient temperature of 43°C or more.



Corrosion Protection Treatment series 4~60HP (11.2kW~168.0kW)

Corrosion Protection Treatment series are available with special coating applied for not only sheet metals but also small parts in order to prevent salt corrosion caused by sea breeze in area along coast line (Within approximately 500m from coast line).

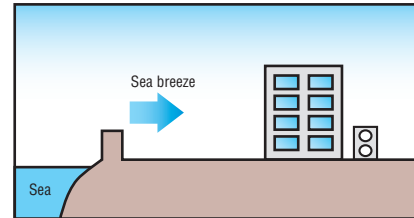

Model No.	Nominal Cooling Capacity
FDCS112KXEN6	11.2kW
FDCS112KXES6	11.2kW
FDCS140KXEN6	14.0kW
FDCS140KXES6	14.0kW
FDCS155KXEN6	15.5kW
FDCS155KXES6	15.5kW
FDCS224KXE6G	22.4kW
FDCS280KXE6G	28.0kW
FDCS335KXE6G	33.5kW

Model No.	Nominal Cooling Capacity
FDCS280KXZE1	28.0kW
FDCS335KXZE1	33.5kW
FDCS400KXZE1	40.0kW
FDCS450KXZE1	45.0kW
FDCS475KXZE1	47.5kW
FDCS504KXZE1	50.4kW
FDCS560KXZE1	56.0kW

- Combination systems: 22~60HP (61.5kW~168.0kW) are the same as that of the standard KXZ series shown on previous pages.
- Specifications and Dimensions are the same as that of the standard KXZ series shown on previous pages.
- Non-CE Marking models.



Corrosion resistance performance of high anticorrosion fin

Comparison of weight loss by corrosion

Neutral salt water spray test

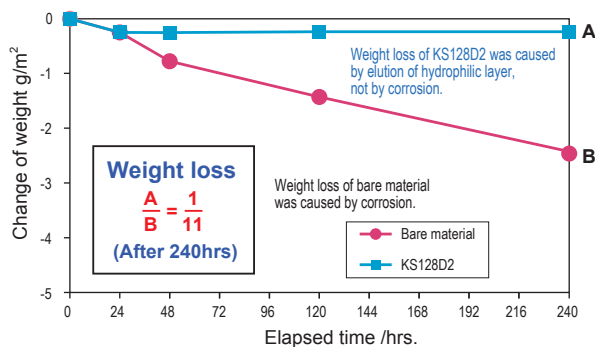

<Test conditions>

JIS Z2371
NaCl concentration : 50g/L
pH : 6.5~7.2
temperature : 35°C

Acetic acid salt water spray test

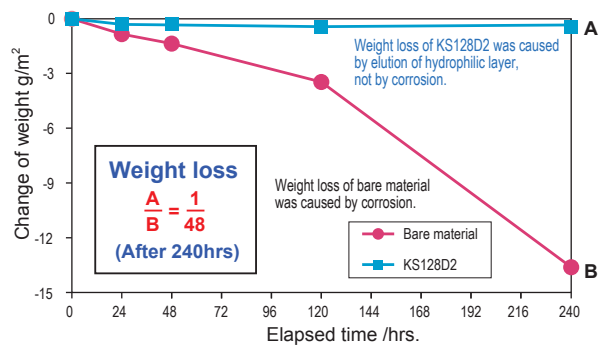

<Test conditions>

JIS Z2371
NaCl concentration : 50g/L
pH : 3.1~3.3 (adjusted with acetic acid)
temperature : 35°C

Appearance comparison before and after acetic acid salt water spray test

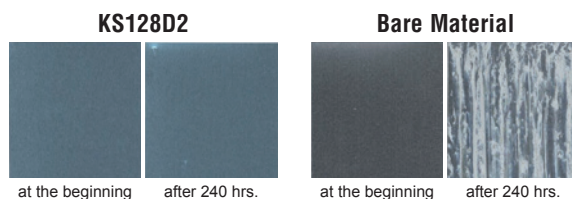

For outside sheet metals, Cation electrodeposition coating is used for undercoat plus polyester powder coating or acrylic baked coating for top coat and corrosion protection is applied for heat exchanger, welded parts, fan guard, fin guard and other major parts.

Preventing corrosion by salt damage or sulfurous acid gas has made service life of this series longer while its exterior appearance has been greatly improved.

Durability of this series for anticorrosion is about two times that of standard outdoor units under the same conditions.

Additional treatment from the standard series

		Micro	KXZ
Exterior panel		undercoat: Cation electrodeposition coating topcoat: polyester powder coating or acrylic baked coating	undercoat: Cation electrodeposition coating topcoat: acrylic baked coating
Base plate		undercoat: Cation electrodeposition coating topcoat: polyester powder coating or acrylic baked coating	undercoat: Cation electrodeposition coating topcoat: acrylic baked coating
Drain pan		_____	undercoat: Cation electrodeposition coating topcoat: acrylic baked coating
Fan motor		application of anticorrosion compound	application of anticorrosion compound
Fan motor base		4~6HP _____	application of anticorrosion compound
		8~12HP application of anticorrosion compound	
Heat exchanger	Fin	Precoated Aluminum Blue Fins in high anticorrosion specification	Precoated Aluminum Blue Fins in high anticorrosion specification
	pipe	application of anticorrosion compound	application of anticorrosion compound
	Side plate	application of anticorrosion compound	application of anticorrosion compound
Compressor		application of anticorrosion compound	application of anticorrosion compound
Accumulator		application of anticorrosion compound	application of anticorrosion compound
Receiver		application of anticorrosion compound	application of anticorrosion compound
Control box		4~6HP _____	galvanized steel sheet + undercoat: Cation electrodeposition coating + topcoat: acrylic baked finish
		8~12HP application of anticorrosion compound	
Baffle plate		4~6HP _____	_____
		8~12HP application of anticorrosion compound	
Service valve bracket		4~6HP _____	galvanized steel sheet + undercoat: Cation electrodeposition coating + topcoat: acrylic baking finish
		8~12HP application of anticorrosion compound	
Screw for exterior panel		zinc coating + chromate treatment + fluorine coating	zinc coating + chromate treatment + fluorine coating
Screw tap for inside of exterior panel		zinc coating + chromate treatment + fluorine coating	zinc coating + chromate treatment + fluorine coating

Corrosion protection treatment complies with regulation of The Japan Refrigeration and Air Conditioning Industry Association (JRA9002)

Caution

Even if the outdoor unit is protected with the anti-salt damage treatment, it cannot be perfectly free from rusting.

The following points should be kept in mind during installation and maintenance of the outdoor units.

Installation

- (1) When installing the outdoor unit close to the coastal area, provide a windbreak to protect it from direct sea breeze and salt water splash.
- (2) Select a well-drained place to install.
- (3) If any scratch or damages occurred on the outdoor unit during installation, repair it carefully.

Maintenance

- (1) Clean salt grains on the outdoor unit with fresh water periodically.
- (2) Apply rust preventive at regular intervals for maintenance depending on the conditions at the installation place (consulting with the withstanding capacity).
- (3) Confirm reset of screw tap after maintenance, if missing it may cause corrosion occurred from the hole of screw tap.
- (4) During prolonged non operation periods, protect the unit with covering.



Dimensions

All measurements in mm.

FDCS112KXEN6, FDCS112KXES6, FDCS140KXEN6, FDCS140KXES6, FDCS155KXEN6, FDCS155KXES6

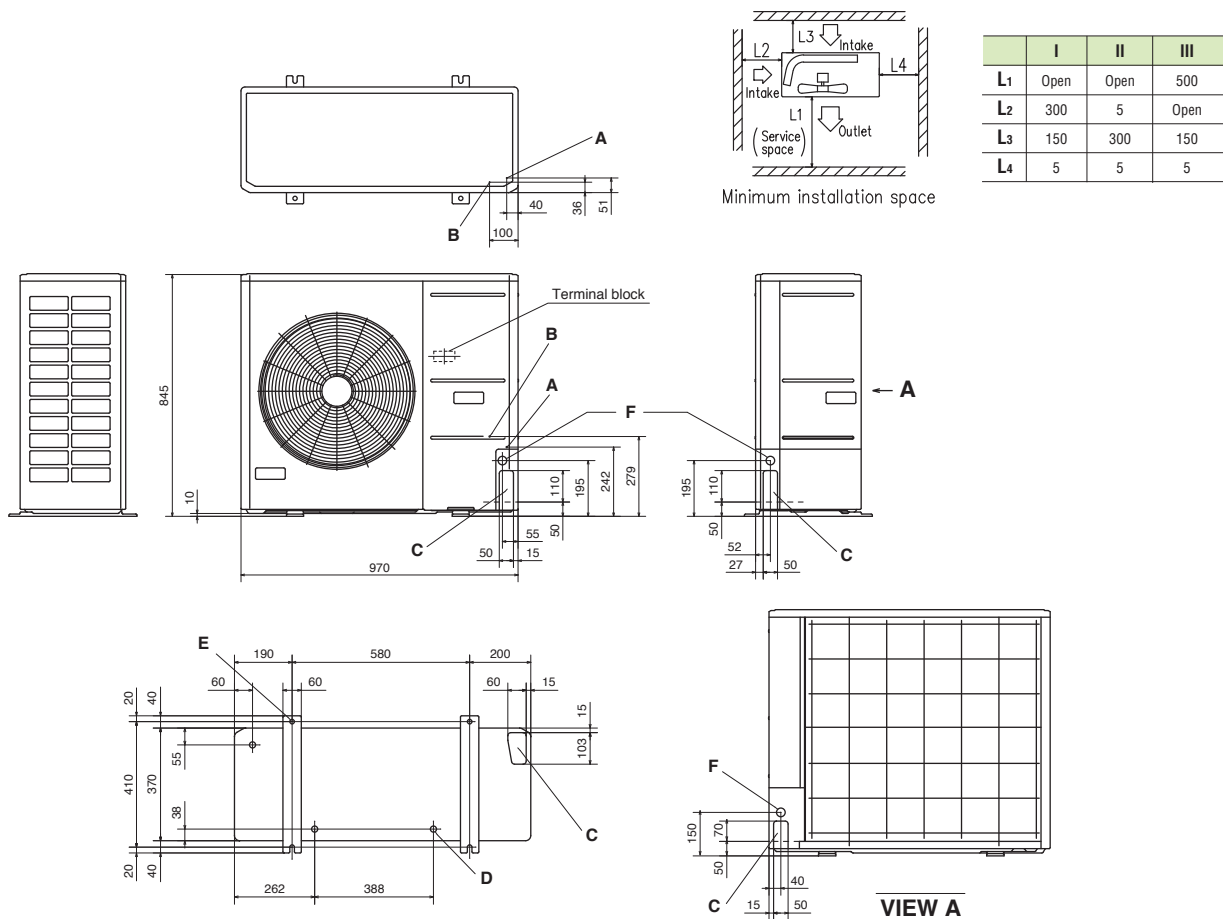

Mark	Content	
A	Service valve connection (gas side)	ø15.88 (5/8") (Flare)
B	Service valve connection (liquid side)	ø9.52 (3/8") (Flare)
C	Pipe/cable draw-out hole	4 places
D	Drain discharge hole	ø20 x 3 places
E	Anchor bolt hole	M10 x 4 places
F	Cable draw-out hole	ø30 x 3 places

Notes:

- (1) It must not be surrounded by walls on the four sides.
- (2) The unit must be fixed with anchor bolts. An anchor bolt must not protrude more than 15mm.
- (3) Where the unit is subject to strong winds, lay it in such a direction that the blower outlet faces perpendicularly to the dominant wind direction.
- (4) Leave 1m or more space above the unit.
- (5) A wall in front of the blower outlet must not exceed the units height.
- (6) The model name label is attached on the lower right corner of the front panel.

Refrigerant piping

Outdoor unit (HP)		4	5	6
Gas pipe	Furthest indoor unit =<70m	ø15.88		
Liquid pipe		ø9.52		

Branch pipes

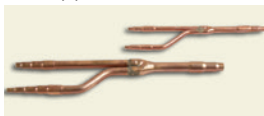

DIS-22-1G
DIS-180-1G

Header pipe



HEAD4-22-1G
HEAD6-180-1G

Dimensions

All measurements in mm.

FDCS224KXE6G, FDCS280KXE6G, FDCS335KXE6G

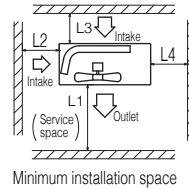
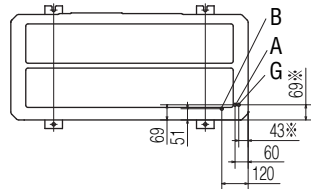

	I	II	II
L1	Open	Open	1500
L2	300	5	Open
L3	300	300	300
L4	5	5	5

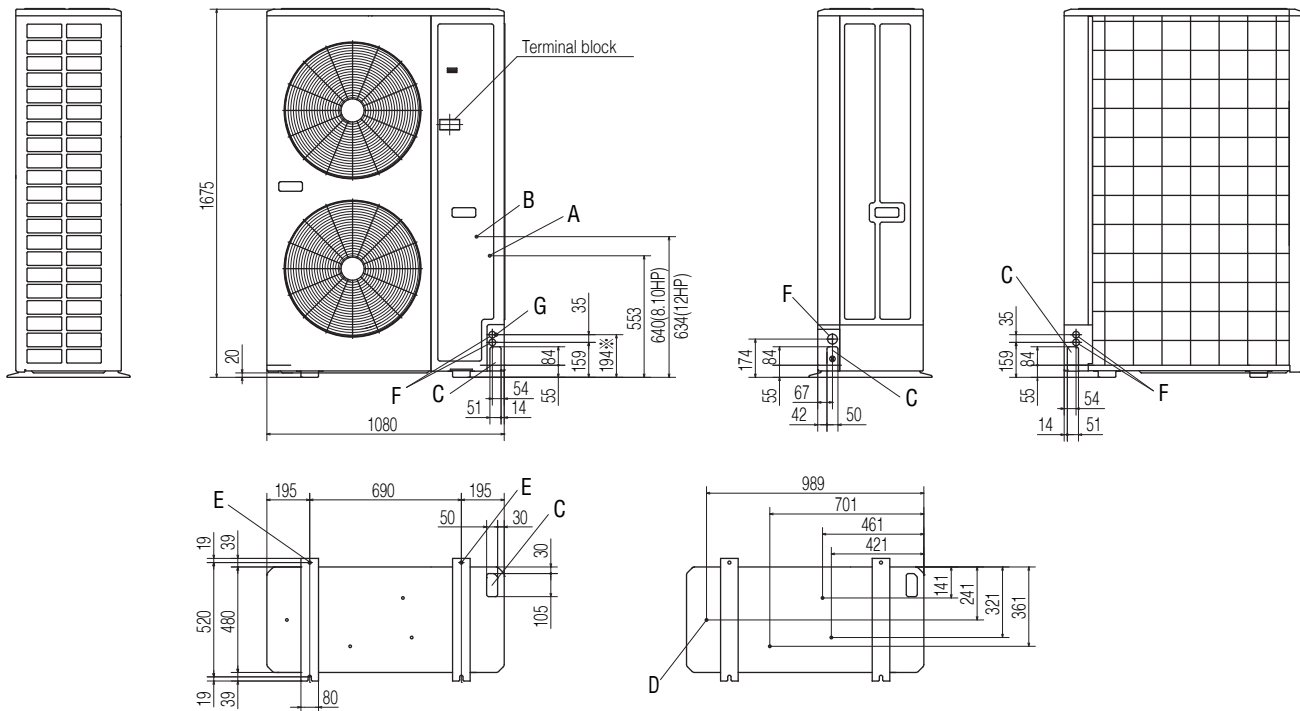

Mark	Content	224	280	335
A	Service valve connection of the attached connecting pipe (gas side)	ø19.05 (3/4") (Flare)	ø19.05 (3/4") (Flare)	ø19.05 (3/4") (Flare)
B	Service valve connection (liquid side)	ø9.52 (3/8") (Flare)	ø9.52 (3/8") (Flare)	ø12.7 (1/2") (Flare)
C	Pipe/cable draw-out hole	4places	4places	4places
D	Drain discharge hole	ø20 × 4places	ø20 × 4places	ø20 × 4places
E	Anchor bolt hole	M10 × 4places	M10 × 4places	M10 × 4places
F	Cable draw-out hole	ø30 × 2places (front) ø45 (side) ø30 × 2places (back)	ø30 × 2places (front) ø45 (side) ø30 × 2places (back)	ø30 × 2places (front) ø45 (side) ø30 × 2places (back)
G	Connecting position of the local pipe. (gas side)	ø19.05 (3/4")(Brazing)	ø22.22 (7/8")(Brazing)	ø25.4 (1")(Brazing)

Notes:

- (1) It must not be surrounded by walls on the four sides.
- (2) The unit must be fixed with anchor bolts. An anchor bolt must not protrude more than 15mm.
- (3) Where the unit is subject to strong winds, the blower outlet should face perpendicularly to the dominant wind direction.
- (4) Leave a 1m or more space above the unit.
- (5) A wall in front of the blower outlet must not exceed the unit's height.
- (6) The model name label is attached on the lower right corner of the front.
- (7) Connect the Service valve with local pipe by using the pipe of the attachment.(Gas side only)
- (8) Mark ※ shows the connecting position of the local pipe.(Gas side only)

Refrigerant piping

Outdoor unit (HP)		8	10	12
Gas pipe	Furthest indoor unit =<90m	ø19.05	ø22.22	ø25.4(ø22.22)
Liquid pipe		ø9.52		ø12.7
Gas pipe	90m	ø22.22	ø25.4(ø22.22)	
Liquid pipe	=<Furthest indoor unit	ø12.7		

Branch pipes

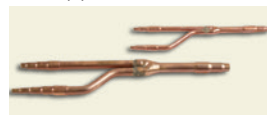

DIS-22-1G
DIS-180-1G



DIS-371-1G

Header pipe



HEAD4-22-1G
HEAD6-180-1G
HEAD8-371-2



Water cooled series

8~36HP (22.4~100.0kW)

Model No.	Nominal Cooling Capacity	Model No.	Nominal Cooling Capacity
FDC224KXZWE1	22.4kW	FDC730KXZWE1(FDC224×2+FDC280)	73.0kW
FDC280KXZWE1	28.0kW	FDC775KXZWE1(FDC224+FDC280×2)	77.5kW
FDC335KXZWE1	33.5kW	FDC850KXZWE1(FDC280×3)	85.0kW
FDC450KXZWE1(FDC224×2)	45.0kW	FDC900KXZWE1(FDC280×2+FDC335)	90.0kW
FDC500KXZWE1(FDC224+FDC280)	50.0kW	FDC950KXZWE1(FDC280+FDC335×2)	95.0kW
FDC560KXZWE1(FDC280×2)	56.0kW	FDC1000KXZWE1(FDC335×3)	100.0kW
FDC615KXZWE1(FDC280+FDC335)	61.5kW		
FDC670KXZWE1(FDC335×2)	67.0kW		

Features

1. High efficiency (EER/COP)

- Energy saving → Reduction of operation cost!

2. Compact design

- Easy transportation and installation
- Elevator carrying

3. BMS (Building Management System)

- Can use the same BMS as air-cooled KX
- Available to large-scale and fine control

4. Serviceability & Maintenance

- Service and maintenance of main parts can be done from the front side only
- Useful service tools (Mente-PC, SL-Checker etc.)

Applicable to

1. High-rise Building

- 50m <FDC> , -100m <FDCH>
- 100m or higher in height <FDCW>

2. Glass-exterior facade Building

- Possible to hide KXZW units and to keep fine sight



Specifications

Item	Model	FDC224KXZWE1	FDC280KXZWE1	FDC335KXZWE1	FDC450KXZWE1	FDC500KXZWE1	FDC560KXZWE1	FDC615KXZWE1	FDC670KXZWE1
Combination (FDC)		-	-	-	224KXZWE1	224KXZWE1	280KXZWE1	280KXZWE1	335KXZWE1
		-	-	-	224KXZWE1	280KXZWE1	280KXZWE1	335KXZWE1	335KXZWE1
Nominal horse power		8HP	10HP	12HP	16HP	18HP	20HP	22HP	24HP
Power source		3 Phase 380-415V, 50Hz							
Nominal capacity	Cooling	22.4	28.0	33.5	45.0	50.0	56.0	61.5	67.0
	Heating	25.0	31.5	37.5	50.0	56.0	63.0	69.0	75.0
Power consumption	Cooling	4.23	5.75	8.13	8.49	9.83	11.5	13.7	16.3
	Heating	4.24	5.10	6.30	8.47	9.27	10.2	11.4	12.6
EER	Cooling	5.3	4.9	4.1	5.3	5.1	4.9	4.5	4.1
COP	Heating	5.9	6.2	6.0	5.9	6.0	6.2	6.1	6.0
Exterior dimensions	HxWxD	mm 1100x780x550				mm (1100x780x550)x2			
Sound pressure level	dB(A)	48	50	52	50	52	53	54	55
Net weight	kg	185				185x2			

Item	Model	FDC730KXZWE1	FDC775KXZWE1	FDC850KXZWE1	FDC900KXZWE1	FDC950KXZWE1	FDC1000KXZWE1
Combination (FDC)		224KXZWE1	224KXZWE1	280KXZWE1	280KXZWE1	280KXZWE1	335KXZWE1
		224KXZWE1	280KXZWE1	280KXZWE1	280KXZWE1	335KXZWE1	335KXZWE1
		280KXZWE1	280KXZWE1	280KXZWE1	335KXZWE1	335KXZWE1	335KXZWE1
Nominal horse power		26HP	28HP	30HP	32HP	34HP	36HP
Power source		3 Phase 380-415V, 50Hz					
Nominal capacity	Cooling	73.0	77.5	85.0	90.0	95.0	100
	Heating	82.5	90.0	95.0	100	106	112
Power consumption	Cooling	14.2	15.5	17.5	19.5	21.7	24.3
	Heating	13.8	14.8	15.4	16.4	17.6	18.8
EER	Cooling	5.1	5.0	4.9	4.6	4.4	4.1
COP	Heating	6.0	6.1	6.2	6.1	6.0	6.0
Exterior dimensions	HxWxD	mm (1100x780x550)x3					
Sound pressure level	dB(A)	54	54	55	56	56	57
Net weight	kg	185x3					

The data is based on the rating condition:

Cooling: Indoor temp. of 27 °C DB, 19 °C WB, and heat source unit inlet water temp. of 30 °C, water flow rate 96 L/min
 Heating: Indoor temp. of 20 °C DB, 15 °C WB, and heat source unit inlet water temp. of 20 °C, water flow rate 96 L/min

Heat source units on every floor
- New building projects -

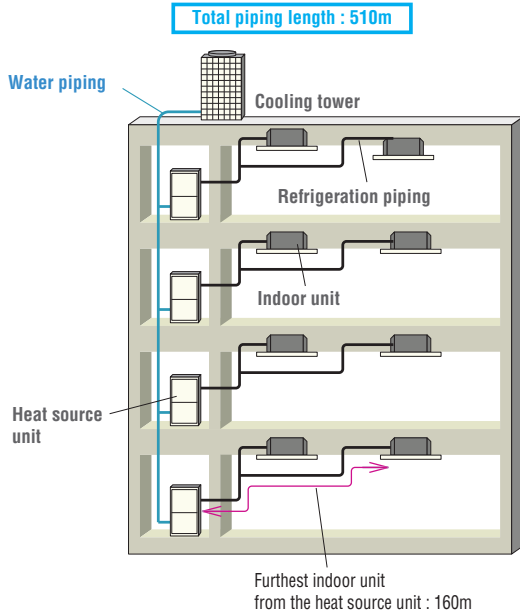

Heat source units in the machine room
- Renovation projects -

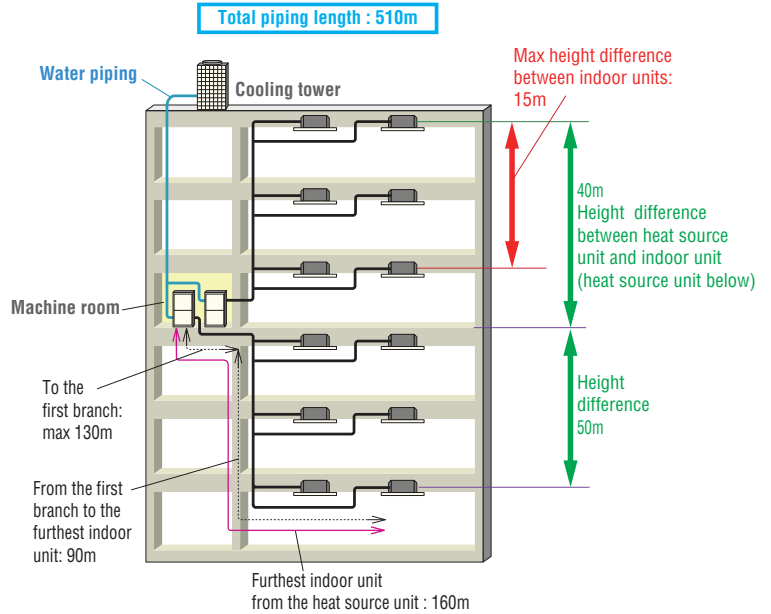

Dimensions

All measurements in mm.

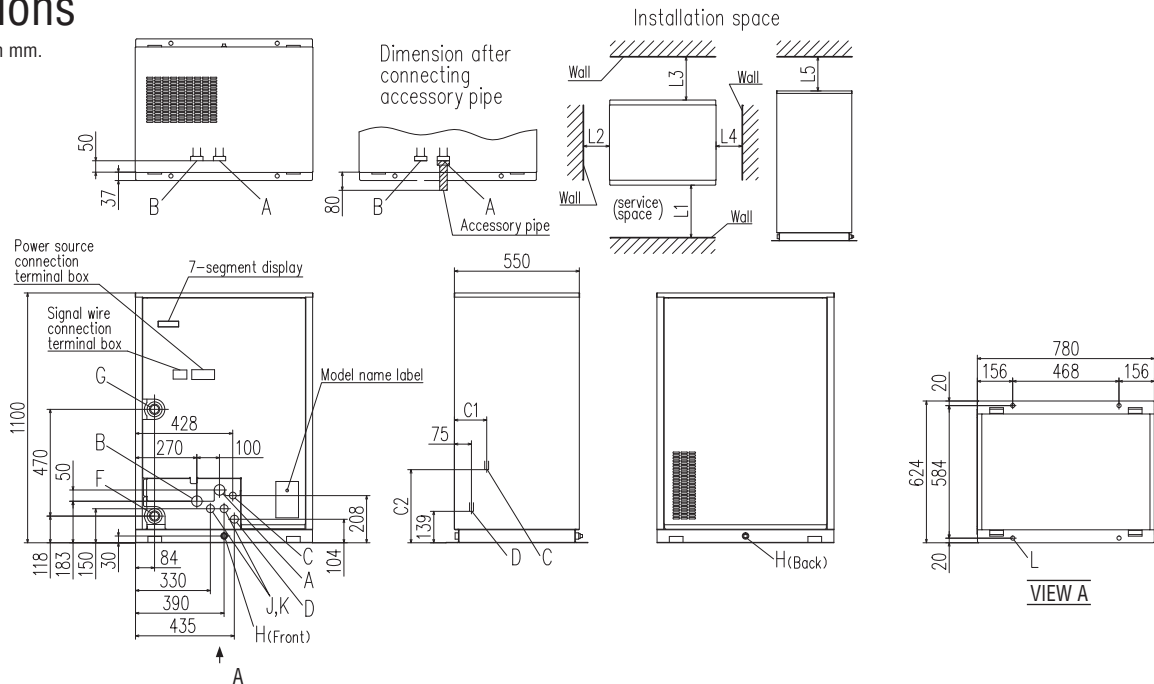

Mark	Content	
A	High/low gas line	Refer to piping size
B	-	Not to use.
C	Liquid line	Refer to piping size
D	Oil equalization line	
F	Water inlet	R1 1/4
G	Water outlet	R1 1/4
H	Drain outlet	Rp 1/2, 2places
J	Power source intake	ø35
K	Signal wiring intake	ø35
L	Anchor bolt hole	ø18, 4places

Dimension	FDC-KXZWE1	
	224,280	335
C1	142	139
C2	322	316
	Installation example 1	
Dimension		
L1	600 or more	
L2	20 or more	
L3	500 or more	
L4	20 or more	
L5	300 or more	

Piping size

	FDC224KXZWE1	FDC280KXZWE1	FDC335KXZWE1	Connection method
High/low gas line	ø19.05	ø22.22	ø25.4	Flange
Liquid line	ø9.52	ø9.52	ø12.7	Flare
Oil equalization line	ø9.52	ø9.52	ø9.52	



High Head series (100m) **cooling only**

14~48HP (40.0~136.0kW)

Model No. Nominal Cooling Capacity

FDCH335CKXE6G-K*	33.5 kW(380V)
FDCH400CKXE6G	40.0 kW(380V)
FDCH450CKXE6G	45.0 kW(380V)
FDCH504CKXE6G	50.4 kW(380V)
FDCH560CKXE6G	56.0 kW(380V)
FDCH560CKXE6G-K*	56.0 kW(380V)
FDCH615CKXE6G	61.5 kW(380V)
FDCH680CKXE6G	68.0 kW(380V)

*FDCH335CKXE6G-K & FDCH560CKXE6G-K are only used for combining with other models.

- Maximum allowable height difference between the outdoor and the indoor unit located at the lowest height position has been increased from 50m to 100m.

(When the outdoor unit is located at higher position than the indoor unit)

- Non-CE Marking models.

Model No. Nominal Cooling Capacity

FDCH735CKXE6G (FDCH335-K+FDCH400)	73.5 kW(380V)
FDCH800CKXE6G (FDCH400x2)	80.0 kW(380V)
FDCH850CKXE6G (FDCH400+FDCH450)	85.0 kW(380V)
FDCH900CKXE6G (FDCH450x2)	90.0 kW(380V)
FDCH960CKXE6G (FDCH450+FDCH504)	96.0 kW(380V)
FDCH1010CKXE6G (FDCH504x2)	101.0 kW(380V)
FDCH1065CKXE6G (FDCH504+FDCH560)	106.5 kW(380V)
FDCH1130CKXE6G (FDCH560x2)	113.0 kW(380V)
FDCH1180CKXE6G (FDCH560-K+FDCH615)	118.0 kW(380V)
FDCH1235CKXE6G (FDCH615x2)	123.5 kW(380V)
FDCH1300CKXE6G (FDCH615+FDCH680)	130.0 kW(380V)
FDCH1360CKXE6G (FDCH680x2)	136.0 kW(380V)



**FDCH335CKXE6G-K
FDCH400CKXE6G
FDCH450CKXE6G**



FDCH504~680CKXE6G

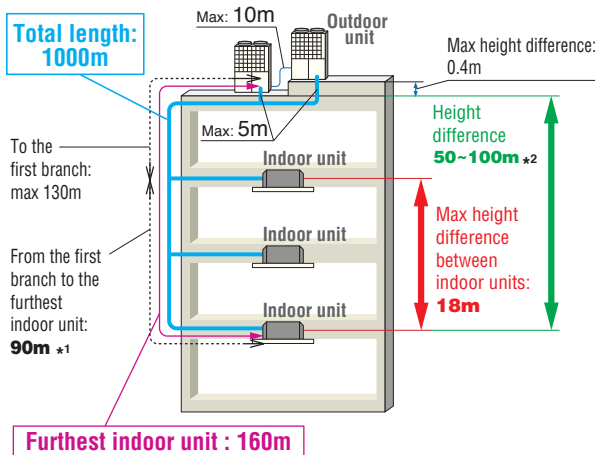

Range of operation

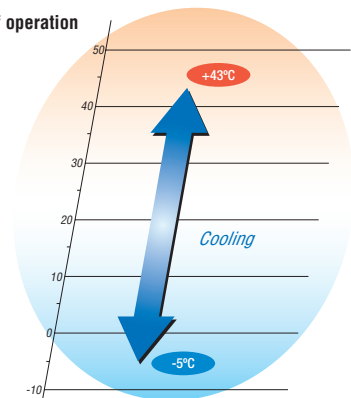

*1 The difference between the longest and shortest indoor unit piping from the first branch must be within 40m.

*2 In case of less than 50m, the High Head models can not be applied.
In case Indoor unit is higher than outdoor unit, the High Head models can not be applied.

Specifications

Item	Model	FDCH400CKXE6G	FDCH450CKXE6G	FDCH504CKXE6G	FDCH560CKXE6G	FDCH615CKXE6G	FDCH680CKXE6G		
Nominal horse power		14HP	16HP	18HP	20HP	22HP	24HP		
Power source		3 Phase 380V, 60Hz							
Starting current	A	8							
Max current	A	47							
Nominal capacity	Cooling	kW	40.0	45.0	50.4	56.0	61.5	68.0	
Electrical characteristics	Power consumption	Cooling	kW	11.27	12.97	14.73	16.79	20.37	24.98
Exterior dimensions	HxWxD	mm	1690x1350x720			2048x1350x720			
Net weight		kg	326		358		377		
Sound pressure level	Cooling	dB(A)	59.5	62.5	61.5	63.0	64.5	65.0	
Refrigerant	Type/GWP		R410A/2088						
	Charge	kg/TCO ₂ Eq	11.5/24.012						
Refrigerant piping size	Liquid line	mm(in)	ø12.7(1/2")			ø15.88(5/8")			
	Gas line	mm(in)	ø25.4(1") [ø28.58(1 1/8")]		ø28.58(1 1/8")				
Capacity connection		%	50-200			50-160			
Number of connectable indoor units			36	40	36	40	44	49	

Item	Model	FDCH735CKXE6G	FDCH800CKXE6G	FDCH850CKXE6G	FDCH900CKXE6G		
Combination (FDCH)		335CKXE6G-K	400CKXE6G	400CKXE6G	450CKXE6G		
		400CKXE6G	400CKXE6G	450CKXE6G	450CKXE6G		
Nominal horse power		26HP	28HP	30HP	32HP		
Power source		3 Phase 380V, 60Hz					
Starting current	A	16					
Max current	A	94					
Nominal capacity	Cooling	kW	73.5	80.0	85.0	90.0	
Electrical characteristics	Power consumption	Cooling	kW	20.21	22.54	24.24	25.94
Exterior dimensions	HxWxD	mm	1690x2700x720				
Net weight		kg	326x2				
Refrigerant charge	R410A	kg	11.5x2				
Refrigerant piping size	Liquid line	mm(in)	ø19.05(3/4")				
	Gas line	mm(in)	ø31.8(1 1/4") [ø34.92(1 3/8")]				
Capacity connection		%	50-160				
Number of connectable indoor units			53	58	61	65	

Item	Model	FDCH960CKXE6G	FDCH1010CKXE6G	FDCH1065CKXE6G	FDCH1130CKXE6G		
Combination (FDCH)		450CKXE6G	504CKXE6G	504CKXE6G	560CKXE6G		
		504CKXE6G	504CKXE6G	560CKXE6G	560CKXE6G		
Nominal horse power		34HP	36HP	38HP	40HP		
Power source		3 Phase 380V, 60Hz					
Starting current	A	16					
Max current	A	94					
Nominal capacity	Cooling	kW	96.0	101.0	106.5	113.0	
Electrical characteristics	Power consumption	Cooling	kW	27.70	29.46	31.52	33.58
Exterior dimensions	HxWxD	mm	2048x2700x720				
Net weight		kg	326+358		358x2		
Refrigerant charge	R410A	kg	11.5x2				
Refrigerant piping size	Liquid line	mm(in)	ø19.05(3/4")			ø22.22(7/8")	
	Gas line	mm(in)	ø31.8(1 1/4") [ø34.92(1 3/8")]			ø38.1(1 1/2")	
Capacity connection		%	50-160		50-130		
Number of connectable indoor units			69	59	62	66	

Item	Model	FDCH1180CKXE6G	FDCH1235CKXE6G	FDCH1300CKXE6G	FDCH1360CKXE6G		
Combination (FDCH)		560CKXE6G-K	615CKXE6G	615CKXE6G	680CKXE6G		
		615CKXE6G	615CKXE6G	680CKXE6G	680CKXE6G		
Nominal horse power		42HP	44HP	46HP	48HP		
Power source		3 Phase 380V, 60Hz					
Starting current	A	16					
Max current	A	94					
Nominal capacity	Cooling	kW	118.0	123.5	130.0	136.0	
Electrical characteristics	Power consumption	Cooling	kW	37.16	40.74	45.35	49.96
Exterior dimensions	HxWxD	mm	2048x2700x720				
Net weight		kg	377x2				
Refrigerant charge	R410A	kg	11.5x2				
Refrigerant piping size	Liquid line	mm(in)	ø22.22(7/8")				
	Gas line	mm(in)	ø38.1(1 1/2")				
Capacity connection		%	50-130				
Number of connectable indoor units			69	72	76	80	

- The data are measured under the following conditions (ISO-T1). Cooling: Indoor temp. of 27°CDB, 19°CWB, and outdoor temp. of 35°CDB. Heating: Indoor temp. of 20°CDB, and outdoor temp. of 7°CDB, 6°CWB. Piping length is 7.5m.
- Sound pressure level indicates the value in an anechoic chamber. During operation these values are somewhat higher due to ambient conditions.
- 'tonne(s) of CO₂ equivalent' means a quantity of greenhouse gases- expressed as the product of the weight of the greenhouse gases in metric tonnes and of their global warming potential.
- [] : Pipe sizes applicable to European installations are shown in parentheses.

Dimensions

All measurements in mm.

FDCH335CKXE6G-K, 400CKXE6G, 450CKXE6G

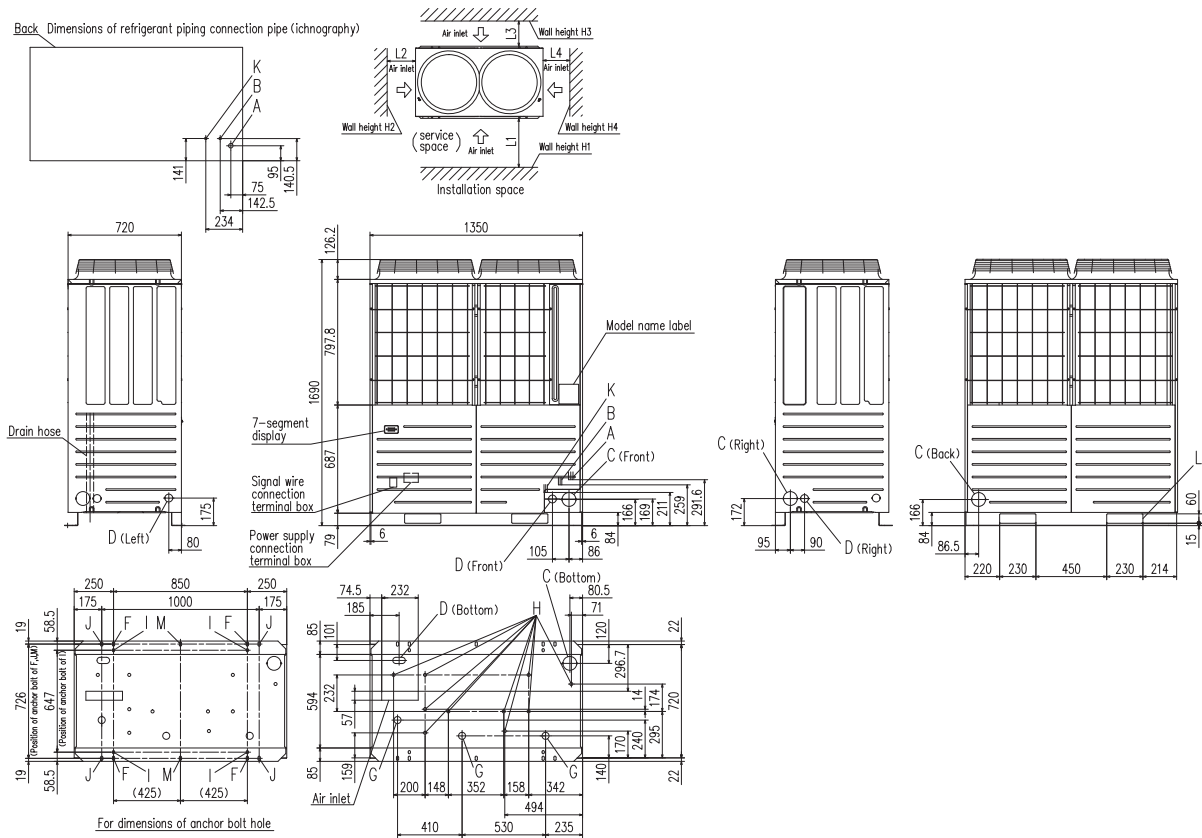

Mark	Content	335-K	400	450
A	Refrigerant gas piping connection pipe	ø25.4(Brazing)		ø28.58(Brazing)
B	Refrigerant liquid piping connection pipe	ø12.7(Flare)		
C	Refrigerant piping exit hole	ø88(or ø100)		
D	Power supply entry hole	ø50 (Right · Left · Front), Long hole 40 x 80 (Bottom)		
F	Anchor bolt hole	M10, 4 pcs		
G	Drain waste water hose hole	ø45, 3 pcs		
H	Drain hole	ø20, 10 pcs		
K	Refrigerant oil equalization piping connection pipe	ø9.52(Flare)		
L	Carrying in or hole for hanging	230 x 60		

Installation example		
Dimensions	1	2
L ₁	500	Open
L ₂	10	10
L ₃	100	100
L ₄	10	Open
H ₁	1500	Open
H ₂	No limit	No limit
H ₃	1000	No limit
H ₄	No limit	Open

Notes:

- (1) The unit must be fixed with anchor bolts.
- (2) Leave a 2m or larger space above the unit.
- (3) The unit name plate is attached on the lower right corner of the front panel.
- (4) The ports for refrigerant pipe and power cable penetrations are covered with half-blanks. Please cut off a half-blank with nippers in using these ports.
- (5) Use a ø88 port for refrigerant pipe connection.
- (6) Anchor holes marked "L J" (four holes for M10) are for a renewal installation.
- (7) The oil-equalising pipe K should be used when outdoor units are used in combination. (For 14,16Hp only)

When more than one unit is installed

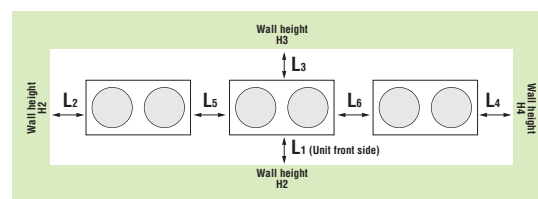

Installation example		
Dimensions	1	2
L ₁	500	Open
L ₂	10	200
L ₃	100	300
L ₄	10	Open
L ₅	0	400
L ₆	0	400
H ₁	1500	No limit
H ₂	No limit	No limit
H ₃	1000	No limit
H ₄	No limit	No limit

Dimensions

All measurements in mm.

FDCH504CKXE6G, 560CKXE6G, 560CKXE6G-K, 615CKXE6G, 680CKXE6G

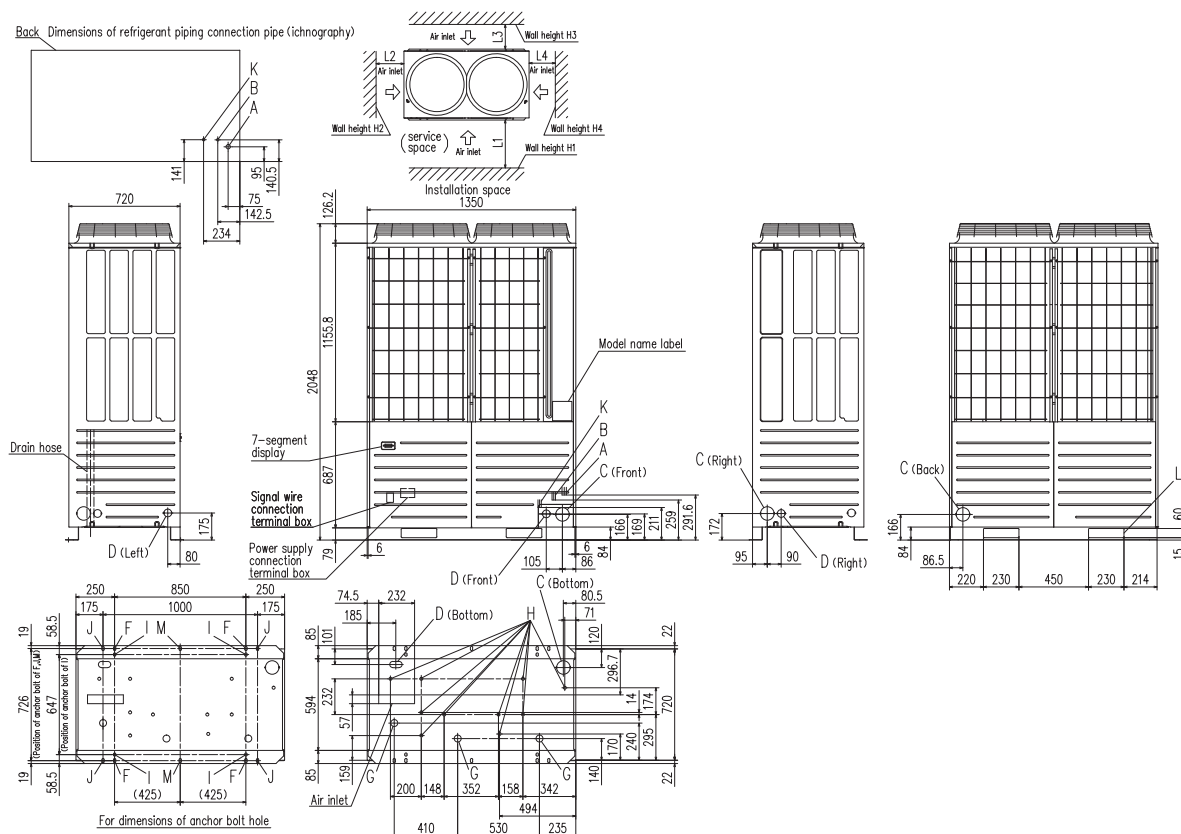

Mark	Content	
A	Refrigerant gas piping connection pipe	ø28.58(Brazing)
B	Refrigerant liquid piping connection pipe	ø12.7(Flare)
C	Refrigerant piping exit hole	ø88(or ø100)
D	Power supply entry hole	ø50 (Right · Left · Front), Long hole 40 x 80 (Bottom)
F	Anchor bolt hole	M10, 4 pcs
G	Drain waste water hose hole	ø45, 3 pcs
H	Drain hole	ø20, 10 pcs
K	Refrigerant oil equalization piping connection pipe	ø9.52(Flare)
L	Carrying in or hole for hanging	230 x 60

Installation example		
Dimensions	1	2
L ₁	500	Open
L ₂	10	10
L ₃	100	100
L ₄	10	Open
H ₁	1500	Open
H ₂	No limit	No limit
H ₃	1000	No limit
H ₄	No limit	Open

Notes:

- (1) The unit must be fixed with anchor bolts.
- (2) Leave a 2m or larger space above the unit.
- (3) The unit name plate is attached on the lower right corner of the front panel.
- (4) The ports for refrigerant pipe and power cable penetrations are covered with half-blanks. Please cut off a half-blank with nippers in using these ports.
- (5) Use a ø88 port for refrigerant pipe connection.
- (6) Anchor holes marked "L J" (four holes for M10) are for a renewal installation.
- (7) The oil-equalising pipe K should be used when outdoor units are used in combination.



Refresh series

8, 10HP(22.4kW · 28.0kW)

If replacing a used unit with a new one, these units can reuse existing piping.



Model No.	Nominal Cooling Capacity
FDCR224KXE6	22.4kW
FDCR280KXE6	28.0kW

<Option>

FDCR-KIT-E : Service valve kit

- Applies to a wide range of pipe sizes (R22, R407C, R410A standard size).
- Meets to a short period of renewal installation.
- Savings on replacement expenses such as scrapping waste material or procuring new pipe.
- Possible to replace the existing unit with a new larger capacity unit.
- Possible to replace plural systems with one system.
For example: Existing 5HP × 2units can be replaced with a new 10HP × 1unit.

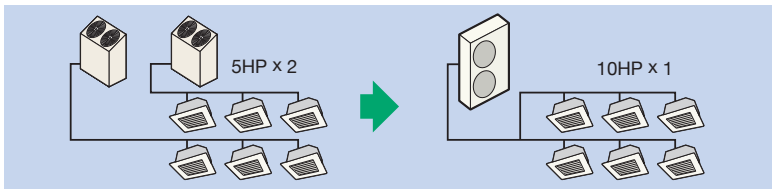

Note: FDUT15KXE6F-E, FDTC15KXE1 and FDK15KXE1 can not be connected to the above systems.

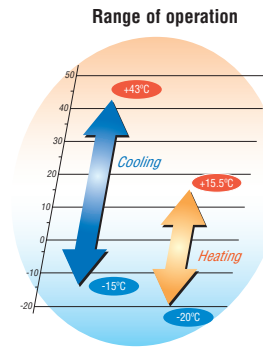
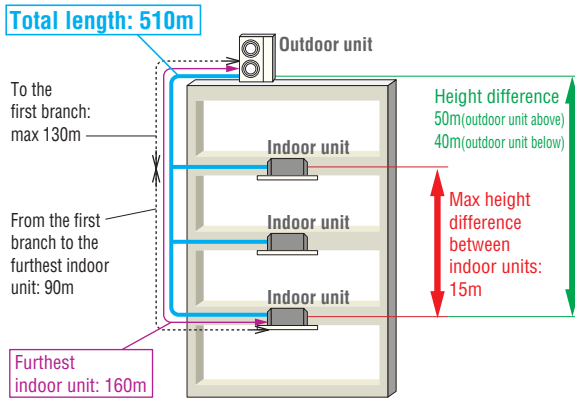

Specifications

Item		Model	FDCR224KXE6	FDCR280KXE6
Nominal horse power			8HP	10HP
Power source			3 Phase 380-415V, 50Hz	
Starting current		A	5	
Max current		A	20	
Nominal capacity	Cooling	kW	22.4	28.0
	Heating	kW	25.0	31.5
Electrical characteristics	Power consumption	Cooling	5.60	8.09
		Heating	6.03	8.21
Exterior dimensions		HxWxD	1675x1080x480	
Net weight		kg	224	
Sound pressure level		Cooling/Heating	58/58	59/60
Refrigerant	Type / GWP		R410A / 2088	
	Charge	kg/TCO ₂ Eq	11.5 / 24.012	
Refrigerant piping size	Liquid line	mm(in)	ø9.52(3/8")~ø15.88(5/8")	
	Gas line	mm(in)	ø19.05(3/4")~ø25.4(1")	
Capacity connection		%	50~130	
Number of connectable indoor units			13	16

1. The data are measured under the following conditions(ISO-T1). Cooling: Indoor temp. of 27°CDB, 19°CWB, and outdoor temp. of 35°CDB. Heating: Indoor temp. of 20°CDB, and outdoor temp. of 7°CDB, 6°CWB.
 2. Sound pressure level indicates the value in an anechoic chamber. During operation these values are somewhat higher due to ambient conditions.
 3. 'tonne(s) of CO₂ equivalent' means a quantity of greenhouse gases- expressed as the product of the weight of the greenhouse gases in metric tonnes and of their global warming potential.

Advanced refresh function

◆ When the existing unit is operable

The existing pipe can be reused by cooling operation only.

Pipe refresh kit and Service valve kit are not required.

1. Implement cooling operation of all indoor units for more than 30 minutes.
2. Implement pump-down after cooling operation.
3. Recover refrigerant and remove the existing outdoor unit and indoor unit.

◆ When the existing unit is not operable

The existing pipe can be reused by washing operation after connecting Refresh outdoor units, Pipe refresh kit and Service valve kit.

Connecting and removing of Refresh outdoor units and Pipe refresh kit is very easy by use of flexible pipe and flanges.

1. Pipe washing operation is implemented by changing dip switch on the outdoor unit PCB.
2. Completing washing is monitored via 7-segment display on the outdoor unit PCB.
3. As washing operation is about 60 minutes, it can meet to a required short period of renewal installation.

7-segment display

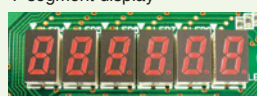

Pipe refresh kit (FDCR-KIT-E)

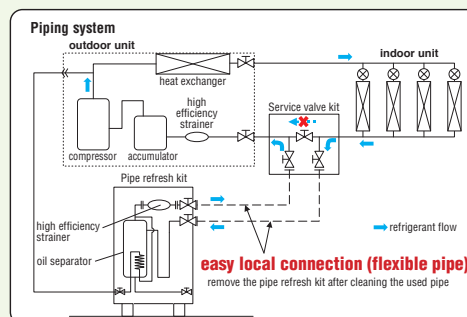

Dimensions

All measurements in mm.

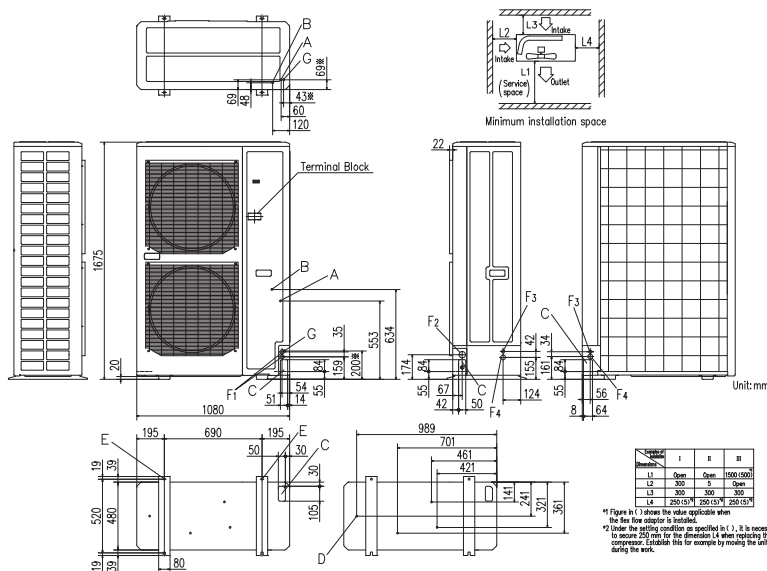

Service valve kit

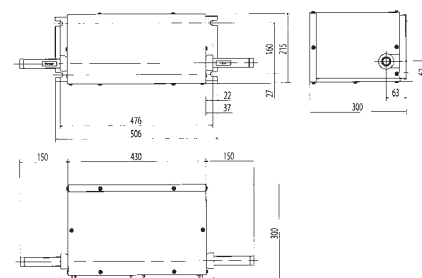

Mark	Content	
A	Service valve connection of the attached connecting pipe (gas side)	ø19.05 (3/4") (Flare)
B	Service valve connection (liquid side)	ø12.7 (1/2) (Flare)
C	Pipe/cable draw-out hole	4places
D	Drain discharge hole	ø20 × 4places
E	Anchor bolt hole	M10 × 4places
F1	Cable draw-out hole	ø30
F2	Cable draw-out hole	ø45
F3	Cable draw-out hole	ø22
F4	Cable draw-out hole	ø34
G	Connecting position of the local pipe. (gas side)	ø25.4 (1") (Brazing)

Notes:

- (1) It must not be surrounded by walls on the four sides.
- (2) The unit must be fixed with anchor bolts. An anchor bolt must not protrude more than 15mm.
- (3) Where the unit is subject to strong winds, lay it in such a direction that the blower outlet faces perpendicularly to the dominant wind direction.
- (4) Leave 1m or more space above the unit.
- (5) A wall in front of the blower outlet must not exceed the units height.
- (6) The model name label is attached on the lower right corner of the front.
- (7) Connect the Service valve with local pipe by using the pipe of the attachment. (Gas side only)
- (8) Mark ※ shows the connecting position of the local pipe. (Gas side only)



Refrigerant piping

Installation of Interconnecting Pipework

KXZ/KX6 equipment is manufactured to the highest standards of quality and reliability. It is imperative that the method of installation and the materials used are also to high standards, to ensure trouble free operation and long term reliability.

The interconnecting pipework must be installed by a competent and trained engineer. Refrigeration quality copper tube must be used, soft copper coils or half-hard straight lengths. The refrigeration quality tube must be soft drawn seamless high grade copper pipe. The copper tube must be selected taking into account the higher operating pressures of R410A refrigerant, and that high pressures will occur throughout the system because of the reverse cycle operation. All pipework material used should be EN12735 European standard.

The supplied branch pipe kits, must be used to make connections to indoor units, and the supplied manifold kits must be used to make connections between outdoor units (where applicable); it is not permitted to use standard fittings such as elbows, tees etc. The branch pipes shall be installed in accordance with the manufacturer's instructions, allowing unrestricted flow of refrigerant, and in accordance with European standard E378.

All brazed joints shall be made with dry nitrogen purge to ensure the prevention of oxidation to the internal surface of the copper pipes.

The ingress of moisture, dirt and any other contaminants to the interior of the copper pipes, and air conditioning units, must be prevented during the installation procedure.

After the installation of pipework, prior to the connection of the outdoor units, and sealing of insulation joints, the pipework must be pressure tested for leakage, using dry nitrogen.

Additional Refrigerant

Only R410A refrigerant shall be used, it must be charged by weight only, using electronic scales. The amount of additional refrigerant must be accurately calculated from the manufacturer's data, based on the length and diameter of each section of the liquid refrigerant pipework of the system.

The products contains fluorinated greenhouse gases covered by Kyoto protocol.

Single outdoor unit piping examples:

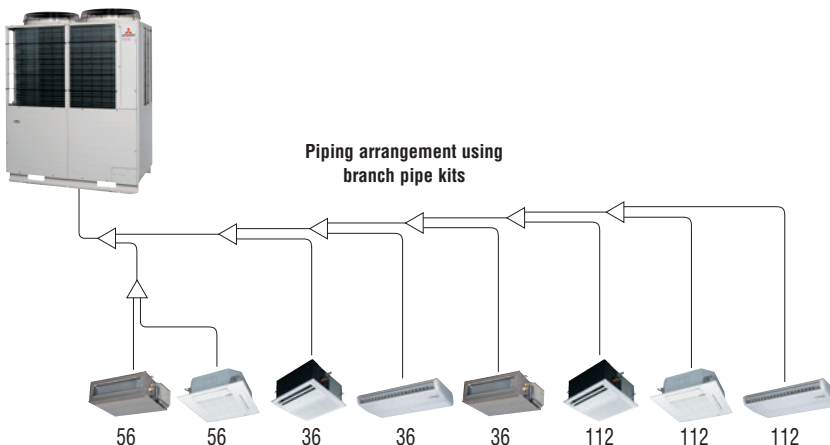
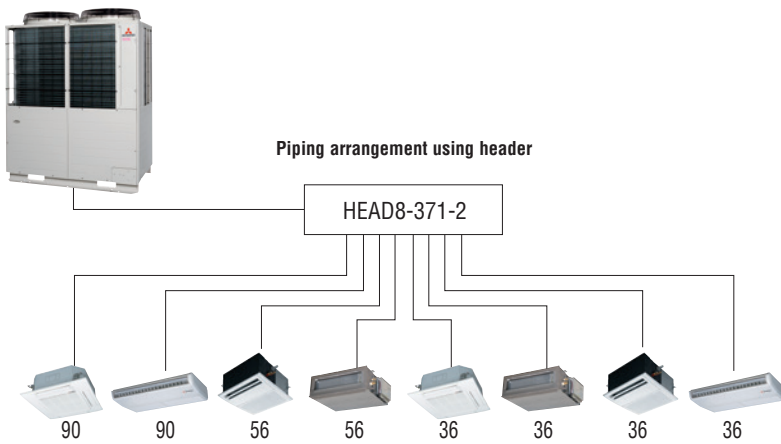

Main (Outdoor unit side branching pipe – Indoor unit side first branching pipe)

If the longest distance (measured between the outdoor unit and the farthest indoor unit) is 90m or longer (actual length), please change the main pipe size according to the table below.

Outdoor unit	Main pipe size (normal)		Pipe size for an actual length of 90m or longer		mm	inch						
	Gas pipe	Liquid pipe	Gas pipe	Liquid pipe								
280	ø22.22 × t 1.0	ø9.52 × t 0.8	ø25.4 (ø22.22) × t 1.0	ø12.7 × t 0.8	ø9.52	3/8"						
335	ø25.4 (ø22.22) × t 1.0	ø12.7 × t 0.8			ø28.58 × t 1.0	ø12.7	1/2"					
400	ø25.4 (ø28.58) × t 1.0		ø31.8 × t 1.1 (ø28.58 × t 1.0)	ø15.88 × t 1.0	ø15.88	5/8"						
450	ø28.58 × t 1.0				ø19.05 × t 1.0	ø38.1 × t 1.35 (ø34.92 × t 1.2)	ø19.05	3/4"				
475			ø31.8 × t 1.1 (ø34.92 × t 1.2)	ø15.88 × t 1.0			ø19.05 × t 1.0	ø22.22	7/8"			
500								ø38.1 × t 1.35 (ø34.92 × t 1.2)	ø19.05 × t 1.0	ø22.22 × t 1.0	ø25.4	1"
560			ø31.8 × t 1.1 (ø34.92 × t 1.2)	ø15.88 × t 1.0			ø19.05 × t 1.0				ø25.4	1"
615	ø38.1 × t 1.35 (ø34.92 × t 1.2)											
670			ø31.8 × t 1.1 (ø34.92 × t 1.2)	ø15.88 × t 1.0			ø19.05 × t 1.0				ø22.22 × t 1.0	ø25.4
735	ø38.1 × t 1.35 (ø34.92 × t 1.2)											
800			ø31.8 × t 1.1 (ø34.92 × t 1.2)	ø15.88 × t 1.0			ø19.05 × t 1.0				ø22.22 × t 1.0	ø25.4
850	ø38.1 × t 1.35 (ø34.92 × t 1.2)	ø19.05 × t 1.0										
900			ø31.8 × t 1.1 (ø34.92 × t 1.2)	ø15.88 × t 1.0			ø19.05 × t 1.0				ø22.22 × t 1.0	ø25.4
950	ø38.1 × t 1.35 (ø34.92 × t 1.2)	ø19.05 × t 1.0			ø22.22 × t 1.0	ø25.4						
1000			ø31.8 × t 1.1 (ø34.92 × t 1.2)	ø15.88 × t 1.0			ø19.05 × t 1.0				ø22.22 × t 1.0	ø25.4
1060	ø38.1 × t 1.35 (ø34.92 × t 1.2)	ø19.05 × t 1.0			ø22.22 × t 1.0	ø25.4		1"				
1120			ø31.8 × t 1.1 (ø34.92 × t 1.2)	ø15.88 × t 1.0			ø19.05 × t 1.0		ø22.22 × t 1.0	ø25.4	1"	
1200	ø38.1 × t 1.35 (ø34.92 × t 1.2)	ø19.05 × t 1.0			ø22.22 × t 1.0	ø25.4		1"				
1250			ø31.8 × t 1.1 (ø34.92 × t 1.2)	ø15.88 × t 1.0			ø19.05 × t 1.0		ø22.22 × t 1.0	ø25.4	1"	
1300	ø38.1 × t 1.35 (ø34.92 × t 1.2)	ø19.05 × t 1.0			ø22.22 × t 1.0	ø25.4		1"				
1350			ø31.8 × t 1.1 (ø34.92 × t 1.2)	ø15.88 × t 1.0			ø19.05 × t 1.0		ø22.22 × t 1.0	ø25.4	1"	
1425	ø38.1 × t 1.35 (ø34.92 × t 1.2)	ø19.05 × t 1.0			ø22.22 × t 1.0	ø25.4		1"				
1450			ø31.8 × t 1.1 (ø34.92 × t 1.2)	ø15.88 × t 1.0			ø19.05 × t 1.0		ø22.22 × t 1.0	ø25.4	1"	
1500	ø38.1 × t 1.35 (ø34.92 × t 1.2)	ø19.05 × t 1.0			ø22.22 × t 1.0	ø25.4		1"				
1560			ø31.8 × t 1.1 (ø34.92 × t 1.2)	ø15.88 × t 1.0			ø19.05 × t 1.0		ø22.22 × t 1.0	ø25.4	1"	
1620	ø38.1 × t 1.35 (ø34.92 × t 1.2)	ø19.05 × t 1.0			ø22.22 × t 1.0	ø25.4		1"				
1680			ø31.8 × t 1.1 (ø34.92 × t 1.2)	ø15.88 × t 1.0			ø19.05 × t 1.0		ø22.22 × t 1.0	ø25.4	1"	

Please use C1220T-1/2H for ø19.05 or larger pipes.
Pipe sizes applicable to European installations are shown in parentheses.

Branch pipes



DIS-22-1G/DIS-180-1G

Header pipe



HEAD6-180-1G

Combination outdoor unit manifold



DIS-371-1G/DIS-540-3



DOS-2A-3

DOS-3A-3

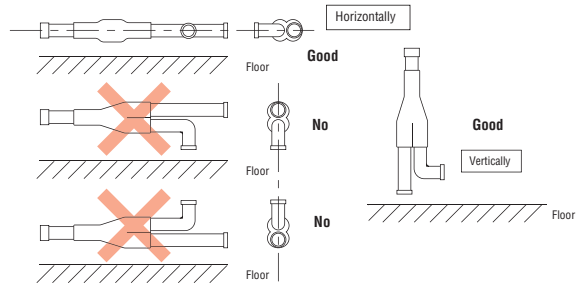

Combination outdoor unit piping examples:

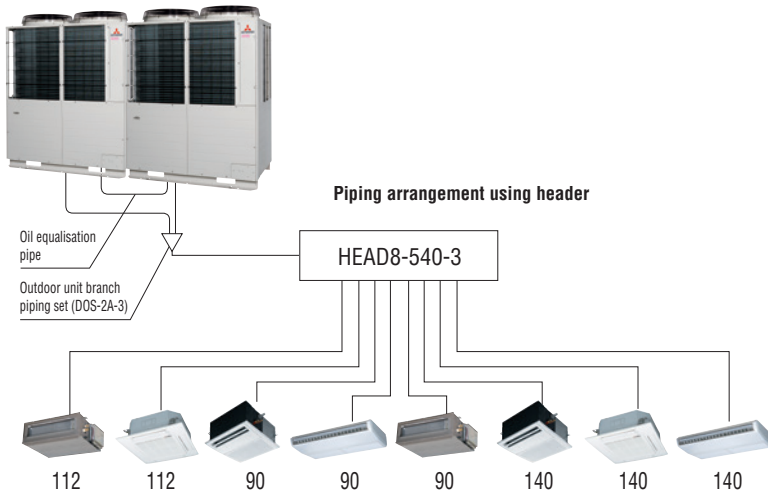
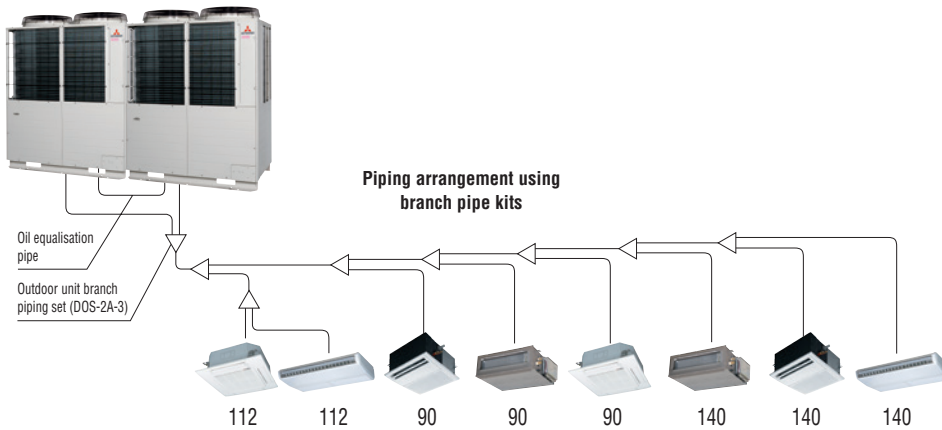

Outdoor unit's branch piping set

Outdoor unit	Branch piping set
For two units (for 615~1120)	DOS-2A-3
For three units (for 1200~1680)	DOS-3A-3

Indoor unit's first branch piping set

Total capacity of indoor units	Branch piping set	Header set	
		Model	Branches
~179	DIS-22-1G	HEAD4-22-1G	Max 4 branches
180~370	DIS-180-1G	HEAD6-180-1G	Max 6 branches
371~539	DIS-371-1G	HEAD8-371-2	Max 8 branches
540~	DIS-540-3	HEAD8-540-3	Max 8 branches

Electrical wiring – power supply

KXZ/KX6 has greatly simplified wiring requirements utilising a 'polarity-free' two wire control loop connecting the indoor units.

Power wiring

Cables can be laid through the front, right, left or bottom of the outdoor unit casing.

Separate power supplies should be used for the outdoor unit (3Phase) and the indoor units (1Phase).

Only control wiring is connected from outdoor to indoor unit.

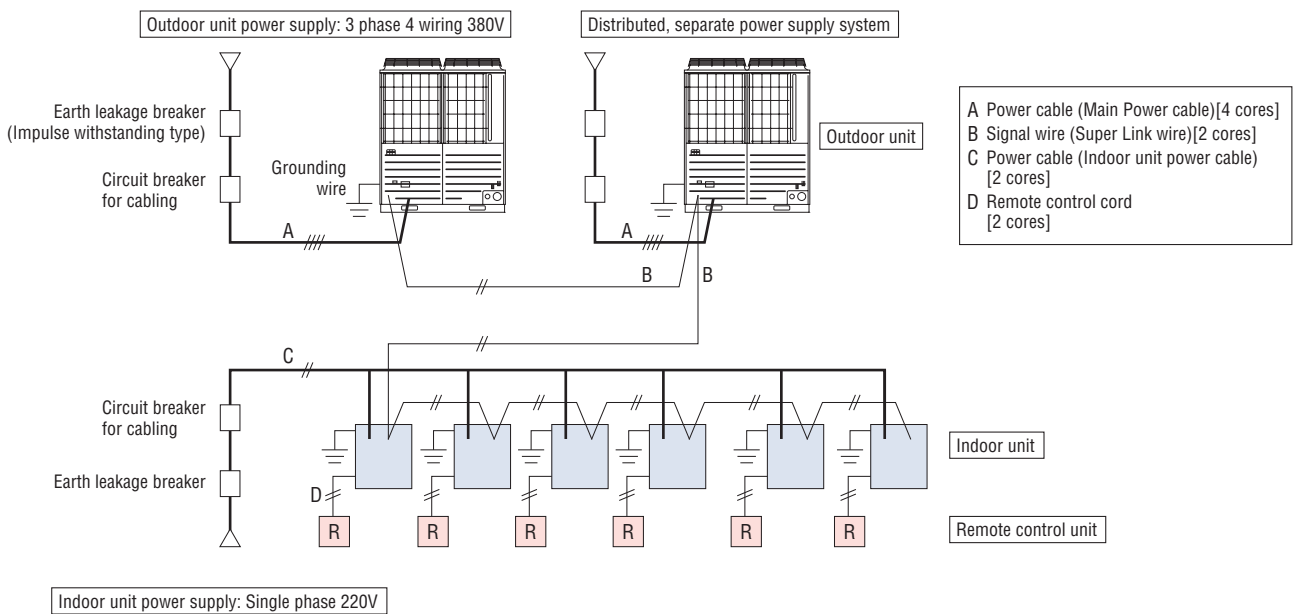

CAUTION

If the earth leakage breaker is exclusively for ground fault protection, then you will need to install a circuit breaker for wiring work.

Electrical wiring – control wiring

1. The control wiring is 5 Volt DC, non-polarised, two wire connection notated as 'A1' and 'B1'. This 'AB' wiring connects outdoor unit to indoor unit and indoor unit to indoor unit.

2. This wiring must be a 2-core shielded cable size 0.75mm² or 1.25mm².

	0.75mm ²	1.25mm ²
~1000m	YES	YES
1000~1500m	YES	NO

3. We recommend both ends of the shield of the cable are connected to ground (earth) at all the indoor units and outdoor units.

4. When multiple outdoor units are used,
 -Connect the signal cable between indoor and outdoor units and the signal cable between outdoor units belonging to the same refrigerant line to A1 and B1.
 -Connect the signal line between outdoor units on different refrigerant lines to A2 and B2.

5. For current specification of 2-core (AB) wiring, please consult your dealer.

(1) When one outdoor unit is used

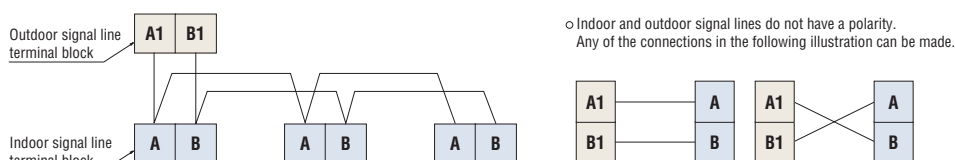

(2) When plural outdoor units are used

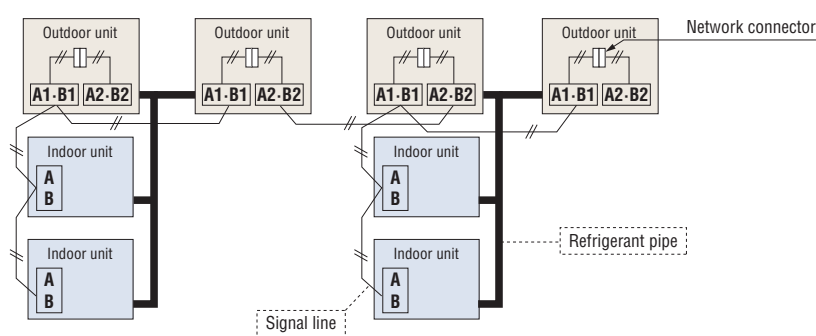

The maximum number of indoor units that can be connected in a system is 128 and it is possible to configure outdoor units and/or indoor units as an outdoor or indoor unit group connected with each other with two wires.

(3) The signal lines can also be connected using the method shown below.

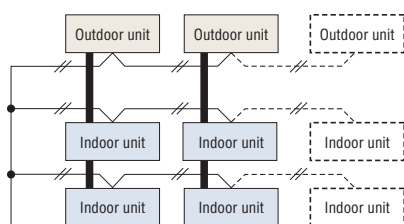

Important Loop wiring prohibited

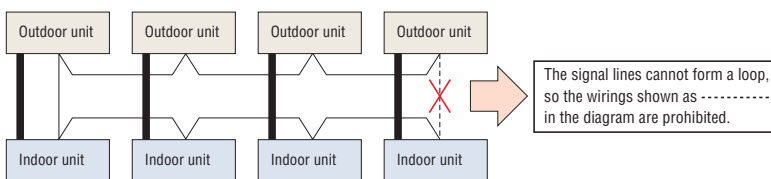

Remote control wiring specifications

For interconnecting wiring between the remote control and indoor units (XY wiring) use 2-core cable size 0.3mm². The maximum length of 2-core cable is 600 metres. Where the 2-core wiring exceeds 100m, use the wire size detailed on the table below.

Length (m)	Wire size
100 to 200	0.5mm ² x 2 core
To 300	0.75mm ² x 2 core
To 400	1.25mm ² x 2 core
To 600	2.0mm ² x 2 core

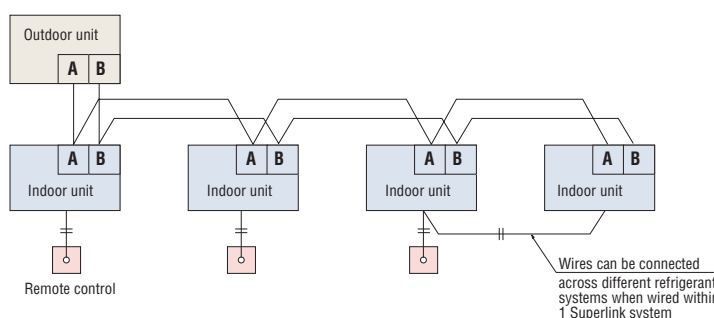

















Indoor units

Benefits Summary

When using RC-EX3A (Remote control), functions with symbol ● are available.
However, for RC-E5 (Remote control), functions with ※ are not available.

Energy Saving	Inverter technology	Inverter control technology functions at high efficiency with smooth operation from high speed to low speed. A smooth sine voltage wave is attained.
	Energy-saving ※	Since the capacity is controlled automatically based on the outdoor temperature, energy can be saved without losing comfort.
	Motion sensor ※	This sensor detects human activity and shifts the temperature setting according to the amount of activity in the room.
	Home leave operation ※	This function ensures that when the room is unoccupied for long periods of time, the unit will maintain a moderate indoor temperature, avoiding extremely hot or cool temperatures.
	Set temperature auto return ※	This function allows you to program a preferred set temperature that the unit will return to each time it is operated.
Comfort	Automatic operation	This function automatically selects the required heating or cooling function based on the current room conditions.
	Silent operation	This function allows you to program periods where the unit will operate with reduced noise levels, perfect for night time and an uninterrupted sleep.
	Hi power operation ※	Use the high power function to quickly reach your optimum temperature level when you first turn on the unit. This function will operate for a maximum of 15 minutes before returning to normal operation.
Air flow	Flap control system	This function allows you to set the upper and lower limit positions of the flap at each air outlet individually, providing you with complete control over interior air flow.
	Vertical auto swing	The vertical louvers on your unit will move up and down continuously during operation. This function allows you to set the up/down swing position of the louver to your preferred operation angle.
	Draft prevention setting ※	Draft Prevention setting provides a comfortable air flow without any draft feeling. Whether cooling or heating a room, the remote control can be used to instantly suppress any warm or cool drafts. This accurately assists how air flow is directed out of the indoor unit.
	Automatic fan speed	The unit's on-board microcomputer continuously monitors the room's air temperature and adjusts the air flow automatically.
Timer	Sleep timer	This function allows you to set a pre-determined amount of time between 30 and 240 minutes that your unit will operate for before switching off.
	Peak-cut timer ※	This function lets you to preset the capacity limit during certain periods of the day, minimising energy consumption during peak billing times, thus reducing operation costs.
	Weekly timer	Set your unit to turn on and off automatically on a weekly basis to suit your usual room usage on each day.
Convenient	Function Switch ※	From the eight available functions on the unit, this function allows you to set two functions to operate automatically.
	Favourite setting ※	Operation mode, set temperature, fan speed and air flow direction automatically adjust to the programmed favourite setting.
	Static pressure adjustment	This is operable when connecting duct type indoor units equipped with the external static pressure adjustment function. It will adjust the airflow accordingly based on the connected duct static pressure.
	Select the language ※	Set the language to be displayed on the remote control.
	Air filter	The air filter in the unit traps and removes airborne dust particles and other allergens to provide you with a clean air function.
	Filter sign	This warning alerts when the filter needs to be cleaned.
	Outside air intake	This function provides clean fresh air into the room through the external air intake, avoiding the constant recycling of internal air.
Others	Self diagnostics	The internal microcomputer automatically runs a diagnostic of the system in the event of a malfunction. This enables your authorised dealer to isolate and repair any issues.
	Built in drain pump	The built-in drain pump, allows greater flexibility with installation, offering a great solution for applications with limited space.
	Improved serviceability	The fan unit (comprised of impeller and motor) is easily accessible from either the side or bottom of the unit and can be slid out for easy maintenance.

	FDT	FDTC	FDTW	FDTS	FDTQ	FDU	FDUM	FDUT	FDUH	FDK	FDE	FDW	FDL	FDU	FDU-F
															
	●	●	●	●	●	●	●	●	●	●	●	●	●	●	●
	●	●	●	●	●	●	●	●	●	●	●	●	●	●	●
	● Option	● Option	● Option	● Option		● Option	● Option	● (71only) Option		● Option	● Option				● Option
	●	●	●	●	●	●	●	●	●	●	●	●	●	●	●
	●	●	●	●	●	●	●	●	●	●	●	●	●	●	●
	●	●	●	●	●	●	●	●	●	●	●	●	●	●	●
	●	●	●	●	●	●	●	●	●	●	●	●	●	●	●
	●	●	●	●	●	●	●	●	●	●	●	●	●	●	●
	●	●	●	●	●	●	●	●	●	●	●	●	●	●	●
ontrol	● Option	● Option													
	●	●	●	●	●	●	●	●	●	●	●	●	●	●	●
	●	●	●	●	●	●	●	●	●	●	●	●	●	●	●
	●	●	●	●	●	●	●	●	●	●	●	●	●	●	●
	●	●	●	●	●	●	●	●	●	●	●	●	●	●	●
	●	●	●	●	●	●	●	●	●	●	●	●	●	●	●
	●	●	●	●	●	●	●	●	●	●	●	●	●	●	●
						●	●	● (71only)							●
	●	●	●	●	●	●	●	●	●	●	●	●	●	●	●
	●	●	●	●	●	● procure locally	● Option	● Option	● Option	●	●	●	●	●	● procure locally
	●	●	●	●	●	●	●	●	●	●	●	●	●	●	●
air.	●	● Option	●	●	●	●	●	●	●						●
	●	●	●	●	●	●	●	●	●	●	●	●	●	●	●
	●	●	●	●	●	● *1	●	●	● Option						● *2
						●	●								

*1 : Except 224 • 280 *2 : Except 1800 • 2400



Ceiling Cassette -4way- FDT

Model No.

- FDT28KXZE1
- FDT36KXZE1
- FDT45KXZE1
- FDT56KXZE1
- FDT71KXZE1
- FDT90KXZE1
- FDT112KXZE1
- FDT140KXZE1
- FDT160KXZE1



Draft Prevention Panel (Option)

Remote control (option)

Wired



RC-EX3A

RC-E5

RCH-E3

Wireless



RCN-T-5AW-E2

Draft Prevention Panel

(Option)

Draft Prevention Panel prevents cold / hot draft being blown directly on the user.
It is possible to set Draft Prevention Panel for each air outlet.

Advanced airflow control technology cultivated through aircraft development.

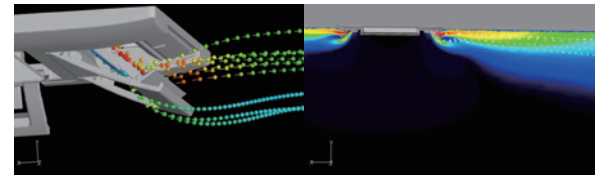
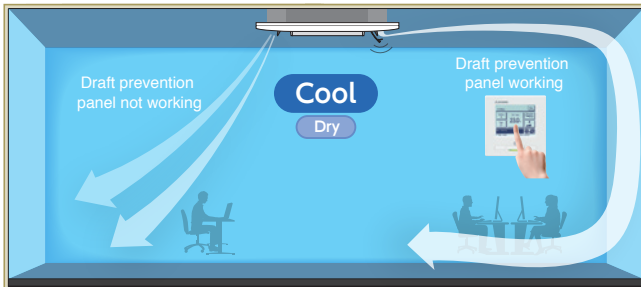

Draft Prevention Panel working

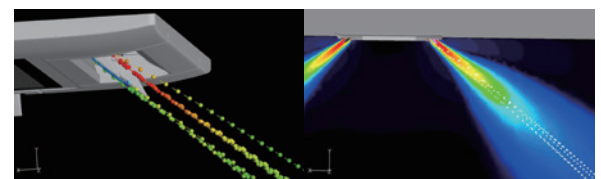

Draft Prevention Panel placed at off position

User can position panels by using the remote controller only (RC-EX3A, RCN-T-5AW-E2) when Draft Prevention Panel is available.

Motion Sensor

(Option)

Motion sensor is equipped in the corner of the panel and detects the presence/absence and activity of humans in a room to improve the comfort and energy saving performance of the unit.

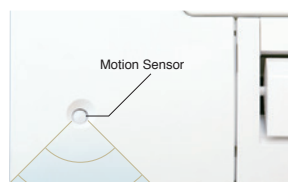

LB-T-5W-E

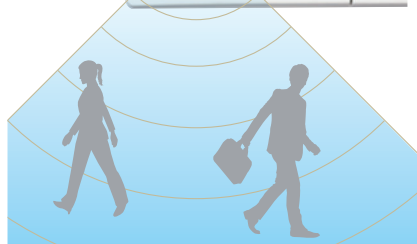

Improve the aerodynamic performance of the unit

New designed component has better aerodynamic performance and achieve lower noise.

New design turbo fan



Fan guard (standard equipment)



Panel select pattern

(Option)

8 patterns of panel are available.

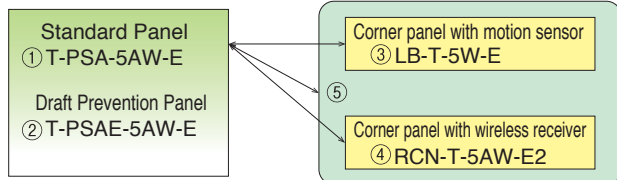

- ① Standard Panel only
- ①+③ Standard Panel with corner panel with motion sensor
- ①+④ Standard Panel with corner panel with wireless receiver
- ①+⑤ Standard Panel with corner panel with motion sensor & corner panel with wireless receiver
- ② Draft Prevention Panel only
- ②+③ Draft Prevention Panel with corner panel with motion sensor
- ②+④ Draft Prevention Panel with corner panel with wireless receiver
- ②+⑤ Draft Prevention Panel with corner panel with motion sensor & corner panel with wireless receiver

Installation position of Wireless kit and Motion sensor kit

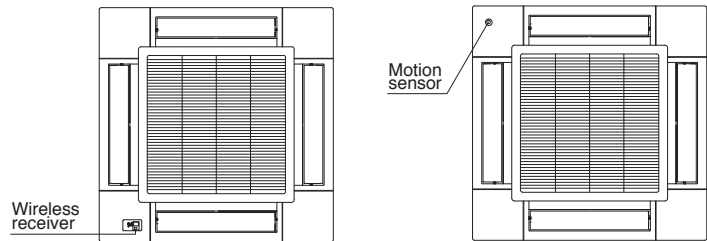

*Wireless receiver and Motion sensor can be installed to the position as shown

Individual flap control system

According to room conditions, four directions of air flow can be controlled individually by utilizing the flap control system. Individual flap control is available even after installation.

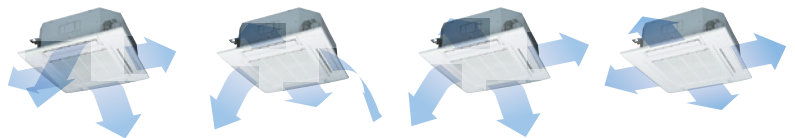

Flap can swing within an upper and lower flap range position within can be selected with a wired remote control.

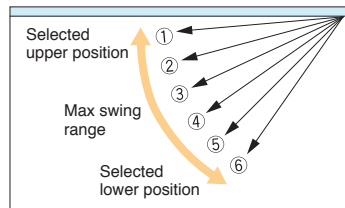

*The wireless remote control is not applicable to the Individual flap control system.



850mm Drain Pump

Drain can be discharged upwards by 850mm from the ceiling surface. It allows a piping layout with a high degree of freedom. Depending on the installation location and 185mm flexible hose as a standard equipment supports easy workability.

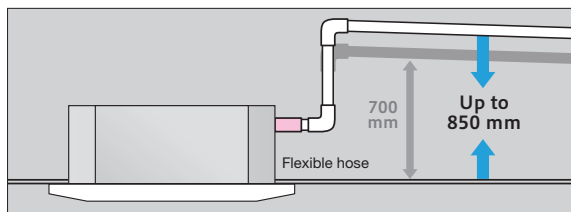

Suitable for High ceilings

The Powerful blowout of ultra high tap carry comfortable air flow to foot even in high ceiling. It is ideal for high ceiling offices and stores, etc., with a wide, uniform air flow throughout the room.

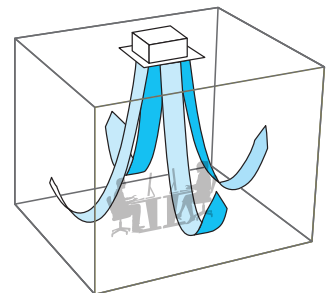

Easy check of drain pan

Easy inspection of the condition of the drain pan is possible by removing corner lid only.

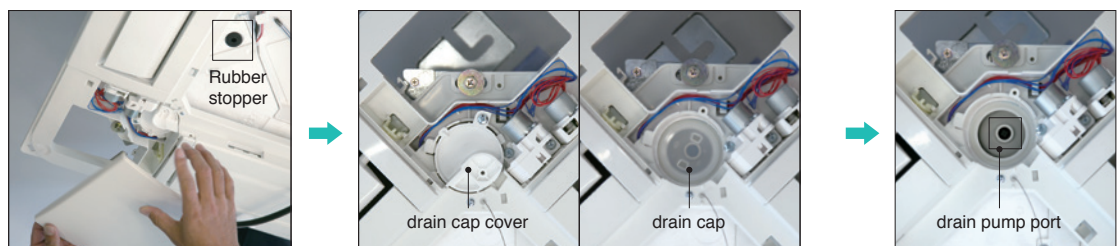

Remove corner lid.

Remove drain cap cover and check the condition. It is necessary to clean-up, firstly remove the rubber stopper to drain water out and secondly remove the drain cap.

Clean up the area around the drain pump port.



Specifications

Item	Model	FDT28KXZE1	FDT36KXZE1	FDT45KXZE1	FDT56KXZE1	FDT71KXZE1
Nominal cooling capacity	kW	2.8	3.6	4.5	5.6	7.1
Nominal heating capacity	kW	3.2	4.0	5.0	6.3	8.0
Power source		1 Phase 220-240V, 50Hz				
Power consumption	Cooling	0.04-0.04			0.07-0.07	0.08-0.08
	Heating	0.04-0.04			0.07-0.07	0.08-0.08
Sound power level	dB(A)	49		50	55	62
Sound pressure level	dB(A)	P-Hi:38 Hi:33 Me:30 Lo:28		P-Hi:38 Hi:33 Me:31 Lo:29	P-Hi:44 Hi:33 Me:31 Lo:29	P-Hi:47 Hi:35 Me:32 Lo:28
Exterior dimensions H x W x D	mm	Unit:236x840x840 Panel:35x950x950				
Net weight	kg	Unit:20 Standard Panel:5			Unit:21.5 Standard Panel:5	
Air flow	m ³ /min	P-Hi:20 Hi:14 Me:12 Lo:10	P-Hi:20 Hi:14 Me:12 Lo:10	P-Hi:20 Hi:15 Me:13 Lo:10	P-Hi:26 Hi:16 Me:13 Lo:11	P-Hi:28 Hi:17 Me:14 Lo:12
Outside air intake		Possible				
Panel		T-PSA-5AW-E, T-PSAE-5AW-E				
Air filter, Q'ty		Pocket Plastic net x1 (Washable)				
Remote control(option)		wired:RC-EX3A, RC-E5, RCH-E3 wireless:RCN-T-5AW-E2				
Installation data Refrigerant piping size	mm(in)	Liquid line:ø6.35(1/4") Gas line:ø9.52(3/8")	Liquid line:ø6.35(1/4") Gas line:ø12.7(1/2")			Liquid line:ø9.52(3/8") Gas line:ø15.88(5/8")

Item	Model	FDT90KXZE1	FDT112KXZE1	FDT140KXZE1	FDT160KXZE1
Nominal cooling capacity	kW	9.0	11.2	14.0	16.0
Nominal heating capacity	kW	10.0	12.5	16.0	18.0
Power source		1 Phase 220-240V, 50Hz			
Power consumption	Cooling	0.13-0.13	0.14-0.14		
	Heating	0.13-0.13	0.14-0.14		
Sound power level	dB(A)	65	66		
Sound pressure level	dB(A)	P-Hi:49 Hi:38 Me:36 Lo:31	P-Hi:49 Hi:39 Me:37 Lo:31	P-Hi:49 Hi:42 Me:39 Lo:32	P-Hi:49 Hi:42 Me:39 Lo:33
Exterior dimensions H x W x D	mm	Unit:298x840x840 Panel:35x950x950			
Net weight	kg	Unit:25 Standard Panel:5			
Air flow	m ³ /min	P-Hi:37 Hi:25 Me:22 Lo:15	P-Hi:38 Hi:26 Me:23 Lo:17	P-Hi:38 Hi:28 Me:25 Lo:18	P-Hi:38 Hi:29 Me:26 Lo:19
Outside air intake		Possible			
Panel		T-PSA-5AW-E, T-PSAE-5AW-E			
Air filter, Q'ty		Pocket Plastic net x1 (Washable)			
Remote control(option)		wired:RC-EX3A, RC-E5, RCH-E3 wireless:RCN-T-5AW-E2			
Installation data Refrigerant piping size	mm(in)	Liquid line:ø9.52(3/8") Gas line:ø15.88(5/8")			

1. The data are measured under the following conditions(ISO-T1). Cooling: Indoor temp. of 27°CDB, 19°CWB, and outdoor temp. of 35°CDB. Heating: Indoor temp. of 20°CDB, and outdoor temp. of 7°CDB, 6°CWB.
2. Sound pressure level indicates the value in an anechoic chamber. During operation these values are somewhat higher due to ambient conditions.





Ceiling Cassette -4way Compact FDTC

NEW

Model No.

- FDTC15KXZE1
- FDTC22KXZE1
- FDTC28KXZE1
- FDTC36KXZE1
- FDTC45KXZE1
- FDTC56KXZE1



Draft Prevention Panel (option)

Remote control (option)

Wired



RC-EX3A RC-E5 RCH-E3

Wireless



RCN-TC-5AW-E2

European design & Flat panel



Thin Panel

Big Louver

Unique Grille Design

Compact Design

□700mm → □620mm

It's only 14kg

Height of thin panel and main body is only 248 mm allowing it to be a very easy installation.

Integrated ceiling system design 600x600

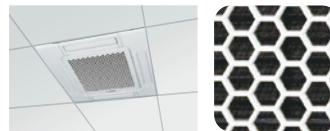

A grille designed with a unique structure and a clean white panel that blends with the room. This design was invented by zweigrad GmbH & Co. KG in Germany.

Taking OA (Outside Air) into inside

Fresh air can be taken in without optional parts. When the fresh air is insufficient, optional parts can be used.

- OA Spacer TC-OAS-E2(option)
- Joint Duct TC-OAD-E(option)

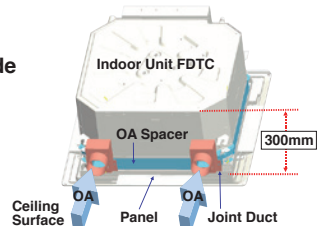

Draft Prevention Panel

(Option)

Draft Prevention Panel prevents cold/hot draft being blown directly on the user. It is possible to set Draft Prevention Panel for each air outlet.

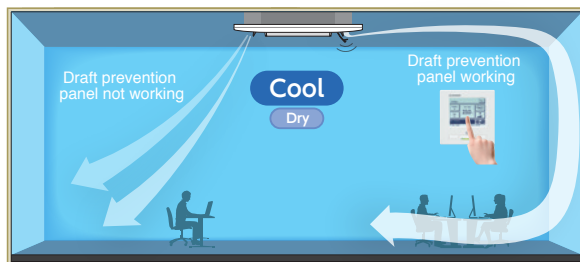

User can position panels by using the remote controller only (RC-EX3A, RCN-TC-5AW-E2) when Draft Prevention Panel is available.

Individual flap control system

According to room temperature conditions, four directions of air flow can be controlled individually by following Flap control system.



Individual flap control is available even after installation.

The flap can swing within the range of upper and lower flap position selected with wired remote control.

*The wireless remote control is not applicable to the Individual flap control system.

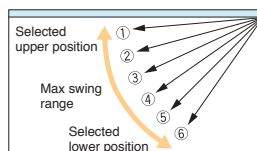

Motion Sensor

(Option)

Motion sensor is equipped in the corner of the panel and detects the presence/absence and activity of humans in a room to improve the comfort and energy saving performance of the unit.



LB-TC-5W-E

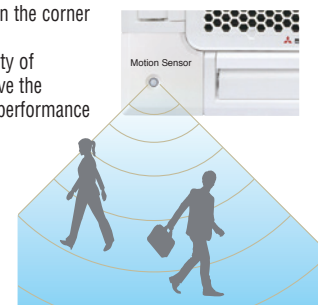

Panel select pattern

(Option)

8 patterns of panel are available. Please refer to P69.

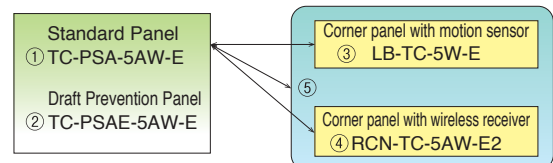

850mm Drain Pump

Drain can be discharged upward by 850 mm from the ceiling surface close to the indoor unit. It allows a piping layout with a high degree of freedom depending on the installation location.

Specifications

Item	Model	FDTC15KXZE1	FDTC22KXZE1	FDTC28KXZE1	FDTC36KXZE1	FDTC45KXZE1	FDTC56KXZE1	
Nominal cooling capacity	kW	1.5	2.2	2.8	3.6	4.5	5.6	
Nominal heating capacity	kW	1.7	2.5	3.2	4.0	5.0	6.3	
Power source		1 Phase 220-240V, 50Hz						
Power consumption	Cooling	0.03-0.03			0.04-0.04		0.05-0.05	0.06-0.06
	Heating	0.03-0.03			0.04-0.04		0.05-0.05	0.06-0.06
Sound power level	dB(A)	Cooling:47 Heating:46		49		Cooling:54 Heating:53	Cooling:58 Heating:57	60
Sound pressure level	Cooling	P-Hi:33 Hi:30 Me:28 Lo:25		P-Hi:35 Hi:32 Me:29 Lo:25		P-Hi:39 Hi:36 Me:31 Lo:26	P-Hi:43 Hi:39 Me:36 Lo:28	P-Hi:47 Hi:43 Me:39 Lo:31
	Heating	P-Hi:33 Hi:30 Me:26 Lo:22		P-Hi:35 Hi:32 Me:29 Lo:25		P-Hi:39 Hi:36 Me:31 Lo:26	P-Hi:43 Hi:39 Me:36 Lo:28	P-Hi:47 Hi:43 Me:39 Lo:31
Exterior dimensions H x W x D	mm	Unit:248x570x570 Panel:10x620x620						
Net weight	kg	Unit:12.5 Standard Panel:2.5		Unit:13 Standard Panel:2.5		Unit:14 Standard Panel:2.5		
Air flow	Cooling	P-Hi:8 Hi:7 Me:6 Lo:5		P-Hi:9 Hi:8 Me:7 Lo:6		P-Hi:10 Hi:9 Me:8 Lo:6	P-Hi:12 Hi:10 Me:9 Lo:7	P-Hi:14 Hi:12 Me:10 Lo:8
	Heating	P-Hi:8 Hi:7 Me:6 Lo:5		P-Hi:9 Hi:8 Me:7 Lo:6		P-Hi:10 Hi:9 Me:8 Lo:6	P-Hi:12 Hi:10 Me:9 Lo:7	P-Hi:14 Hi:12 Me:10 Lo:8
Outside air intake		Possible						
Panel		TC-PSA-5AW-E, TC-PSAE-5AW-E						
Air filter, Q'ty		Pocket Plastic net x1 (Washable)						
Remote control(option)		wired:RC-EX3A, RC-E5, RCH-E3 wireless:RCN-TC-5AW-E2						
Installation data		Liquid line:ø6.35(1/4")			Liquid line:ø6.35(1/4")			
Refrigerant piping size	mm(in)	Gas line:ø9.52(3/8")			Gas line:ø12.7(1/2")			

1. The data are measured under the following conditions(ISO-T1). Cooling: Indoor temp. of 27°CDB, 19°CWB, and outdoor temp. of 35°CDB. Heating: Indoor temp. of 20°CDB, and outdoor temp. of 7°CDB, 6°CWB.
 2. Sound pressure level indicates the value in an anechoic chamber. During operation these values are somewhat higher due to ambient conditions.

Dimensions

All measurements in mm.

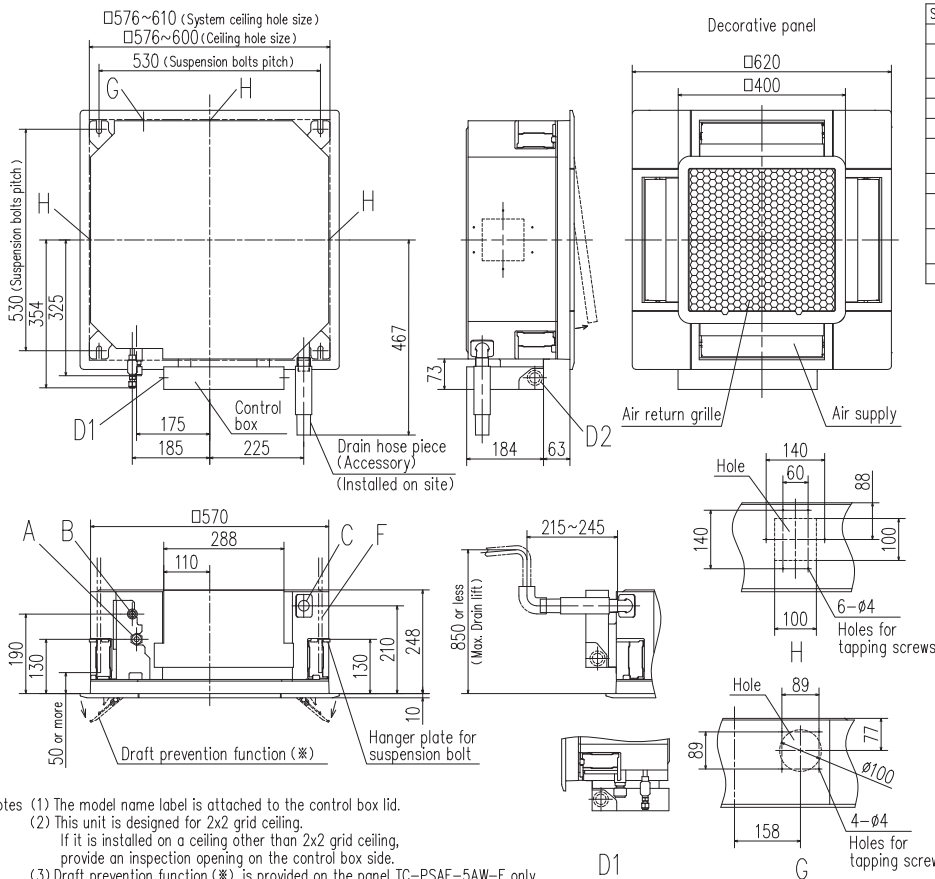

Symbol	Content		
	Model	15,22,28	36,45,56
A	Gas piping	ø9.52 (3/8") (Flare)	ø12.7 (1/2") (Flare)
B	Liquid piping	ø6.35 (1/4") (Flare)	
C	Drain piping	VP25 (O.D.32)	
D1	Power supply connection		
D2	Remote control code and signal wiring connection		
F	Suspension bolts	(M10 or M8)	
G	Outside air opening for ducting	(Knock out)	
H	Air outlet opening for ducting	ø125 (Knock out)	
J	Inspection opening	450X450	

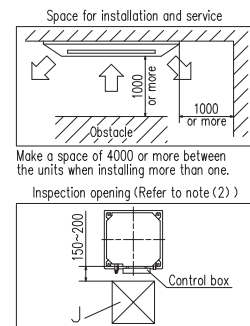

Make a space of 4000 or more between the units when installing more than one.
 Inspection opening (Refer to note (2))

- Notes (1) The model name label is attached to the control box lid.
 (2) This unit is designed for 2x2 grid ceiling.
 If it is installed on a ceiling other than 2x2 grid ceiling, provide an inspection opening on the control box side.
 (3) Draft prevention function (※) is provided on the panel TC-PSAE-5AW-E only.



Ceiling Cassette -2way- FDTW

Model No.

FDTW28KXE6F	FDTW90KXE6F
FDTW45KXE6F	FDTW112KXE6F
FDTW56KXE6F	FDTW140KXE6F
FDTW71KXE6F	



Remote control (option)

Wired



RC-EX3A RC-E5 RCH-E3

Wireless



RCN-TW-E2

Individual flap control system

According to room temperature conditions, four directions air flow can be controlled individually by flap control system. Due to optimization of outlet design of air flow our new advanced technology, sufficient air flow is secured and long reach of air flow is achieved.

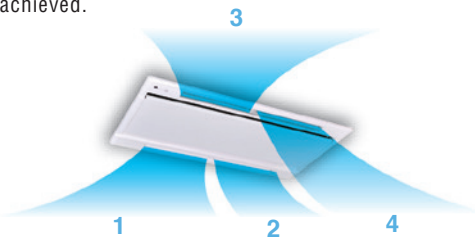

The flap can swing within the range of upper and lower flap position selected with wired remote control.

*The wireless remote control is not applicable to the individual flap control system.

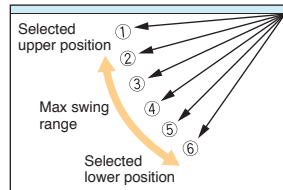

750mm Drain Pump

Drain can be discharged upward by 750mm from the ceiling surface close to the indoor unit. It allows a piping layout with a high degree of freedom depending on the installation location.

Installation workability

Drainage spout

Drainage flow test can be done easily by use of this drainage spout.



Transparent access hole to drain pan

Condition of the bottom of a drain pan can be checked through this transparent access hole without removing drain pan.

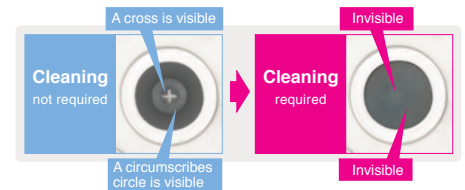

Motion Sensor

NEW

(Option)

Motion sensor is equipped in the corner of the panel and detects the presence/absence and activity of humans in a room to improve the comfort and energy saving performance of the unit.



LB-TW-6W

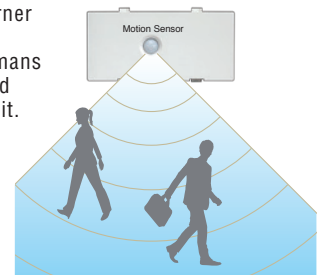

Specifications

Item	Model	FDTW28KXE6F	FDTW45KXE6F	FDTW56KXE6F	FDTW71KXE6F	FDTW90KXE6F	FDTW112KXE6F	FDTW140KXE6F	
Nominal cooling capacity	kW	2.8	4.5	5.6	7.1	9.0	11.2	14.0	
Nominal heating capacity	kW	3.2	5.0	6.3	8.0	10.0	12.5	16.0	
Power source		1 Phase 220-240V, 50Hz							
Power consumption	Cooling	0.09-0.09	0.10-0.10		0.14-0.14	0.19-0.19			
	Heating	0.09-0.09	0.10-0.10		0.14-0.14	0.19-0.19			
Sound power level	dB(A)	58					65	—	
Sound pressure level	dB(A)	P-Hi:42 Hi:38 Me:34 Lo:31					P-Hi:48 Hi:45 Me:41 Lo:37		
Exterior dimensions	H x W x D	Unit:325x820x620 Panel:20x1120x680				Unit:325x1535x620 Panel:20x1835x680			
Net weight	kg	Unit:20 Panel:8.5	Unit:21 Panel:8.5		Unit:23 Panel:8.5	Unit:35 Panel:13			
Air flow	m ³ /min	P-Hi:14.5 Hi:12 Me:10 Lo:9					P-Hi:31 Hi:27 Me:23 Lo:20		
Outside air intake		Possible							
Panel		TW-PSA-26W-E				TW-PSA-46W-E			
Air filter, Q'ty		Pocket Plastic net x2 (Washable)				Pocket Plastic net x3 (Washable)			
Remote control(option)		wired:RC-EX3A, RC-E5, RCH-E3 wireless:RCN-TW-E2							
Installation data		Liquid line:ø6.35(1/4")		Liquid line:ø6.35(1/4")		Liquid line:ø9.52(3/8")			
Refrigerant piping size	mm(in)	Gas line:ø9.52(3/8")		Gas line:ø12.7(1/2")		Gas line:ø15.88(5/8")			

1. The data are measured under the following conditions(ISO-T1). Cooling: Indoor temp. of 27°CDB, 19°CWB, and outdoor temp. of 35°CDB. Heating: Indoor temp. of 20°CDB, and outdoor temp. of 7°CDB, 6°CWB.
2. Sound pressure level indicates the value in an anechoic chamber. During operation these values are somewhat higher due to ambient conditions.

Dimensions

All measurements in mm.

FDTW28KXE6F, 45KXE6F, 56KXE6F, 71KXE6F

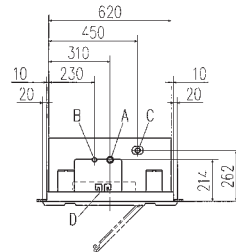
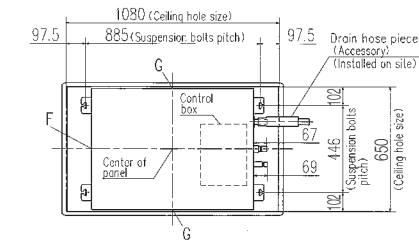

Symbol	Model	28	45, 56	71
A	Gas piping	φ9.52 (3/8") (Flare)	φ12.1 (1/2") (Flare)	φ13.88 (1/2") (Flare)
B	Liquid piping	φ6.35 (1/4") (Flare)	φ9.52 (3/8") (Flare)	φ12.1 (1/2") (Flare)
C	Drain piping	VP25 (O.D. 32)		
D	Hole for wiring			
E	Suspension bolts	(M10)		
F	Outside air opening for ducting	(Knock out)		
G	Air outlet opening for ducting	(Knock out)		

Notes (1) The model name label is attached on the lid of the control box.

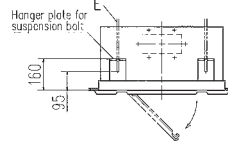
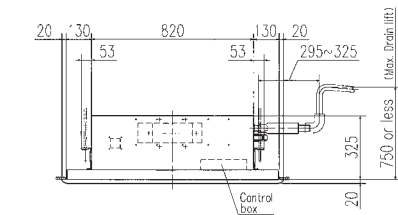

Space for installation and service

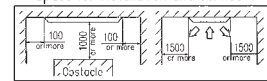

Make a space of 4000 or more between the units when installing more than one.

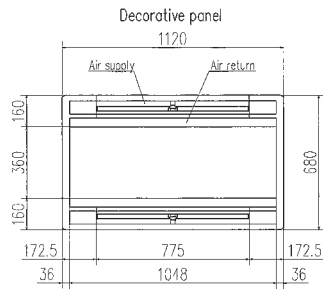

FDTW90KXE6F, 112KXE6F, 140KXE6F

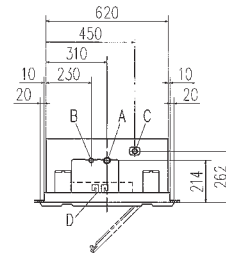
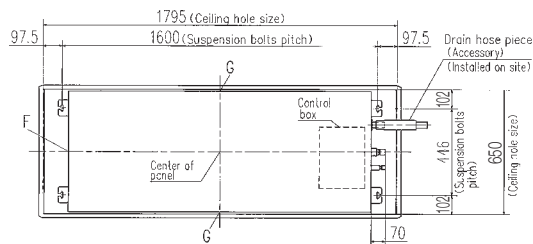

Symbol	Content
A	Gas piping φ15.88 (5/8") (Flare)
B	Liquid piping φ9.52 (3/8") (Flare)
C	Drain piping VP25 (O.D. 32)
D	Hole for wiring
E	Suspension bolts (M10)
F	Outside air opening for ducting (Knock out)
G	Air outlet opening for ducting (Knock out)

Notes (1) The model name label is attached on the lid of the control box.

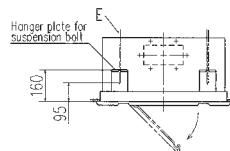
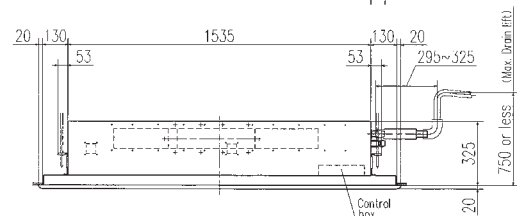

Space for installation and service

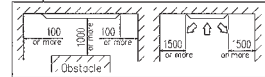

Make a space of 5000 or more between the units when installing more than one.

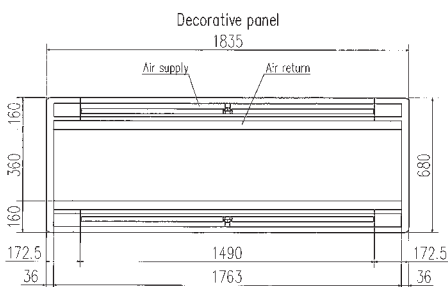



Ceiling Cassette -1way- FDTS

Model No.
FDTS45KXE6F
FDTS71KXE6F



Remote control (option)

Wired



RC-EX3A RC-E5 RCH-E3

Wireless



RCN-TS-E2

Individual flap control system

Two directions of air flow can be controlled individually by flap control system.



The flap can swing within the range of upper and lower flap position selected with wired remote control.

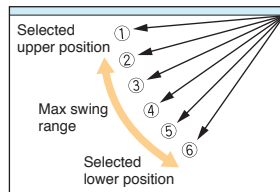

*The wireless remote control is not applicable to the individual flap control system.

Wireless remote control

For wireless remote control simply attach an additional panel with infrared receiver on the right side of the main decorative panel.



RCN-TS-E2

Compact design

Indoor unit size (W:1,150 x D:565) brings easy installation for 1,200 x 600 ceiling and Panel size (1,250 x 650) is suitable for 1,200 x 600 ceiling. Height is the industry's lowest height level 220mm and weight is 27/28kg only.

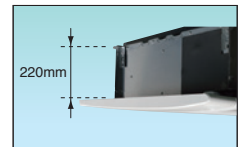

Motion Sensor

NEW

(Option)

Motion sensor is equipped in the ceiling plane or wall plane and detects the presence/absence and activity of humans in a room to improve the comfort and energy saving performance of the unit.



LB-KIT

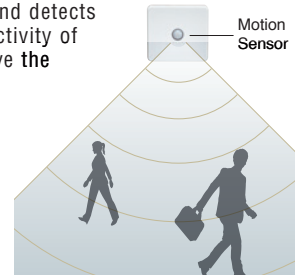

600mm Drain Pump

Drain can be discharged upward by 600mm from the ceiling surface close to the indoor unit. It allows a piping layout with a high degree of freedom depending on the installation location.

Specifications

Item	Model	FDTS45KXE6F	FDTS71KXE6F
Nominal cooling capacity	kW	4.5	7.1
Nominal heating capacity	kW	5.0	8.0
Power source		1 Phase 220-240V, 50Hz	
Power consumption	Cooling	0.04-0.04	0.09-0.09
	Heating	0.04-0.04	0.09-0.09
Sound power level	dB(A)	60	61
Sound pressure level	dB(A)	P-Hi:42 Hi:40 Me:38 Lo:35	P-Hi:49 Hi:46 Me:41 Lo:36
Exterior dimensions H x W x D	mm	Unit:220x1150x565 Panel:35x1250x650	
Net weight	kg	Unit:27 Panel:5	Unit:28 Panel:5
Air flow	m ³ /min	P-Hi:13 Hi:12 Me:11 Lo:9.5	P-Hi:17 Hi:15 Me:12 Lo:9.5
Outside air intake		Possible	
Panel		TS-PSA-3AW-E	
Air filter, Q'ty		Pocket Plastic net x2 (Washable)	
Remote control(option)		wired:RC-EX3A, RC-E5, RCH-E3 wireless:RCN-TS-E2	
Installation data Refrigerant piping size	mm(in)	Liquid line:ø6.35(1/4")	Liquid line:ø9.52(3/8")
		Gas line:ø12.7(1/2")	Gas line:ø15.88(5/8")

1. The data are measured under the following conditions(ISO-T1). Cooling: Indoor temp. of 27°CDB, 19°CWB, and outdoor temp. of 35°CDB. Heating: Indoor temp. of 20°CDB, and outdoor temp. of 7°CDB, 6°CWB.
2. Sound pressure level indicates the value in an anechoic chamber. During operation these values are somewhat higher due to ambient conditions.

Dimensions

All measurements in mm.

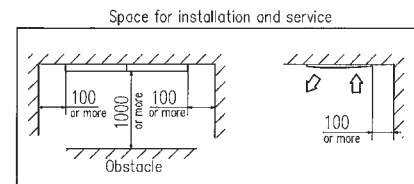
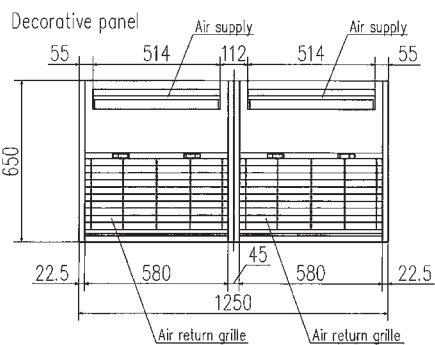
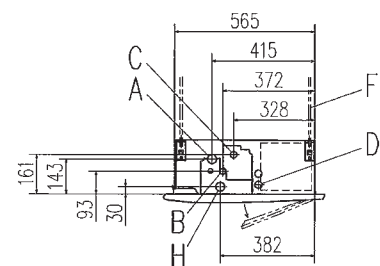
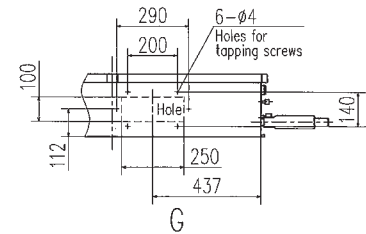
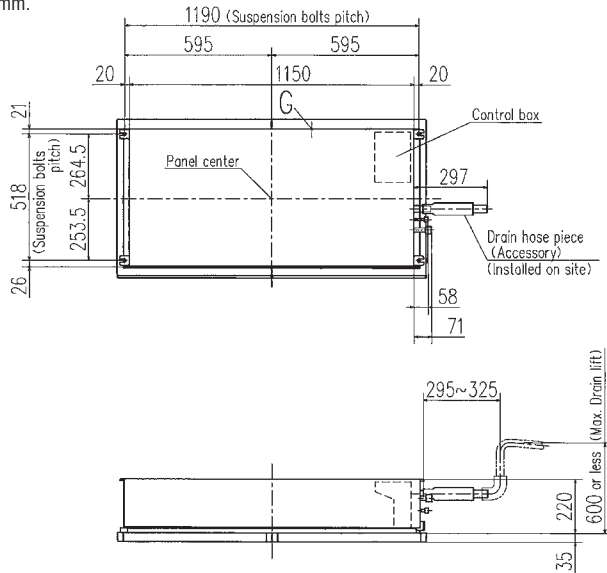

Make a space of 4000 or more between the units when installing more than one.

Symbol	Content		
	Model	45	71
A	Gas piping	φ12.7 (1/2") (Flare)	φ15.88 (5/8") (Flare)
B	Liquid piping	φ6.35 (1/4") (Flare)	φ9.52 (3/8") (Flare)
C	Drain piping	VP25 (O.D.32)	
D	Hole for wiring		
F	Suspension bolts	(M10)	
G	Outside air opening for ducting	(Knock out)	
H	Drain piping (Gravity drainage)	VP25 (I.D.25 , O.D.32)	



Ceiling Cassette -1way Compact-FDTQ

Model No.
 FDTQ22KXE6F
 FDTQ28KXE6F
 FDTQ36KXE6F



Fits into standard
600 x 600 ceiling

Remote control (option)

Wired



RC-EX3A RC-E5 RCH-E3

Wireless



RCN-KIT4-E2

Compact design

- Comfortable effective cooling for small rooms, with low fan speed air flow at just 5.4m³/min.



Optional wide panel shown for solid ceiling

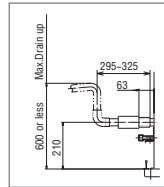

Condensate drain pump included as standard

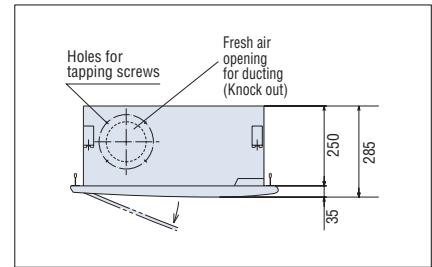

Ultra slim design at just 250mm above the ceiling

Specifications

Item	Model	FDTQ22KXE6F				FDTQ28KXE6F				FDTQ36KXE6F			
Panel Name		Direct blow panel		Duct panel		Direct blow panel		Duct panel		Direct blow panel		Duct panel	
Panel mode (Option)		TQ-PSA-15W-E	TQ-PSB-15W-E	QR-PNA-14W-ER	QR-PNB-14W-ER	TQ-PSA-15W-E	TQ-PSB-15W-E	QR-PNA-14W-ER	QR-PNB-14W-ER	TQ-PSA-15W-E	TQ-PSB-15W-E	QR-PNA-14W-ER	QR-PNB-14W-ER
Nominal cooling capacity	kW	2.2				2.8				3.6			
Nominal heating capacity	kW	2.5				3.2				4.0			
Power source		1 Phase 220-240V, 50Hz											
Power consumption	Cooling	0.05-0.07				0.05-0.07				0.05-0.07			
	Heating	0.05-0.07				0.05-0.07				0.05-0.07			
Sound power level	dB(A)	60											
Sound pressure level	dB(A)	P-Hi:45 Hi:41 Me:38 Lo:33				P-Hi:45 Hi:41 Me:38 Lo:33				P-Hi:45 Hi:41 Me:38 Lo:33			
Exterior dimensions	Unit	250x570x570											
	H x W x D Panel	mm	35x625x650	35x780x650	35x625x650	35x780x650	35x625x650	35x780x650	35x625x650	35x780x650	35x625x650	35x780x650	35x625x650
Net weight	kg	Unit:23 Panel:2.5	Unit:23 Panel:3	Unit:23 Panel:2.5	Unit:23 Panel:3	Unit:23 Panel:2.5	Unit:23 Panel:3	Unit:23 Panel:2.5	Unit:23 Panel:3	Unit:23 Panel:2.5	Unit:23 Panel:3	Unit:23 Panel:2.5	Unit:23 Panel:3
Air flow	m ³ /min	P-Hi:8 Hi:7 Me:6 Lo:5				P-Hi:8 Hi:7 Me:6 Lo:5				P-Hi:8 Hi:7 Me:6 Lo:5			
Outside air intake		Possible											
Air filter, Q'ty		Pocket Plastic net x1 (Washable)											
Remote control(option)		wired:RC-EX3A, RC-E5, RCH-E3 wireless:RCN-KIT4-E2											
Installation data		Liquid line:ø6.35(1/4") Gas line:ø9.52(3/8")											
Refrigerant piping size	mm(in)	Liquid line:ø6.35(1/4") Gas line:ø12.7(1/2")											

1. The data are based on the following conditions(SO-T1). Cooling: Indoor temp. of 27°CDB, 19°CWB, and outdoor temp. of 35°CDB. Heating: Indoor temp. of 20°CDB, and outdoor temp. of 7°CDB, 6°CWB.
 2. Sound pressure level indicates the value in an anechoic chamber. During operation these values are somewhat higher due to ambient conditions.

Dimensions

All measurements in mm.

Direct blow panel (TQ-PSA-15W-E)

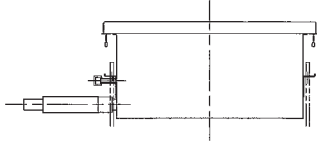

Direct blow panel (TQ-PSB-15W-E)

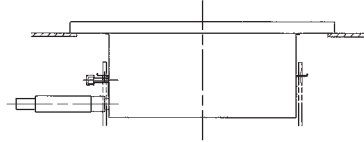

Symbol	Content	Model	FDTQ22KXE6F, 28KXE6F	FDTQ35KXE6F
A	Gas piping		φ9.52 (3/8") (Flare)	φ12.7 (1/2") (Flare)
B	Liquid piping		φ6.35 (1/4") (Flare)	
C	Drain piping		VP 25 (O.D. 32)	
D	Hole for wiring		φ30	
E	Suspension bolts		M10	
F1, F2	Outside air opening for ducting		(Knock out)	

Duct panel (QR-PNA-14W-ER)

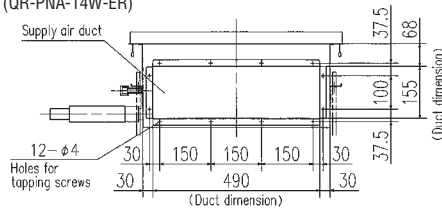

Duct panel (QR-PNB-14W-ER)

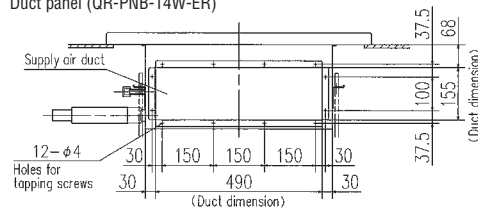

Notes

- (1) The model name label is attached on the fan case inside the air return grille.
- (2) This unit is designed for 2X2 grid ceiling.
- * In case of Direct blow panel

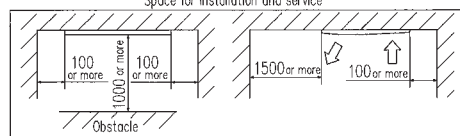
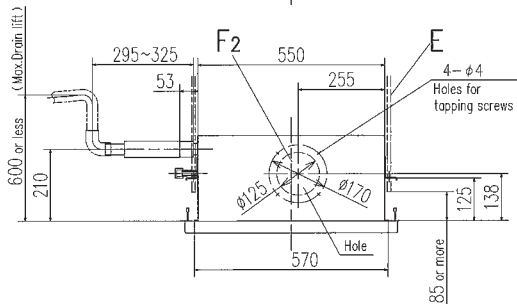
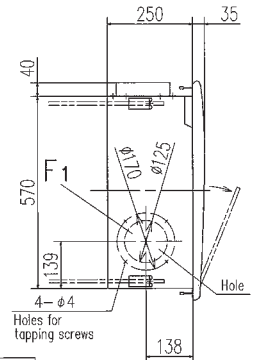
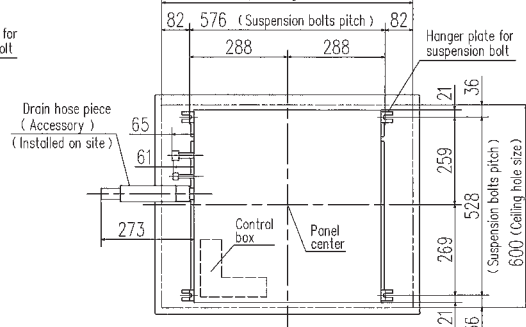
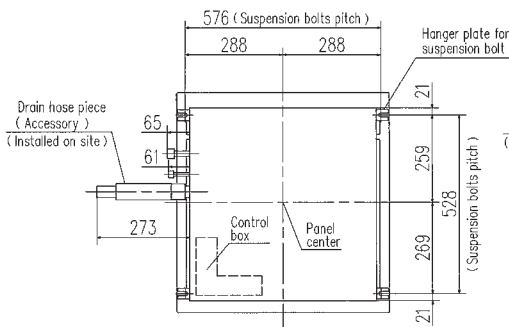

Make a space of 3000 or more between the units when installing more than one.

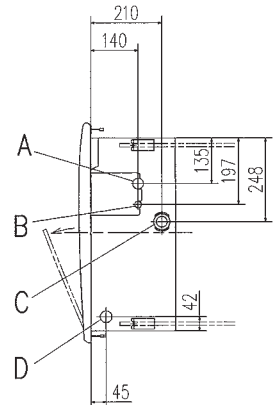
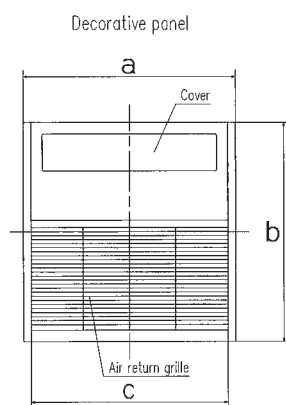
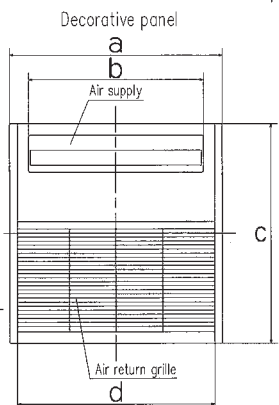

Dimension Table

Unit:mm

model	a	b	c	d
TQ-PSA-15W-E	625	514	650	580
TQ-PSB-15W-E	780	514	650	580

Dimension Table

Unit:mm

model	a	b	c
QR-PNA-14W-ER	625	650	580
QR-PNB-14W-ER	780	650	580



Duct Connected -High Static Pressure- FDU

- Model No.**
 FDU45KXE6F
 FDU56KXE6F
 FDU71KXE6F
 FDU90KXE6F
 FDU112KXE6F
 FDU140KXE6F
 FDU160KXE6F



- Model No.**
 FDU224KXZE1
 FDU280KXZE1

Remote control (option)

Wired



RC-EX3A RC-E5 RCH-E3

Wireless



RCN-KIT4-E2

External Static Pressure(E.S.P) control

The External Static Pressure (E.S.P.) can be manually set on the wired remote controller. Indoor unit will control the fan speed to keep rated air flow volume at each fan speed setting. You can set required E.S.P. by wired remote controller, calculated with the set air flow rate and the pressure loss of the duct.



E.S.P. button RC-E5
 External Static Pressure (E.S.P.) can be set by E.S.P. button.

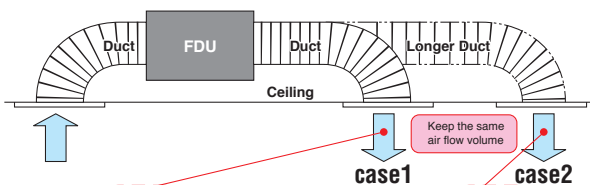

Setting No.	No.8	No.9	No.10	No.11	No.12	No.13	No.14	No.15
E.S.P.	80Pa	90Pa	100Pa	110Pa	120Pa	130Pa	140Pa	150Pa

*Range of 80~150 Pa is set at ex-factory default.
 Range of 10~200 Pa is available by setting SW8-4 switch on at site.

<Expansion of external static pressure range>

Previous **10~130Pa** → Current **10~200Pa**

Motion Sensor **NEW** (Option)

Motion sensor is equipped in the ceiling plane or wall plane and detects the presence/absence and activity of humans in a room to improve the comfort and energy saving performance of the unit.



LB-KIT

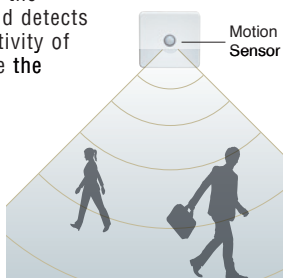

Thin design

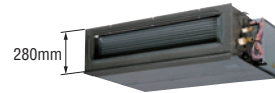

	Previous	Current	
FDU71KXE6F	297	280	17mm less!!
FDU112/140KXE6F	350	280	70mm less!!

Reduction of sound pressure level

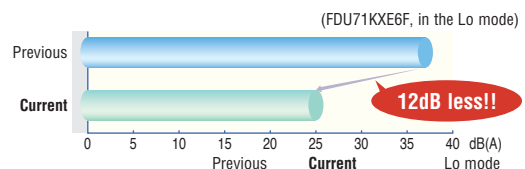

	Previous	Current	
FDU90KXE6F	37	25	12dB(A) less!!
FDU112KXE6F	38	30	8dB(A) less!!
FDU140KXE6F	39	29	10dB(A) less!!

Transparent inspection window

Dirt condition of the bottom of a drain pan can be checked through this transparent inspection window without removing drain pan. (Please refer to P74)

Improvement of the serviceability

Fan unit (impeller and motor) can be pulled out from the right side of the unit. Maintenance can be available from the right side or the bottom side. (Common for FDUM22~160KXE6F & FDU45~160KXE6F)

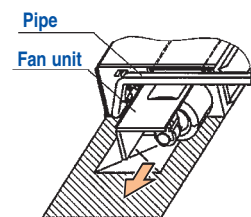

Specifications

Item	Model	FDU45KXE6F	FDU56KXE6F	FDU71KXE6F	FDU90KXE6F	FDU112KXE6F	FDU140KXE6F	FDU160KXE6F
Nominal cooling capacity	kW	4.5	5.6	7.1	9.0	11.2	14.0	16.0
Nominal heating capacity	kW	5.0	6.3	8.0	10.0	12.5	16.0	18.0
Power source		1 Phase 220-240V, 50Hz						
Power consumption	Cooling	0.10-0.10		0.24-0.25		0.31-0.32	0.35-0.36	0.42-0.43
	Heating	0.10-0.10		0.24-0.25		0.31-0.32	0.35-0.36	0.42-0.43
Sound power level	dB(A)	60		65		—		
Sound pressure level	dB(A)	P-Hi:37 Hi:32 Me:29 Lo:26		P-Hi:38 Hi:33 Me:29 Lo:25		P-Hi:44 Hi:38 Me:36 Lo:30	P-Hi:45 Hi:40 Me:34 Lo:29	P-Hi:47 Hi:40 Me:35 Lo:30
Exterior dimensions H x W x D	mm	280x750x635		280x950x635		280x1370x740		
Net weight	kg	29		34		54		
Air flow	m ³ /min	P-Hi:13 Hi:10 Me:9 Lo:8		P-Hi:24 Hi:19 Me:15 Lo:10		P-Hi:36 Hi:28 Me:25 Lo:19	P-Hi:39 Hi:32 Me:26 Lo:20	P-Hi:48 Hi:35 Me:28 Lo:22
Maximum external static pressure	Pa	200						
Outside air intake		Possible						
Air filter		Procure locally						
Remote control(option)		wired:RC-EX3A, RC-E5, RCH-E3 wireless:RCN-KIT4-E2						
Installation data Refrigerant piping size	mm(in)	Liquid line:ø6.35(1/4") Gas line:ø12.7(1/2")			Liquid line:ø9.52(3/8") Gas line:ø15.88(5/8")			

1. The data are measured under the following conditions(SO-T1). Cooling: Indoor temp. of 27°CDB, 19°CWB, and outdoor temp. of 35°CDB. Heating: Indoor temp. of 20°CDB, and outdoor temp. of 7°CDB, 6°CWB. External static pressure of indoor unit is 60Pa.

2. Sound pressure level indicates the value in an anechoic chamber. During operation these values are somewhat higher due to ambient conditions.

Item	Model	FDU224KXZE1	FDU280KXZE1
Nominal cooling capacity	kW	22.4	28.0
Nominal heating capacity	kW	25.0	31.5
Power source		1 Phase 220-240V, 50Hz	
Power consumption	Cooling	1.16-1.20	
	Heating	1.16-1.20	
Sound pressure level	dB(A)	P-Hi:52 Hi:50 Me:47 Lo:45	
Exterior dimensions H x W x D	mm	379x1600x893	
Net weight	kg	89	
Air flow	m ³ /min	P-Hi:80 Hi:72 Me:64 Lo:56	
Maximum external static pressure	Pa	200	
Outside air intake		Possible(on return duct)	
Air filter		Procure locally	
Remote control(option)		wired:RC-EX3A, RC-E5, RCH-E3 wireless:RCN-KIT4-E2	
Installation data Refrigerant piping size	mm(in)	Liquid line:ø9.52(3/8") Gas line:ø19.05(3/4")	Liquid line:ø9.52(3/8") Gas line:ø22.22(7/8")

1. The data are measured under the following conditions(SO-T1). Cooling: Indoor temp. of 27°CDB, 19°CWB, and outdoor temp. of 35°CDB. Heating: Indoor temp. of 20°CDB, and outdoor temp. of 7°CDB, 6°CWB. External static pressure of indoor unit is 72Pa.

2. Sound pressure level indicates the value in an anechoic chamber. During operation these values are somewhat higher due to ambient conditions.

Dimensions

All measurements in mm.

FDU45KXE6F, 56KXE6F

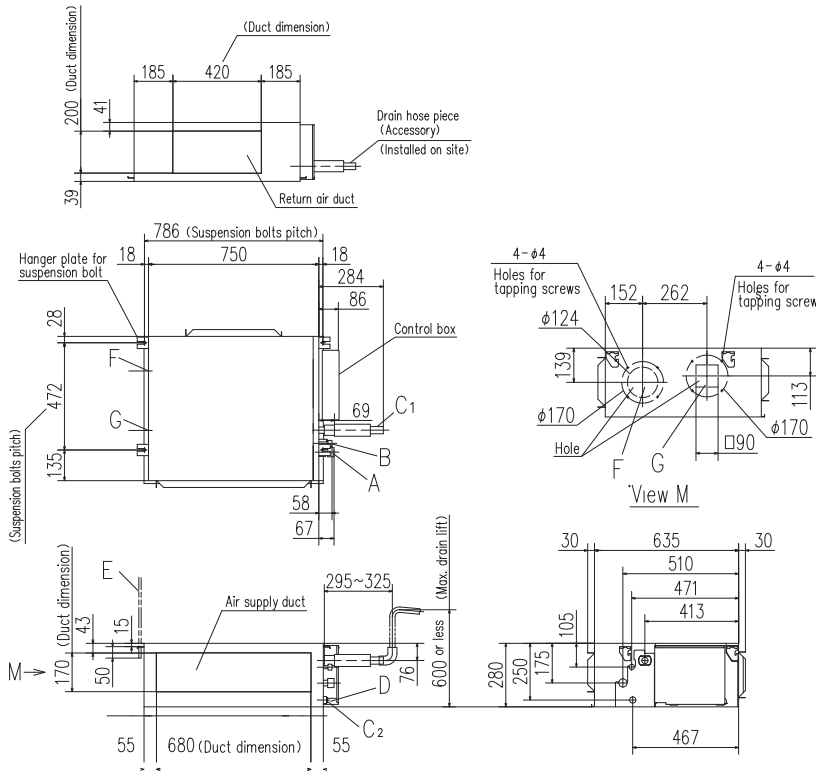

Symbol	Content
A	Gas piping φ12.7 (1/2") (Flare)
B	Liquid piping φ6.35 (1/4") (Flare)
C1	Drain piping VP25 (O.D.32)
C2	Drain piping (Gravity drainage) VP20
D	Hole for wiring
E	Suspension bolts M10
F	Outside air opening for ducting (Knock out)
G	Air outlet opening for ducting (Knock out)
H	Inspection opening (450X450)

Space for installation and service

Select either of two cases to keep space for installation and services.

(Case 1) From side of unit

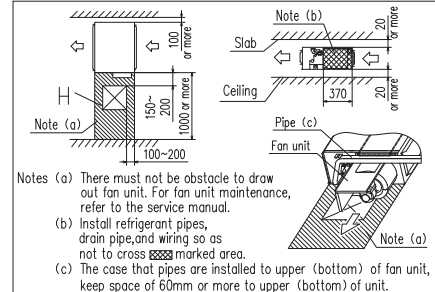

(Case 2) From bottom of unit

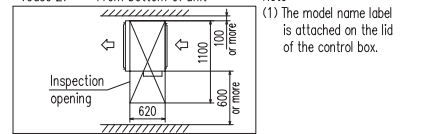

FDU71KXE6F, 90KXE6F

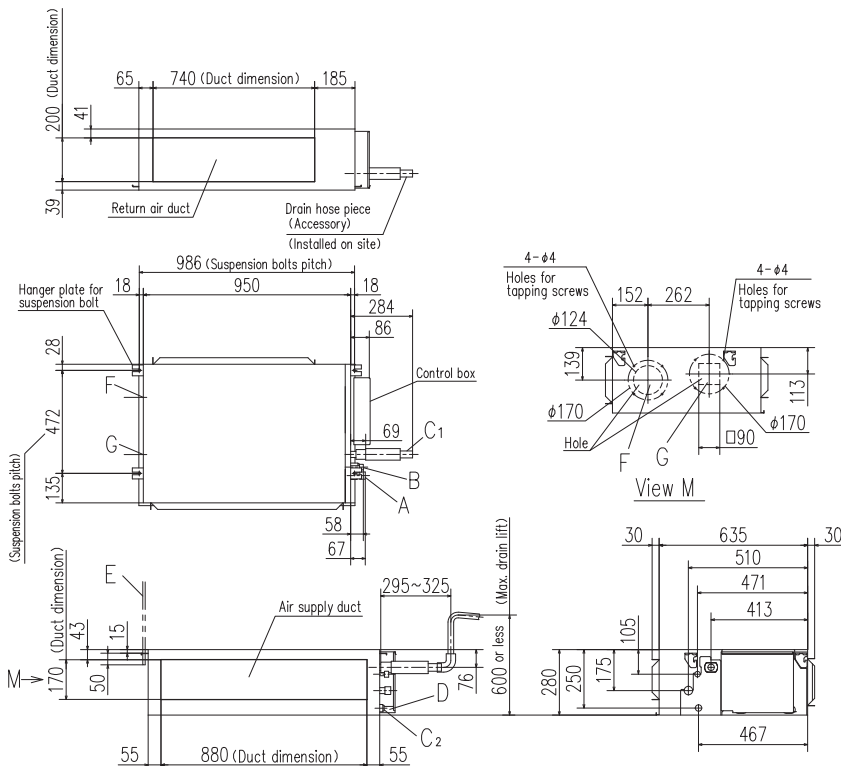

Symbol	Content
A	Gas piping φ15.88 (5/8") (Flare)
B	Liquid piping φ9.52 (3/8") (Flare)
C1	Drain piping VP25 (O.D.32)
C2	Drain piping (Gravity drainage) VP20
D	Hole for wiring
E	Suspension bolts M10
F	Outside air opening for ducting (Knock out)
G	Air outlet opening for ducting (Knock out)
H	Inspection opening (450X450)

Space for installation and service

Select either of two cases to keep space for installation and services.

(Case 1) From side of unit

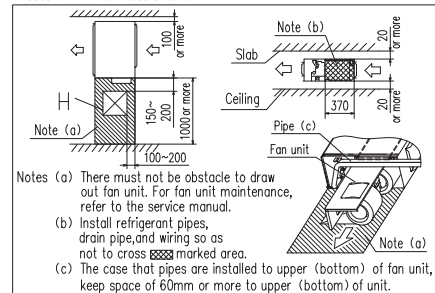

(Case 2) From bottom of unit

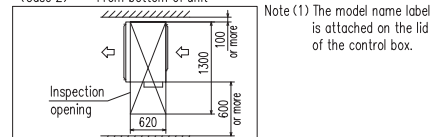

FDU112KXE6F, 140KXE6F, 160KXE6F

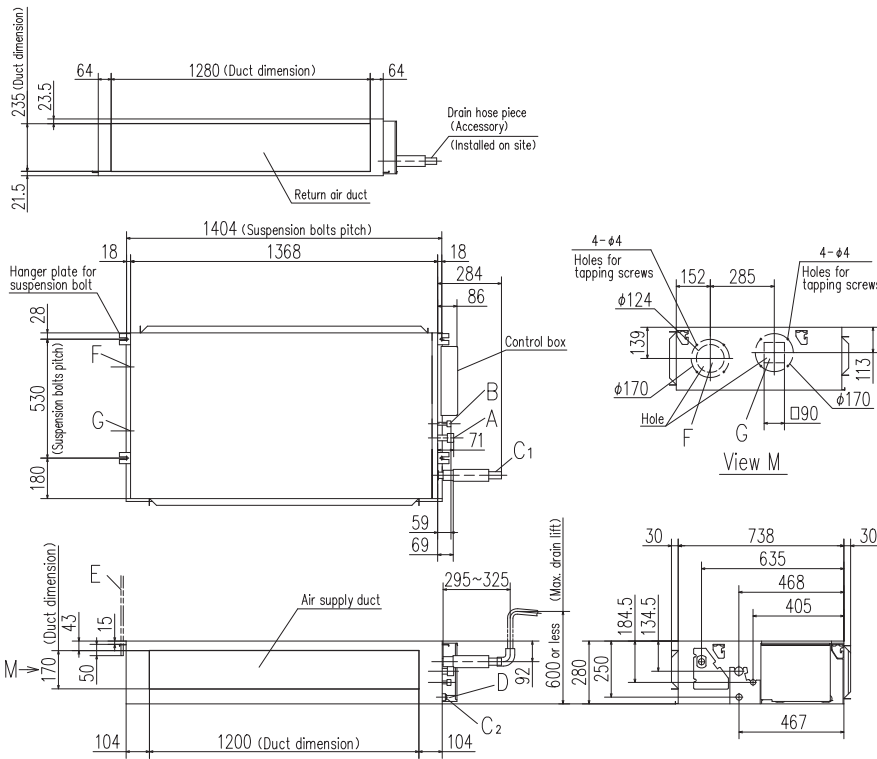

Symbol	Content	
A	Gas piping	φ15.88 (5/8") (Flare)
B	Liquid piping	φ9.52 (3/8") (Flare)
C1	Drain piping	VP25 (O.D.32)
C2	Drain piping (Gravity drainage)	VP20
D	Hole for wiring	
E	Suspension bolts	M10
F	Outside air opening for ducting	(Knock out)
G	Air outlet opening for ducting	(Knock out)
H	Inspection opening	(450X450)

Space for installation and service

Select either of two cases to keep space for installation and services.
(Case 1) From side of unit

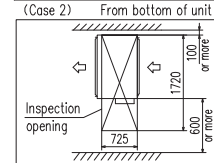
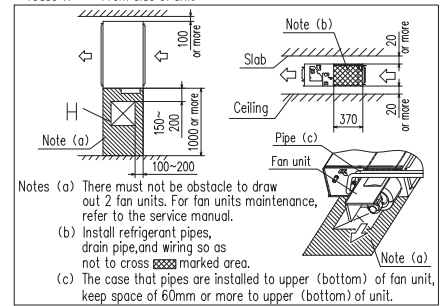

Note (1) The model name label is attached on the lid of the control box.

FDU224KXZE1, 280KXZE1

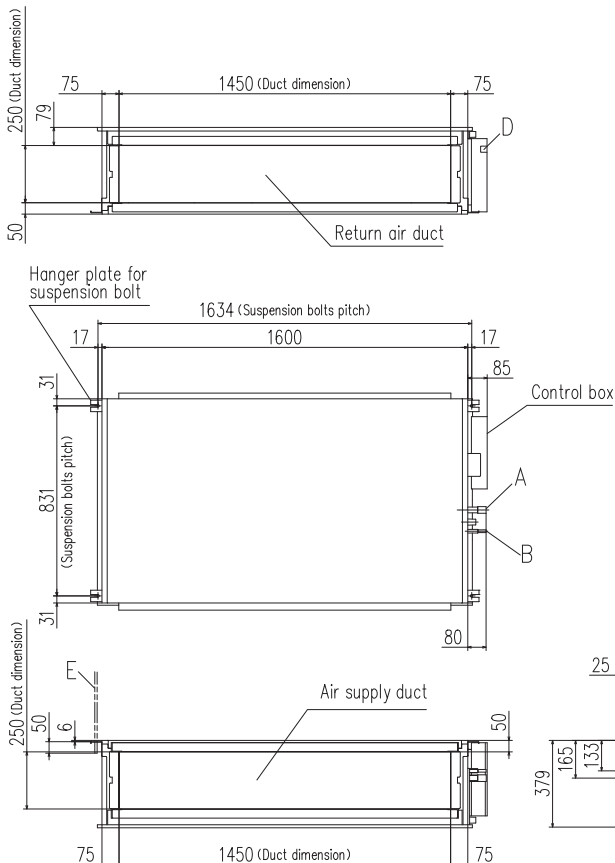

Symbol	Content		
	MODEL	224	280
A	Gas piping	φ19.05 (3/4") (Brazing)	φ22.22 (7/8") (Brazing)
B	Liquid piping	φ9.52 (3/8") (Brazing)	
C	Drain piping (Gravity drainage)	VP25 (O.D.32)	
D	Hole for wiring		
E	Suspension bolts	M10	
F	Inspection hole	(450X450)	

Space for installation and service

Select either of two cases to keep space for installation and services.
(Case 1) From side of unit

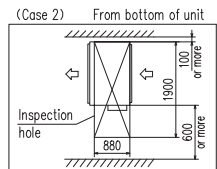
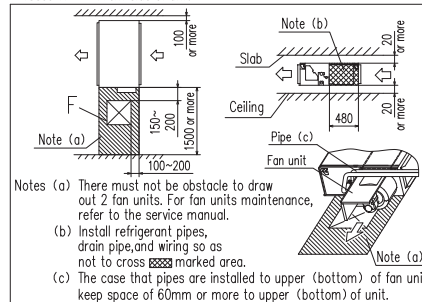

Notes (1) The model name label is attached on the lid of the control box.

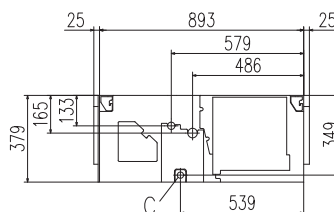



Duct Connected -Low/Middle Static Pressure- FDUM

Model No.

FDUM22KXE6F	FDUM71KXE6F
FDUM28KXE6F	FDUM90KXE6F
FDUM36KXE6F	FDUM112KXE6F
FDUM45KXE6F	FDUM140KXE6F
FDUM56KXE6F	FDUM160KXE6F



Remote control (option)



Filter kit (option)

UM-FL1EF : for 22~56
UM-FL2EF : for 71, 90
UM-FL3EF : for 112, 140, 160



* Filter pressure loss:5pa

Automatic external static pressure (E.S.P.) control

Duct design was simplified. Using DC motor, the most optimum air flow volume can be achieved by this automatic control. Indoor unit will recognize external static pressure by itself automatically and keep rated air flow volume.

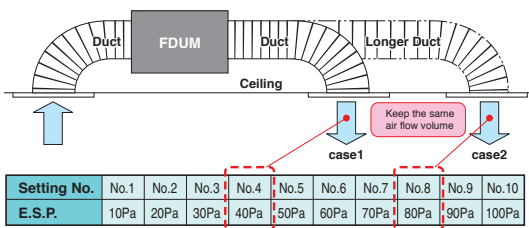

E.S.P. button RC-E5
External static pressure (E.S.P.) can be set by E.S.P. button.

Thin design

The height of all FDUM models is only 280mm.

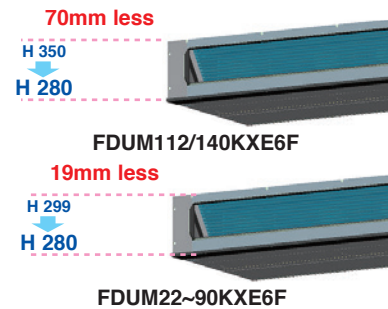

Motion Sensor

NEW

Motion sensor is equipped in the ceiling plane or wall plane and detects the presence/absence and activity of humans in a room to improve the comfort and energy saving performance of the unit.

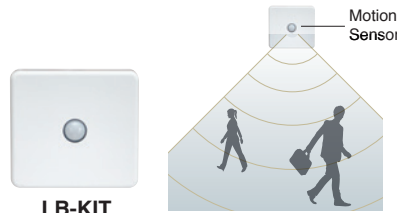

(Option)

Transparent inspection window

Dirt condition of the bottom of a drain pan can be checked through this transparent inspection window without removing drain pan. (Please refer to P74)

Specifications

Item	Model	FDUM22KXE6F	FDUM28KXE6F	FDUM36KXE6F	FDUM45KXE6F	FDUM56KXE6F	FDUM71KXE6F	FDUM90KXE6F	FDUM112KXE6F	FDUM140KXE6F	FDUM160KXE6F	
Nominal cooling capacity	kW	2.2	2.8	3.6	4.5	5.6	7.1	9.0	11.2	14.0	16.0	
Nominal heating capacity	kW	2.5	3.2	4.0	5.0	6.3	8.0	10.0	12.5	16.0	18.0	
Power source		1 Phase 220-240V, 50Hz										
Power consumption	Cooling	0.10-0.10					0.20-0.20			0.29-0.29	0.33-0.33	0.45-0.45
	Heating	0.10-0.10					0.20-0.20			0.29-0.29	0.33-0.33	0.45-0.45
Sound power level	dB(A)	60					65			—		
Sound pressure level	dB(A)	P-Hi:37 Hi:32 Me:29 Lo:26					P-Hi:38 Hi:33 Me:29 Lo:25			P-Hi:44 Hi:38 Me:36 Lo:30	P-Hi:45 Hi:40 Me:34 Lo:29	P-Hi:47 Hi:40 Me:35 Lo:22
Exterior dimensions H x W x D	mm	280 x 750 x 635					280 x 950 x 635			280 x 1370 x 740		
Net weight	kg	29					34			54		
Air flow	m ³ /min	P-Hi:13 Hi:10 Me:9 Lo:8					P-Hi:24 Hi:19 Me:15 Lo:10			P-Hi:36 Hi:28 Me:25 Lo:19	P-Hi:39 Hi:32 Me:26 Lo:20	P-Hi:48 Hi:35 Me:28 Lo:22
Maximum external static pressure	Pa	100										
Outside air intake		Possible										
Air filter		Filter kit:UM-FL1EF/UM-FL2EF/UM-FL3EF(option)										
Remote control(option)		wired:RC-EX3A, RC-E5, RCH-E3 wireless:RCN-KIT4-E2										
Installation data Refrigerant piping size	mm(in)	Liquid line:ø6.35(1/4") Gas line:ø9.52(3/8")			Liquid line:ø6.35(1/4") Gas line:ø12.7(1/2")			Liquid line:ø9.52(3/8") Gas line:ø15.88(5/8")				

1. The data are measured under the following conditions (ISO-T1). Cooling: Indoor temp. of 27°CDB, 19°CWB, and outdoor temp. of 35°CDB. Heating: Indoor temp. of 20°CDB, and outdoor temp. of 7°CDB, 6°CWB. External static pressure of indoor unit is 35Pa(22/28/36/45/56/71/90), 60Pa(112/140/160).
2. Sound pressure level indicates the value in an anechoic chamber. During operation these values are somewhat higher due to ambient conditions.



Duct Connected (thin) -Low Static Pressure- FDUT

Model No.
 FDUT15KXE6F-E
 FDUT22KXE6F-E
 FDUT28KXE6F-E
 FDUT36KXE6F-E
 FDUT45KXE6F-E
 FDUT56KXE6F-E
 FDUT71KXE6F-E

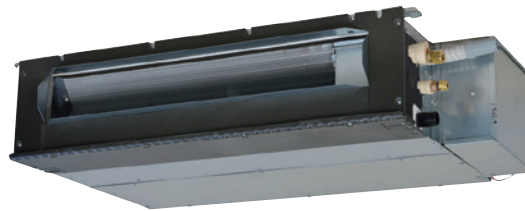

Remote control (option)

Wired



RC-EX3A RC-E5 RCH-E3

Wireless



RCN-KIT4-E2

Compact design

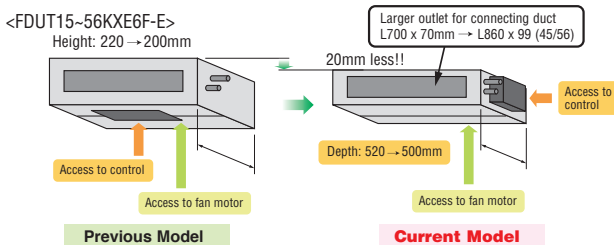

Lower noise

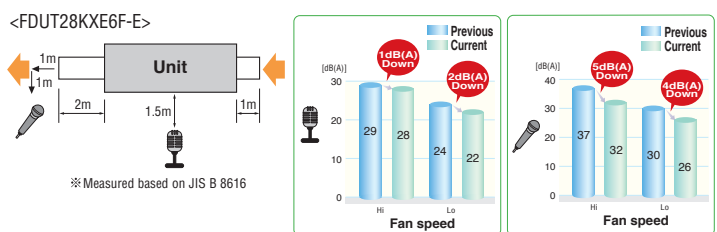

Motion Sensor **NEW** (Option)

Motion sensor is equipped in the ceiling plane or wall plane and detects the presence/absence and activity of humans in a room to improve the comfort and energy saving performance of the unit.

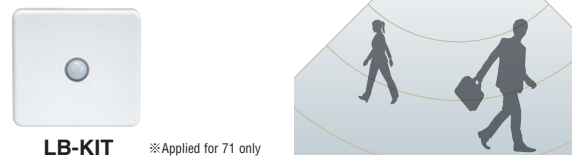

Duct kit and filter options

Item	Contents	for FDUT15/22/28/36KXE6F-E	for FDUT45/56KXE6F-E	for FDUT71KXE6F-E
Outlet duct plate	①	UT-SAT1EF	UT-SAT2EF	UT-SAT3EF
Filter set	②+③	UT-FL1EF	UT-FL2EF	UT-FL3EF

Filter pressure loss : 5 Pa

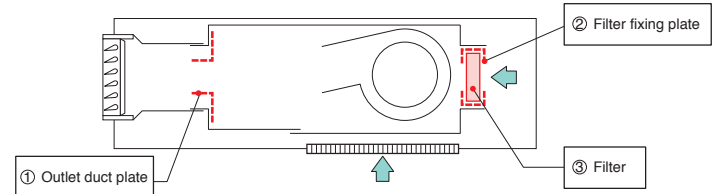

Specifications

Item	Model	FDUT15KXE6F-E	FDUT22KXE6F-E	FDUT28KXE6F-E	FDUT36KXE6F-E	FDUT45KXE6F-E	FDUT56KXE6F-E	FDUT71KXE6F-E	
Nominal cooling capacity	kW	1.5	2.2	2.8	3.6	4.5	5.6	7.1	
Nominal heating capacity	kW	1.7	2.5	3.2	4.0	5.0	6.0	8.0	
Power source		1 Phase 220-240V, 50Hz							
Power consumption	Cooling	0.06-0.06		0.07-0.07		0.08-0.08		0.08-0.08	
	Heating	0.06-0.06		0.07-0.07		0.08-0.08		0.07-0.07	
Sound power level	dB(A)	52			57	58	59		
Sound pressure level ①	dB(A)	Hi:28 Me:26 Lo:22	Hi:28 Me:26 Lo:22		Hi:33 Me:30 Lo:26	Hi:34 Me:32 Lo:28	Hi:35 Me:33 Lo:30	Hi:35 Me:31 Lo:28	
Sound pressure level ②	dB(A)	Hi:32 Me:29 Lo:25	Hi:32 Me:29 Lo:26		Hi:37 Me:34 Lo:28	Hi:36 Me:33 Lo:27	Hi:38 Me:33 Lo:29	Hi:41 Me:37 Lo:32	
Exterior dimensions H x W x D	mm	200x750x500				200x950x500		220x1150x565	
Net weight	kg	21			22	25		31	
Air flow (Standard)	m ³ /min	Hi:6 Me:5 Lo:4	Hi:7.5 Me:6 Lo:5		Hi:8.5 Me:7 Lo:5.5	Hi:11.5 Me:9 Lo:7	Hi:12.5 Me:9 Lo:7.2	Hi:16 Me:13 Lo:9.5	
External Static pressure	Pa	Standard:10, Max:35					Standard:10, Max:50		
Outside air intake		Possible from return duct							
Air filter		Filter set:UT-FL1EF/UT-FL2EF/UT-FL3EF(option)							
Remote control(option)		wired:RC-EX3A, RC-E5, RCH-E3 wireless:RCN-KIT4-E2							
Installation data Refrigerant piping size	mm(in)	Liquid line:ø6.35(1/4") Gas line:ø9.52(3/8")			Liquid line:ø6.35(1/4") Gas line:ø12.7(1/2")		Liquid line:ø9.52(3/8") Gas line:ø15.88(5/8")		

1. The data are measured under the following conditions(ISO-T1). Cooling: Indoor temp. of 27°CDB, 19°CWB, and outdoor temp. of 35°CDB. Heating: Indoor temp. of 20°CDB, and outdoor temp. of 7°CDB, 6°CWB. External static pressure of indoor unit is 10Pa.
 2. The data of nominal cooling and heating capacity and sound pressure level are measured with 10Pa of external static pressure.
 3. The sound level indicates the value of rear-intake type with duct in anechoic chamber. During operation these values are somewhat higher due to ambient conditions.
 4. Sound pressure levels are values when 2m supply duct and 1m return duct are connected.
 ①: Mike position is 1.5m below unit, ②: Mike position is 1m in front and 1m below the air supply duct.

Dimensions

All measurements in mm.

FDUT15KXE6F-E, 22KXE6F-E, 28KXE6F-E, 36KXE6F-E

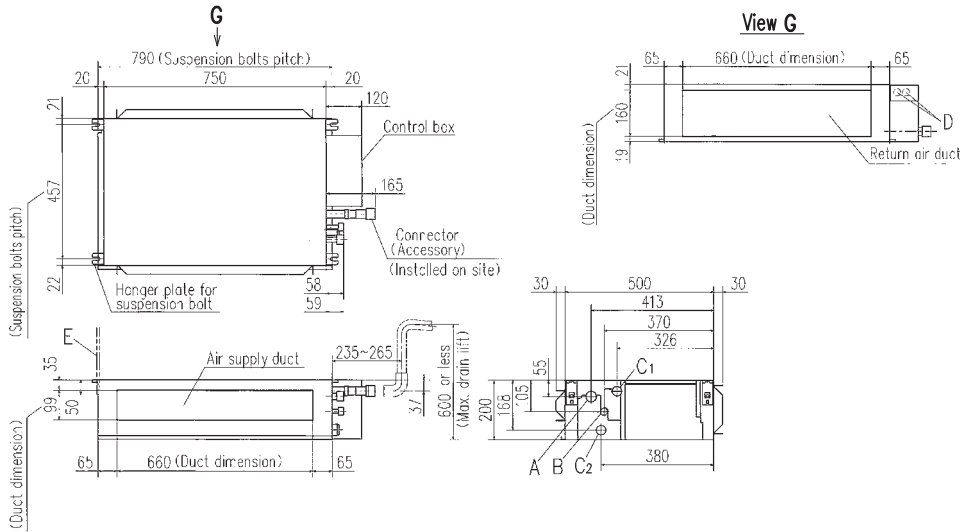

Symbol	Model	Content
A	Gas piping	φ95.2 (3.74") (Flare)
B	Drain piping	φ25 (1.02") (Flare)
C1	Drain piping	VP25 (1.0, 25, 0.3, 32) (Used with attached connector)
C2	Drain piping	VP25 (1.0, 25, 0.3, 32) (Gravily drainage) (Used with attached connector)
D	Hole for wiring	φ25 x 2
E	Suspension bolts	φ16
F	Insulation hole	φ450 (18.1) (2270 (89.3))

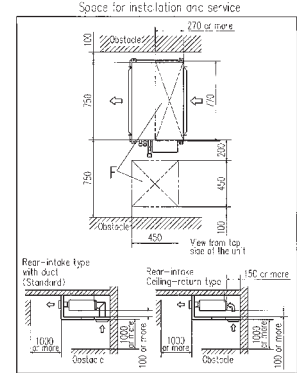

FDUT45KXE6F-E, 56KXE6F-E

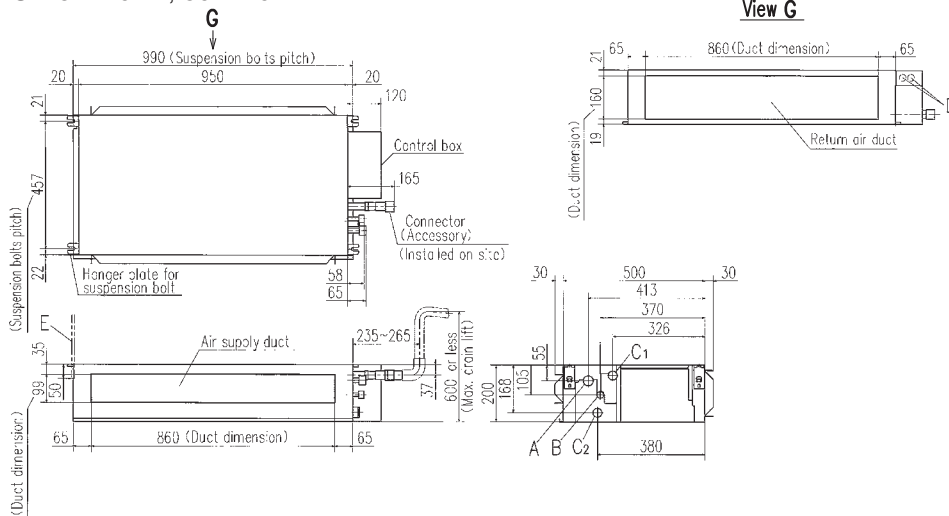

Symbol	Model	Content
A	Gas piping	φ95.2 (3.74") (Flare)
B	Drain piping	φ25 (1.02") (Flare)
C1	Drain piping	VP25 (1.0, 25, 0.3, 32) (Used with attached connector)
C2	Drain piping	VP25 (1.0, 25, 0.3, 32) (Gravily drainage) (Used with attached connector)
D	Hole for wiring	φ25 x 2
E	Suspension bolts	φ16
F	Insulation hole	φ450 (18.1) (2270 (89.3))

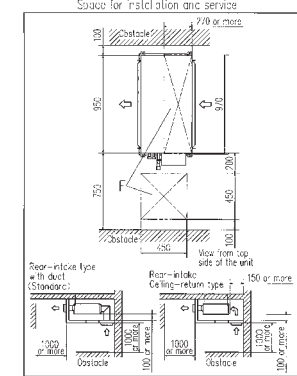

FDUT71KXE6F-E

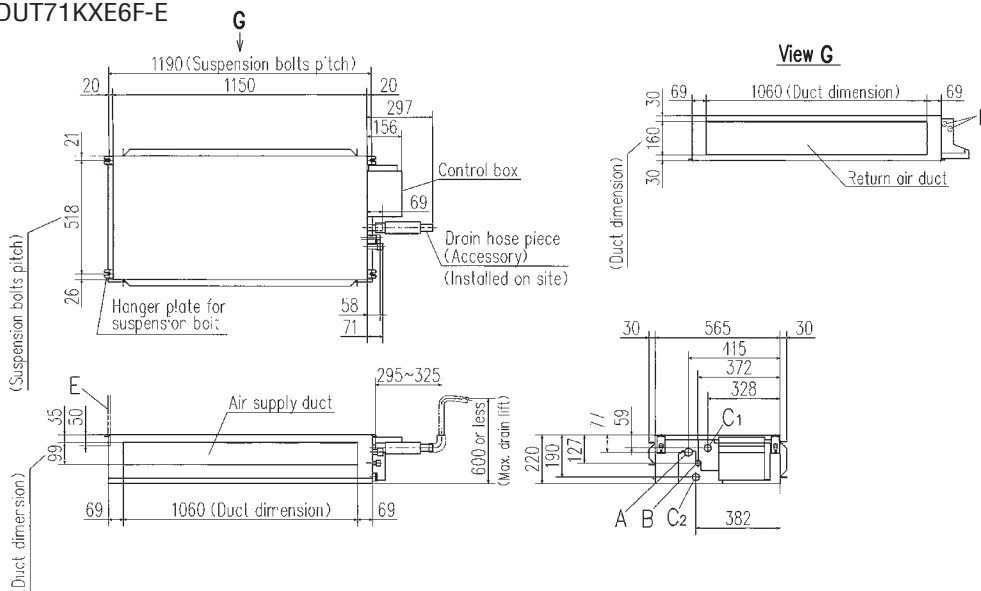

Symbol	Model	Content
A	Gas piping	φ95.2 (3.74") (Flare)
B	Drain piping	φ25 (1.02") (Flare)
C1	Drain piping	VP25 (1.0, 25, 0.3, 32) (Used with attached socket)
C2	Drain piping	VP25 (1.0, 25, 0.3, 32) (Used with attached socket)
D	Hole for wiring	φ25 x 2
E	Suspension bolts	φ16
F	Insulation hole	φ450 (18.1) (2270 (89.3))

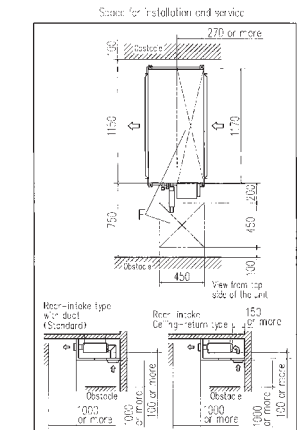



Duct Connected (Compact & Flexible) FDUH

Model No.
FDUH22KXE6F
FDUH28KXE6F
FDUH36KXE6F

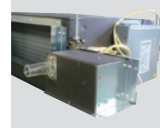

Drain up kit (option)
(600mm)
UH-DU-E

Remote control (option)

Wired



RC-EX3A RC-E5 RCH-E3

Wireless



RCN-KIT4-E2

Filter kit (option)
UH-FL1E



*Filter pressure loss:5pa

Compact and thin size, light weight

Our leading high technology has realized the best solution for air conditioning in hotels with compact and thin size units and high energy efficiency. In addition, weight is only 20kg.

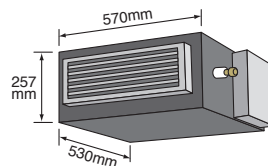

Quiet operation

The lowest sound level in the industry can ensure comfortable stay and rest in hotels.

Installation Flexibility

Control box and drain piping can be installed on both side of the unit and air intake to the unit is available from bottom or back side. Our highest technology can satisfy diverse installation requirements.

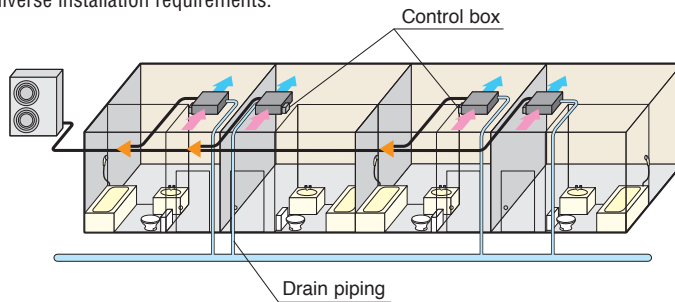

Wired remote control



RCH-E3 (option)

Simple remote control

Designed specially for hotel rooms, control buttons are limited only to the minimum required functions such as ON/OFF, mode, temperature setting and fan speed. It is really simple and easy to use.

Specifications

Item	Model	FDUH22KXE6F	FDUH28KXE6F	FDUH36KXE6F
Nominal cooling capacity	kW	2.2	2.8	3.6
Nominal heating capacity	kW	2.5	3.2	4.0
Power source		1 Phase 220-240V, 50Hz		
Power consumption	Cooling	0.05-0.07		
	Heating	0.05-0.07		
Sound power level	dB(A)	60		
Sound pressure level	dB(A)	P-Hi:39 Hi: 33 Me: 30 Lo: 27		
Exterior dimensions HxWxD	mm	257x570x530		
Net weight	kg	22		
Air flow	m ³ /min	P-Hi:8.5 Hi: 7 Me: 6.5 Lo: 6		
External static pressure	Pa	30		
Outside air intake		Possible from return duct		
Air filter		Filter kit:UH-FL1E(option)		
Remote control(option)		wired:RC-EX3A, RC-E5, RCH-E3 wireless:RCN-KIT4-E2		
Installation data	mm(m)	Liquid line:ø6.35(1/4")		Liquid line:ø6.35(1/4")
	Refrigerant piping size	Gas line:ø9.52(3/8")		Gas line:ø12.7(1/2")

1. The data are measured under the following conditions(ISO-T1). Cooling: Indoor temp. of 27°CDB, 19°CWB, and outdoor temp. of 35°CDB. Heating: Indoor temp. of 20°CDB, and outdoor temp. of 7°CDB, 6°CWB.
2. Sound pressure level indicates the value in an anechoic chamber. During operation these values are somewhat higher due to ambient conditions.

Dimensions

All measurements in mm.

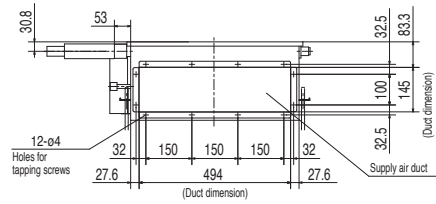

Symbol	Content		
	Model	FDUH22XE6F/28XE6F	FDUH38XE6F
A	Gas piping	ø9.52 (3/8") (Flare)	ø12.7 (1/2") (Flare)
B	Liquid piping	ø6.35 (1/4") (Flare)	
C ₁ , C ₂	Drain piping	VP20(I, D.20, O.D.26) Note (2)	
D	Hole for wiring	ø30	
E	Suspension bolts	(M10)	
F	Inspection hole	(635X890) Note (3)	

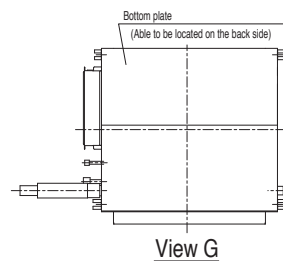
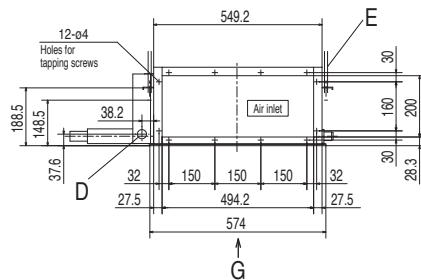
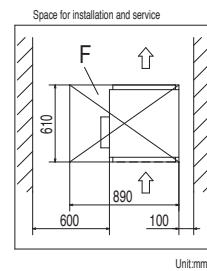
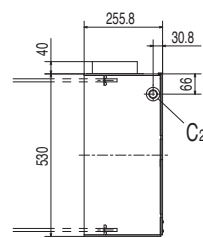
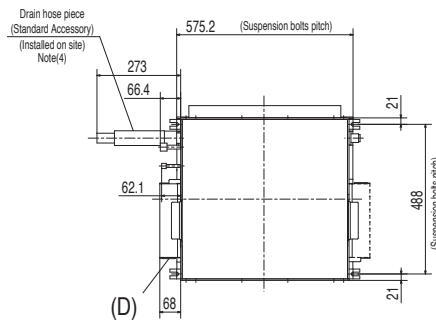
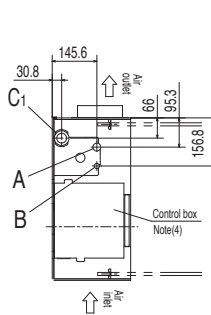

Notes

- (1) The model name label is attached on the fan case inside the air return grille.
- (2) Prepare the connecting socket (VP20) on site. (As for drain piping, it is possible to choose C₁ or C₂)
- (3) When control box is located on the reverse side, installation space should be modified to new location.
- (4) Control box and Drain hose piece are able to be relocated on the reverse side.

In case of Bottom air intake

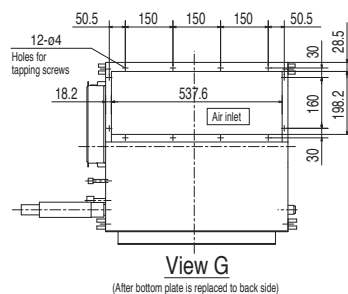

Simple remote control

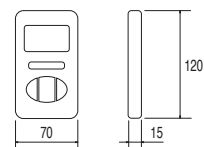



Wall Mounted FDK

- Model No.**
 FDK15KXZE1
 FDK22KXZE1
 FDK28KXZE1
 FDK36KXZE1
 FDK45KXZE1
 FDK56KXZE1
 FDK71KXZE1
 FDK90KXZE1



Remote control (option)

Wired

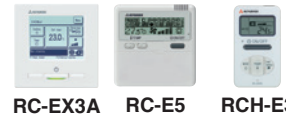

Wireless

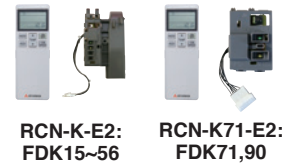

Elegant Timeless Design

The FDK series air-conditioners have been stylishly designed with rounded contours that fit beautifully into any of Europe's diverse interior settings. The design was created by the Italian industrial design studio Tensa srl, based in Milan, to respond to a broad spectrum of local user needs. (15~56KXZE1)

Flap control system

Selection of flap position is possible. A flap can be set at different angles.

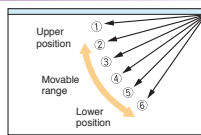

* The wireless remote control is not applicable to the flap control system.

Lateral Swing ▶ flap swings from right to left automatically

Up/Down Flap swing + Lateral swing

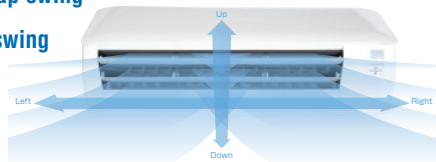

Jet Technology

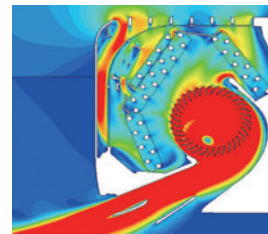

Fast ← Slow
Colours in the figure show the air speed.

FDK models adopt the air flow design that's proven to minimise resistance in a CFD analysis to achieve uniform air conditioning to the furthest corners of the room.

Motion Sensor



(Option)

Motion sensor is equipped in the ceiling plane or wall plane and detects the presence/absence and activity of humans in a room to improve the comfort and energy saving performance of the unit.



LB-KIT

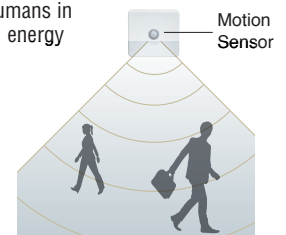

Specifications

Item	Model	FDK15KXZE1	FDK22KXZE1	FDK28KXZE1	FDK36KXZE1	FDK45KXZE1	FDK56KXZE1	FDK71KXZE1	FDK90KXZE1	
Nominal cooling capacity	kW	1.5	2.2	2.8	3.6	4.5	5.6	7.1	9.0	
Nominal heating capacity	kW	1.7	2.5	3.2	4.0	5.0	6.3	8.0	10.0	
Power source		1 Phase 220-240V, 50Hz								
Power consumption	Cooling	0.02-0.02			0.03-0.03			0.04-0.04	0.05-0.05	
	Heating	0.02-0.02			0.03-0.03			0.04-0.04	0.05-0.05	
Sound power level	dB(A)	54	55	58	58	59	61	61	61	
Sound pressure level	Cooling	P-Hi:38 Hi:34 Me:31 Lo:28	P-Hi:38 Hi:36 Me:32 Lo:28	P-Hi:40 Hi:38 Me:33 Lo:28	P-Hi:43 Hi:41 Me:36 Lo:33	P-Hi:43 Hi:41 Me:36 Lo:33	P-Hi:42 Hi:40 Me:37 Lo:35	P-Hi:44 Hi:42 Me:39 Lo:35	P-Hi:44 Hi:42 Me:39 Lo:35	
	Heating	P-Hi:38 Hi:34 Me:31 Lo:28	P-Hi:38 Hi:36 Me:32 Lo:28	P-Hi:40 Hi:38 Me:33 Lo:28	P-Hi:43 Hi:41 Me:36 Lo:33	P-Hi:44 Hi:42 Me:37 Lo:33	P-Hi:42 Hi:40 Me:37 Lo:35	P-Hi:44 Hi:42 Me:39 Lo:35	P-Hi:44 Hi:42 Me:39 Lo:35	
Exterior dimensions H x W x D	mm	290 x 870 x 230						339 x 1197 x 262		
Net weight	kg	11.5	11	11.5	11.5	11.5	17	17	17	
Air flow	Cooling	P-Hi:5.7 Hi:5 Me:4.5 Lo:3.6	P-Hi:8.5 Hi:8 Me:6 Lo:5	P-Hi:11 Hi:10 Me:8 Lo:7	P-Hi:12 Hi:11 Me:9 Lo:8	P-Hi:12 Hi:11 Me:9 Lo:8	P-Hi:13 Hi:12 Me:10 Lo:8	P-Hi:21 Hi:19 Me:16 Lo:14	P-Hi:23 Hi:21 Me:19 Lo:16	
	Heating									
Outside air intake		Not possible								
Air filter, Q'ty		Polypropylene net x2 (Washable)								
Remote control(option)		wired:RC-EX3A, RC-E5, RCH-E3 wireless:RCN-K-E2, RCN-K71-E2								
Installation data Refrigerant piping size	mm(in)	Liquid line:ø6.35(1/4") Gas line:ø9.52(3/8")			Liquid line:ø6.35(1/4") Gas line:ø12.7(1/2")			Liquid line:ø9.52(3/8") Gas line:ø15.88(5/8")		

1. The data are measured under the following conditions(ISO-T1). Cooling: Indoor temp. of 27°CDB, 19°CWB, and outdoor temp. of 35°CDB. Heating: Indoor temp. of 20°CDB, and outdoor temp. of 7°CDB, 6°CWB.
 2. Sound pressure level indicates the value in an anechoic chamber. During operation these values are somewhat higher due to ambient conditions.

Dimensions

All measurements in mm.

FDK15KXE1, 22KXE1, 28KXE1, 36KXE1, 45KXE1, 56KXE1

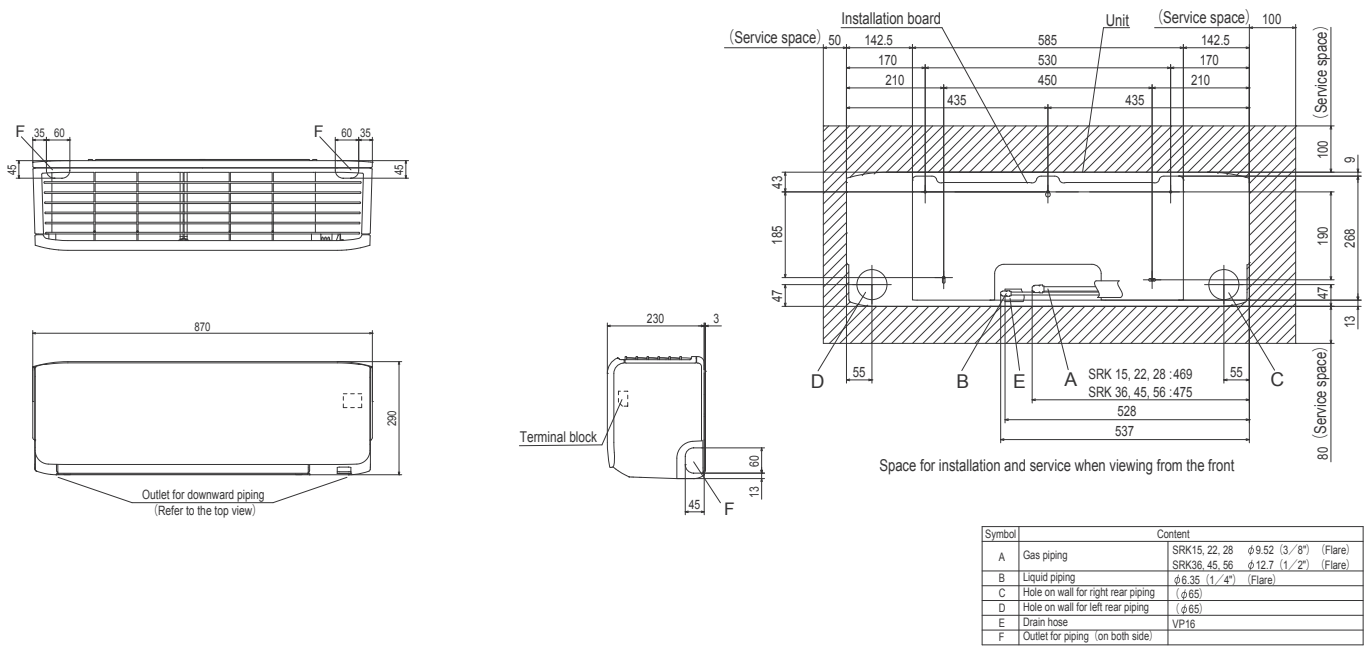

FDK71KXE1, 90KXE1

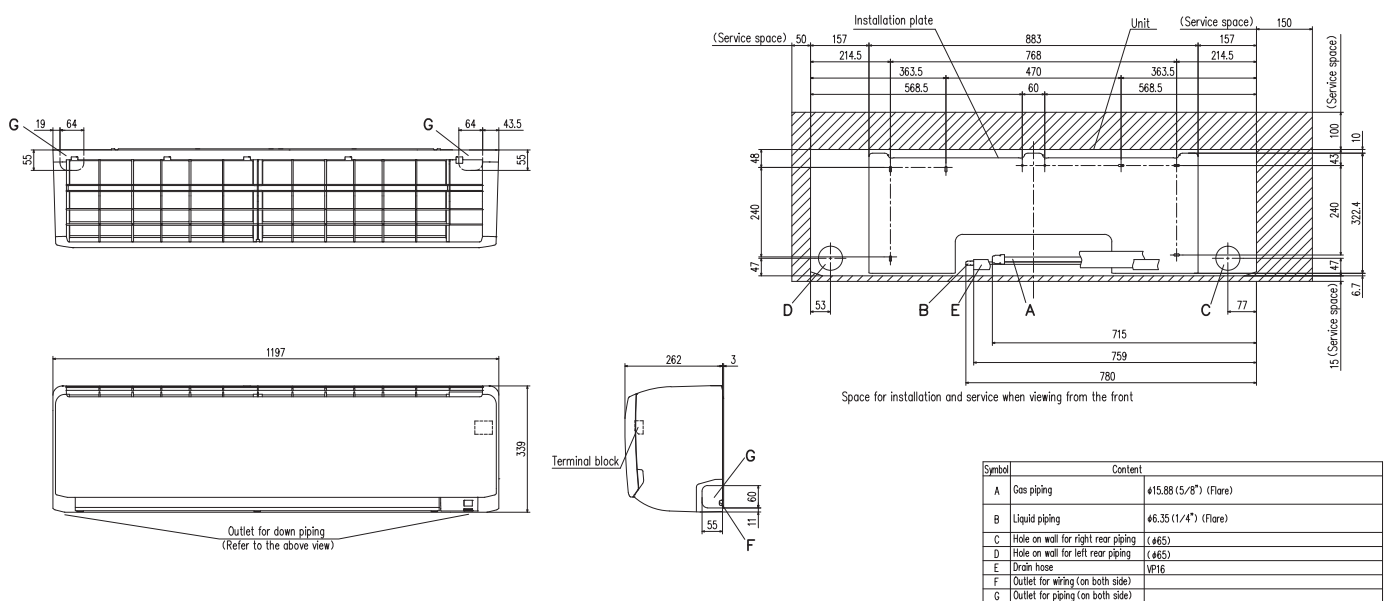



Ceiling Suspended FDE

- Model No.**
 FDE36KXZE1
 FDE45KXZE1
 FDE56KXZE1
 FDE71KXZE1
 FDE112KXZE1
 FDE140KXZE1



Remote control (option)

Wired



RC-EX3A RC-E5 RCH-E3

Wireless



RCN-E-E2

Flap control system

Selection of flap position is possible. A flap can be set at different angles.

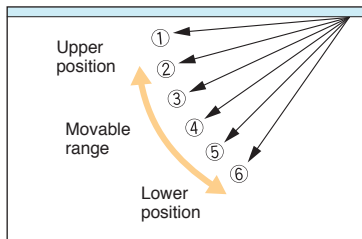

*The wireless remote control is not applicable to the flap control system.

Reduction of weight

Thanks to decreasing the numbers of fan motor from two to one, reduction of weight was achieved.

	Previous		Current	
FDE71	37	➔	33	4kg less!!
FDE112	49	➔	43	6kg less!!
FDE140	49	➔	43	6kg less!!

Reduction of sound pressure level (Lo mode)

The industry's lowest sound pressure levels were achieved by decreasing air flow volume, decreasing pressure loss with employment of one fan motor and optimizing casing and distributor shape. (comparison of previous model)

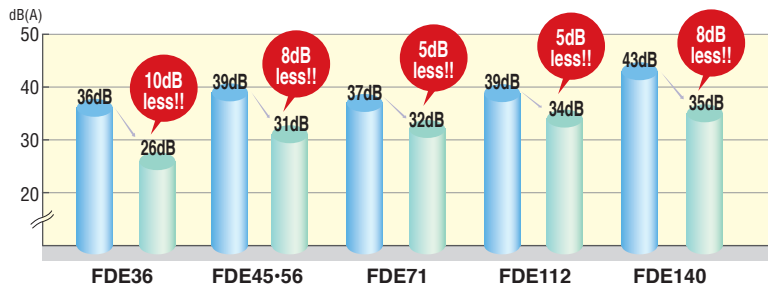

Motion Sensor



(Option)

Motion sensor is equipped in the panel and detects the presence/absence and activity of humans in a room to improve the comfort and energy saving performance of the unit.



LB-E

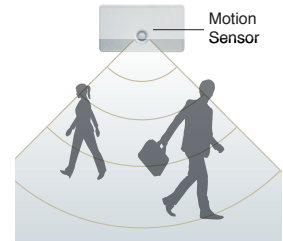

Specifications

Item	Model	FDE36KXZE1	FDE45KXZE1	FDE56KXZE1	FDE71KXZE1	FDE112KXZE1	FDE140KXZE1
Nominal cooling capacity	kW	3.6	4.5	5.6	7.1	11.2	14.0
Nominal heating capacity	kW	4.0	5.0	6.3	8.0	12.5	16.0
Power source		1 Phase 220-240V, 50Hz					
Power consumption	Cooling	0.05-0.05			0.07-0.07	0.10-0.10	0.13-0.13
	Heating	0.05-0.05			0.07-0.07	0.10-0.10	0.13-0.13
Sound power level	dB(A)	60					
Sound pressure level	dB(A)	P-Hi:46 Hi:38 Me:31 Lo:26	P-Hi:46 Hi:38 Me:36 Lo:31	P-Hi:46 Hi:38 Me:36 Lo:31	P-Hi:47 Hi:39 Me:37 Lo:32	P-Hi:45 Hi:42 Me:38 Lo:34	P-Hi:48 Hi:43 Me:40 Lo:35
Exterior dimensions H x W x D	mm	210 x 1070 x 690			210 x 1320 x 690	250 x 1620 x 690	
Net weight	kg	28			33	43	
Air flow	m ³ /min	P-Hi:13 Hi:10 Me:7 Lo:5.5	P-Hi:13 Hi:10 Me:9 Lo:7		P-Hi:20 Hi:15 Me:13 Lo:10	P-Hi:28 Hi:25 Me:21 Lo:16.5	P-Hi:32 Hi:26 Me:23 Lo:17
Outside air intake		Not possible					
Air filter, Q'ty		Pocket Plastic net x2 (Washable)					
Remote control(option)		wired:RC-EX3A, RC-E5, RCH-E3 wireless:RCN-E-E3					
Installation data Refrigerant piping size	mm(in)	Liquid line:ø6.35(1/4") Gas line:ø12.7(1/2")			Liquid line:ø9.52(3/8") Gas line:ø15.88(5/8")		

1. The data are measured under the following conditions(ISO-T1). Cooling: Indoor temp. of 27°CDB, 19°CWB, and outdoor temp. of 35°CDB. Heating: Indoor temp. of 20°CDB, and outdoor temp. of 7°CDB, 6°CWB.
 2. Sound pressure level indicates the value in an anechoic chamber. During operation these values are somewhat higher due to ambient conditions.

Dimensions

All measurements in mm.

FDE36KXZE1, 45KXZE1, 56KXZE1

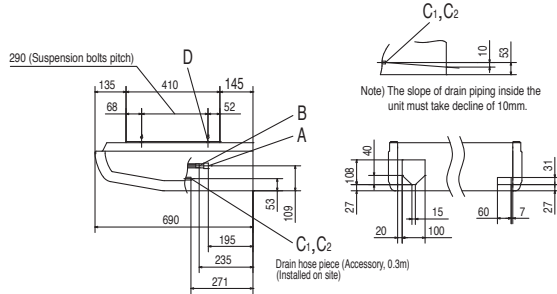
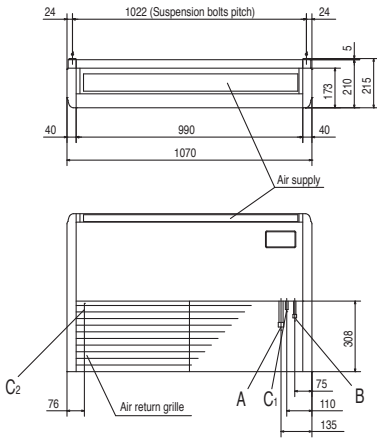

Symbol	Content
A	Gas piping ø12.7 (1/2") (Flare)
B	Liquid piping ø6.35 (1/4") (Flare)
C _{1,2}	Drain piping VP20 (I.D.20)
D	Hole for suspension bolt (M10 or M8)
E	Back cutout PE cover
F	Top cutout Plate cover
G	Hole for drain piping (for left back) (Knock out)

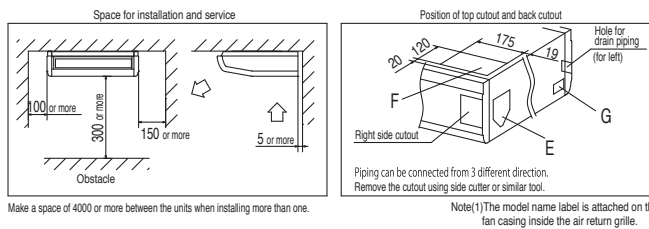

Make a space of 4000 or more between the units when installing more than one.

Note(1) The model name label is attached on the fan casing inside the air return grille.

FDE71KXZE1

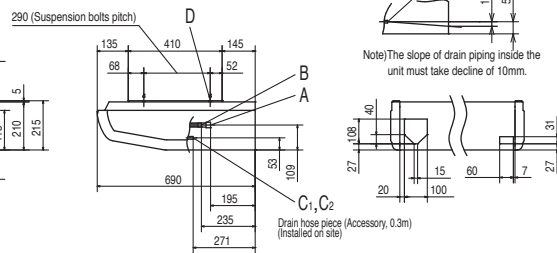
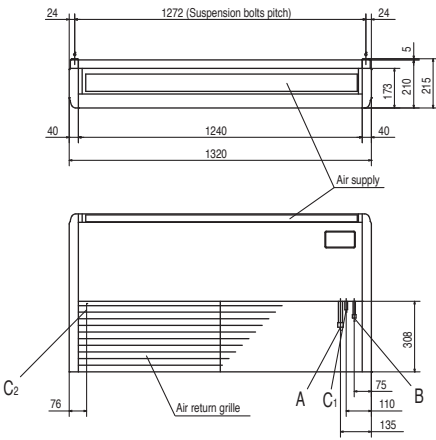

Symbol	Content
A	Gas piping ø15.88 (5/8") (Flare)
B	Liquid piping ø9.52 (3/8") (Flare)
C _{1,2}	Drain piping VP20 (I.D.20)
D	Hole for suspension bolt (M10 or M8)
E	Back cutout PE cover
F	Top cutout Plate cover
G	Hole for drain piping (for left back) (Knock out)

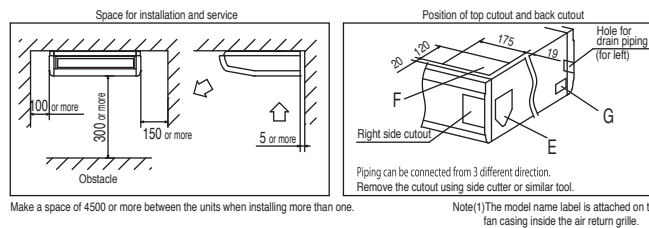

Make a space of 4500 or more between the units when installing more than one.

Note(1) The model name label is attached on the fan casing inside the air return grille.

FDE112KXZE1, 140KXZE1

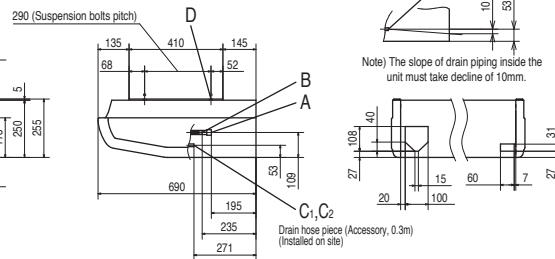
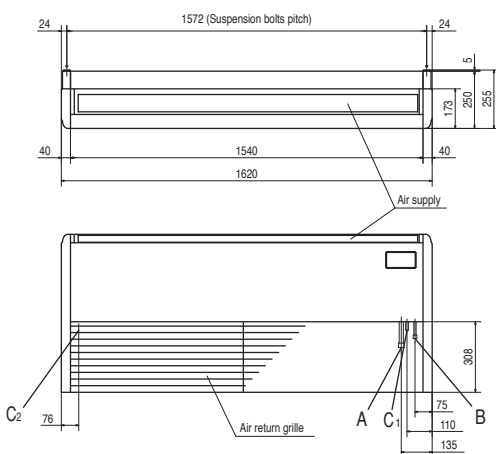

Symbol	Content
A	Gas piping ø15.88 (5/8") (Flare)
B	Liquid piping ø9.52 (3/8") (Flare)
C _{1,2}	Drain piping VP20 (I.D.20)
D	Hole for suspension bolt (M10 or M8)
E	Back cutout PE cover
F	Top cutout Plate cover
G	Hole for drain piping (for left back) (Knock out)

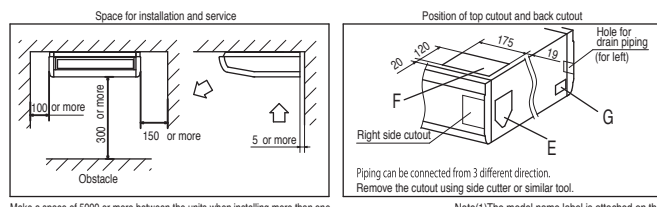

Make a space of 5000 or more between the units when installing more than one.

Note(1) The model name label is attached on the fan casing inside the air return grille.



Floor Standing -2way- FDFW

Model No.

FDFW28KXE6F
FDFW45KXE6F
FDFW56KXE6F



Auto air outlet selection



Remote control (option)

Wired



RC-EX3A RC-E5 RCH-E3

Wireless



RCN-FW-E2

Sophisticated Design

With an elegant semi flat front panel in stylish white, the new series fit in various kinds of rooms and create relaxing atmosphere. Choice of wall hanging, floor standing or behind gallery installation is available.

Quiet Operation

Thanks to optimum balance of air outlet direction and sufficient air flow volume, the sound level has been minimized. The level of FDFW28KXE6F in the cooling lo mode is 30dB(A) only.

Flap control system

Selection of flap position is possible. A flap can be set at different angles.

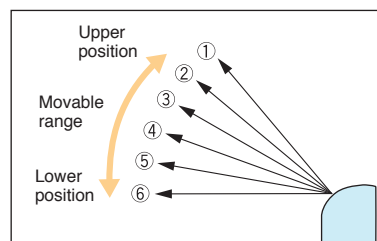

*The wireless remote control is not applicable to the flap control system.

Convenient to use operation

Simultaneous lower and upper air outlets or upper outlet can be selected by air flow direction button. Further control can be arranged by a remote control.

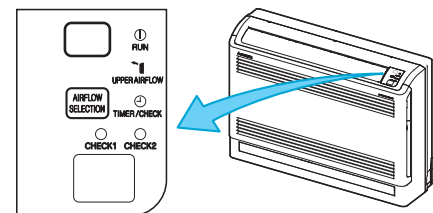

(In case of use of wireless remote control)

Specifications

Item	Model	FDFW28KXE6F	FDFW45KXE6F	FDFW56KXE6F
Nominal cooling capacity	kW	2.8	4.5	5.6
Nominal heating capacity	kW	3.2	5.0	6.3
Power source		1 Phase 220-240V, 50Hz		
Power consumption	Cooling	0.02-0.02	0.02-0.02	0.03-0.03
	Heating	0.02-0.02	0.02-0.02	0.03-0.03
Sound power level	dB(A)	55	57	60
Sound pressure level	dB(A)	Hi:36 Me:34 Lo:30	Hi:38 Me:36 Lo:33	Hi:44 Me:37 Lo:33
Exterior dimensions H x W x D	mm	600x860x238		
Net weight	kg	19	20	20
Air flow (Standard)	m ³ /min	Hi:9 Me:8 Lo:7		Hi:11 Me:9 Lo:8
Air filter, Q'ty		Polypropylene net x1 (Washable)		
Remote control(option)		wired:RC-EX3A, RC-E5, RCH-E3 wireless:RCN-FW-E2		
Installation data Refrigerant piping size	mm(in)	Liquid line:ø6.35(1/4") Gas line:ø9.52(3/8")		Liquid line:ø6.35(1/4") Gas line:ø12.7(1/2")

1. The data are measured under the following conditions(ISO-T1). Cooling: Indoor temp. of 27°CDB, 19°CWB, and outdoor temp. of 35°CDB. Heating: Indoor temp. of 20°CDB, and outdoor temp. of 7°CDB, 6°CWB.
2. Sound pressure level indicates the value in an anechoic chamber. During operation these values are somewhat higher due to ambient conditions.

Dimensions

All measurements in mm.

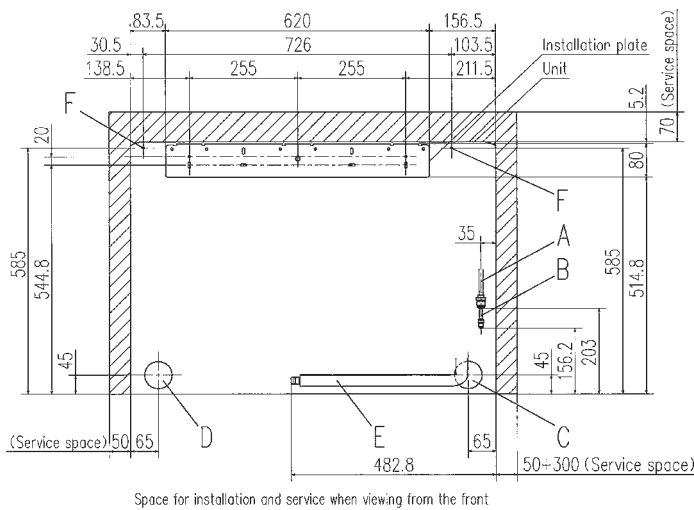
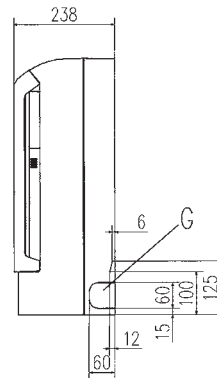
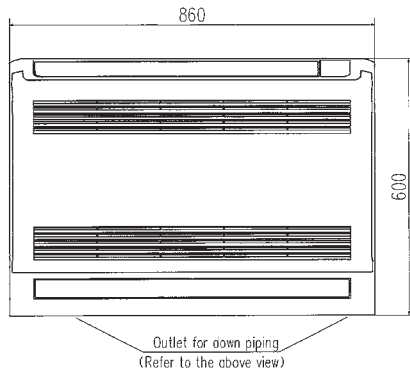
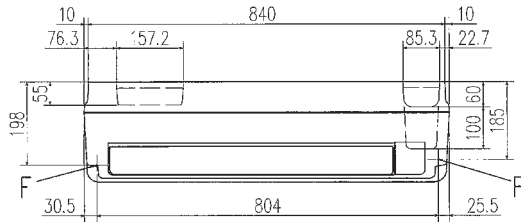

Space for installation and service when viewing from the front

Symbol	Content	
	Model	
A	Gas piping	FDFW28KXE6F $\phi 9.52 (3/8")$ (Flare) FDFW45KXE6F, 56KXE6F $\phi 12.7 (1/2")$ (Flare)
B	Liquid piping	$\phi 6.35 (1/4")$ (Flare)
C	Hole on wall for right rear piping	$\phi 65$
D	Hole on wall for left rear piping	$\phi 65$
E	Drain hose	VP16 (I.D.16)
F	Screw point, fasten the indoor unit	$\phi 5$
G	Outlet for piping (on both side)	

Notes

- (1) The model name label is attached on the right side of the unit.
- (2) In case of wall installation, leave the unit 150mm or less from the floor.



Floor Standing (with casing) FDFL

Floor Standing (without casing) FDFU

Remote control (option)

Wired



RC-EX3A



RC-E5



RCH-E3

Wireless



RCN-KIT4-E2



Model No.

FDFL71KXE6F

FDFU28KXE6F

FDFU45KXE6F

FDFU56KXE6F

FDFU71KXE6F



FDFL

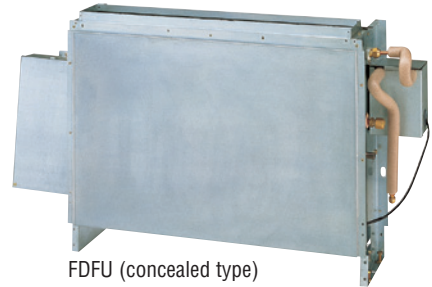

FDFU (concealed type)



Compact design at 630mm height

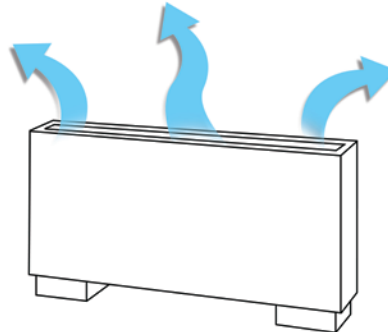

Wider airflow for optimum comfort

Specifications

Item	Model	FDFL71KXE6F	FDFU28KXE6F	FDFU45KXE6F	FDFU56KXE6F	FDFU71KXE6F
Nominal cooling capacity	kW	7.1	2.8	4.5	5.6	7.1
Nominal heating capacity	kW	8.0	3.2	5.0	6.3	8.0
Power source		1 Phase 220-240V, 50Hz				
Power consumption	Cooling	0.09-0.10		0.09-0.10		
	Heating	0.09-0.10		0.09-0.10		
Sound power level	dB(A)	62	58	60		
Sound pressure level	dB(A)	Hi:43 Me:41 Lo:40	Hi:41 Me:38 Lo:36	Hi:43 Me:41 Lo:40		
Exterior dimensions H x W x D	mm	630x1481x225	630x1077x225			630x1362x225
Net weight	kg	40	25			32
Air flow (Standard)	m ³ /min	Hi:18 Me:15 Lo:12	Hi:12 Me:11 Lo:10	Hi:14 Me:12 Lo:10		Hi:18 Me:15 Lo:12
Air filter, Q'ty		Polypropylene net x1 (Washable)				
Remote control(option)		wired:RC-EX3A, RC-E5, RCH-E3 wireless:RCN-KIT4-E2				
Installation data Refrigerant piping size	mm(in)	Liquid line:ø9.52(3/8")	Liquid line:ø6.35(1/4")	Liquid line:ø6.35(1/4")		Liquid line:ø9.52(3/8")
		Gas line:ø15.88(5/8")	Gas line:ø9.52(3/8")	Gas line:ø12.7(1/2")		Gas line:ø15.88(5/8")

1. The data are measured under the following conditions(ISO-T1). Cooling: Indoor temp. of 27°CDB, 19°CWB, and outdoor temp. of 35°CDB. Heating: Indoor temp. of 20°CDB, and outdoor temp. of 7°CDB, 6°CWB.
2. Sound pressure level indicates the value in an anechoic chamber. During operation these values are somewhat higher due to ambient conditions.

Dimensions

All measurements in mm.

FDFL

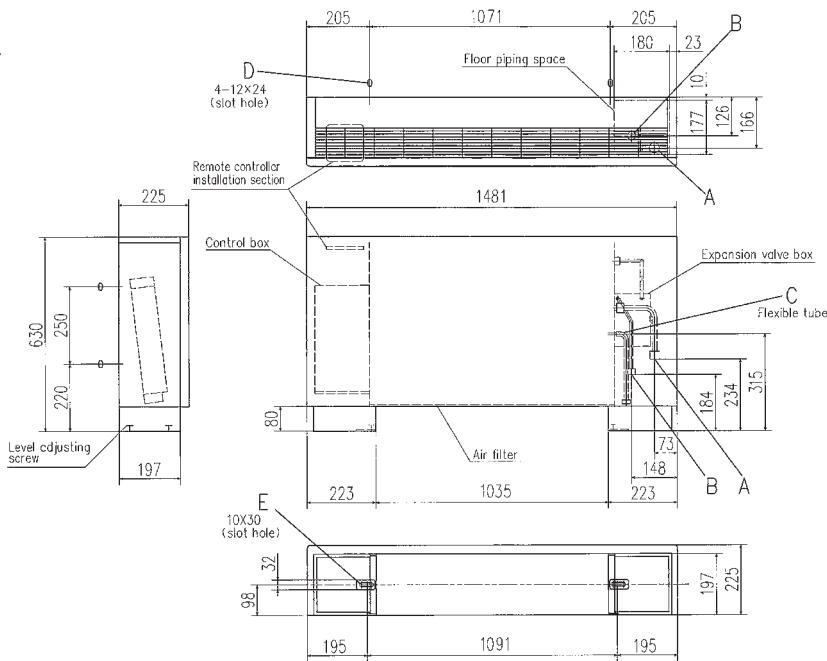

Symbol	Model	Content
		FDFL71KXE6F
A	Gas piping (Accessory)	φ15.88 (5/8") (Flare)
B	Liquid piping	φ9.52 (3/8") (Flare)
C	Drain piping (Accessory)	PT20A female screw, 360mm
D	Slot hole for wall mounting	(M10)
E	Metal plate for floor mounting (Accessory)	(M8)

Note (1) The model name label is attached on the lid of the control box.

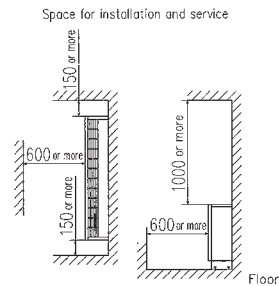

FDFU

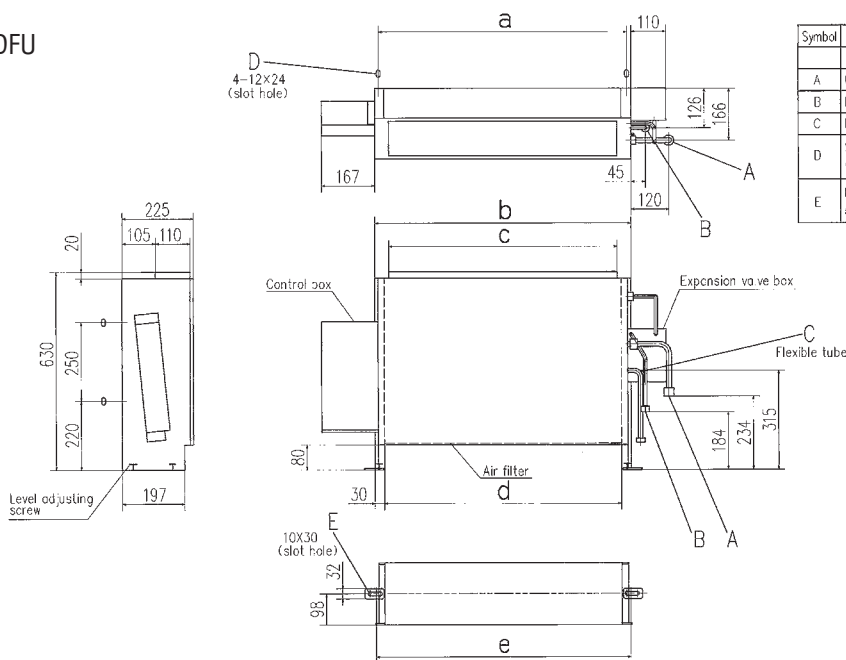

Symbol	Model	Content	Content	Content
		FDFU28KXE6F	FDFU45KXE6F, 56KXE6F	FDFU71KXE6F
A	Gas piping (Accessory)	φ9.52 (3/8") (Flare)	φ12.7 (1/2") (Flare)	φ15.88 (5/8") (Flare)
B	Liquid piping	φ6.35 (1/4") (Flare)		φ9.52 (3/8") (Flare)
C	Drain piping (Accessory)	PT20A female screw, 360mm		PT20A female screw, 360mm
D	Slot hole for wall mounting	(M10)	(M10)	(M10)
E	Metal plate for floor mounting (Accessory)	(M8)	(M8)	(M8)

Note (1) The model name label is attached on the lid of the control box.

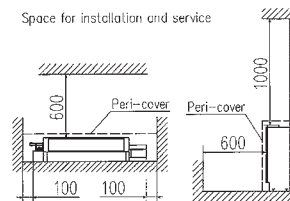

Dimension Table

Unit:mm

model	a	b	c	d	e
FDFU28KXE6F, 45KXE6F, 56KXE6F	786	810	722	750	806
FDFU71KXE6F	1071	1095	1007	1035	1091



Outdoor Air Processing unit FDU-F

Model No.

FDU650FKXZE1
FDU1100FKXZE1
FDU1800FKXZE1
FDU2400FKXZE1



Remote control (option)

Wired



RC-EX3A RC-E5 RCH-E3

Wireless



RCN-KIT4-E2

Air conditioning and intake of outdoor air are in the same system

Outdoor Air processing unit can be connected in a KXZ system as one of the indoor unit series and can create fresh and comfortable air supply together from our high advanced technology.

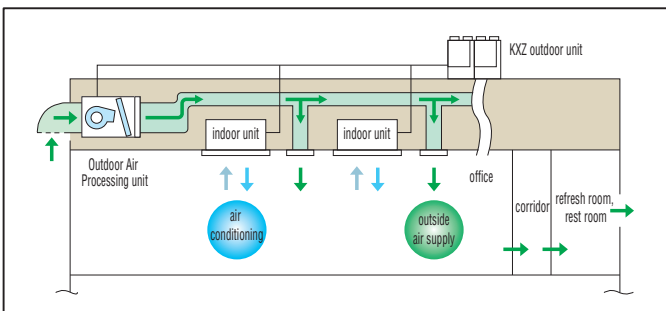

Motion Sensor



(Option)

Motion sensor is equipped in the ceiling plane or wall plane and detects the presence/absence and activity of humans in a room to improve the comfort and energy saving performance of the unit.



LB-KIT

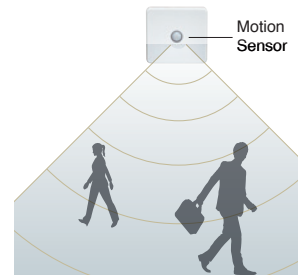

Compact design

Compact design at just 280(650, 1100), 379(1800, 2400)mm in height, high static pressure of 200Pa and the industry's lowest noise level can meet various kind of installation location for office, refresh room, restroom and kitchen of restaurant etc.

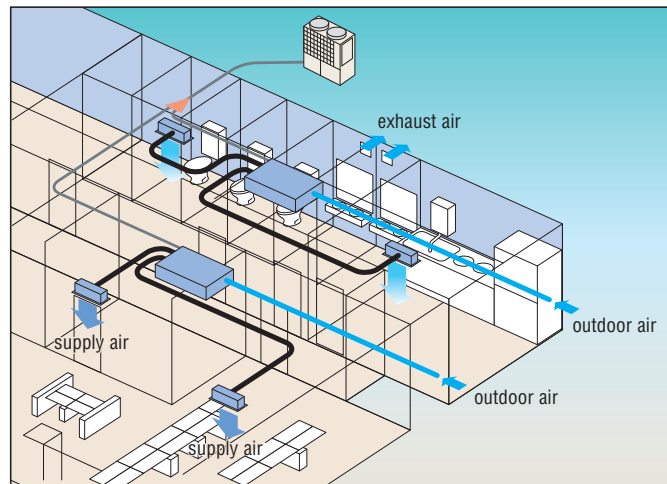

- (1) This unit is the specific unit for processing the outdoor air temperature closer to the room temperature. For conditioning the room temperature a dedicated air-conditioner is required additionally.
- (2) This unit monitors the outdoor air temperature and controls thermostat ON/OFF at the setting temperature by the remote controller, which indicates the outdoor air temperature for controlling thermostat ON/OFF. When thermostat is turned OFF, the operation is changed to the fan mode so that unprocessed outdoor air will be blown into the room directly. Therefore place the air outlet port or orient the air outlet direction not to blow air directly to persons in the room, especially in the small room such as a restroom and/or sanitary hot water supplying room.
- (3) It is strictly prohibited to monitor the room temperature by switching to the thermistor at remote controller side and/or the optional remote thermistor. Otherwise dew formation at air outlet port and/or dew dripping may occur during cooling operation due to the lower outdoor air temperature. Therefore keep the remote controller of this unit in place closer to the administrator so as not to be touched it freely by the end user.
- (4) Dehumidifying operation with this unit is prohibited.
- (5) When handing over this unit to the end user, make sure to explain sufficiently about the foregoing cautions, the installation place and usage of remote control for this unit and the location of the air outlet.

Connectivity with Outdoor units

FDU-F series are connectable to 8-60HP outdoor units, not connectable to 4-6HP, KXZ Lite.

Combination with Outdoor units

	case	Combination
A	In case OA processing units only are connected with outdoor units.	The total capacity of FDU-F is 50~100% of outdoor capacity and max quantity of FDU-F is 2 units.
B	In case both of OA processing units and dedicated air-conditioner are connected with outdoor units.	The total capacity of FDU-F and dedicated air-conditioners is 50~100% of outdoor capacity and max quantity of FDU-F should be below 30% of outdoor unit capacity.

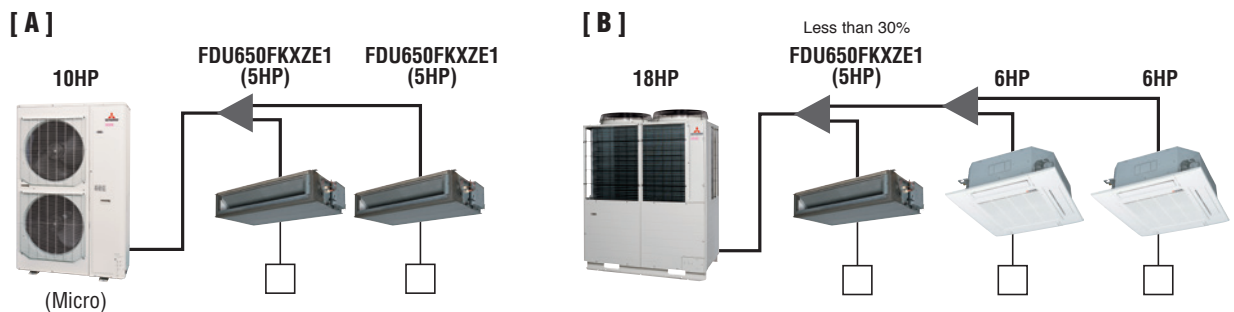

Concept (Difference between FDU-F and SAF)

SAF is the energy recovery ventilation unit which can recover heat energy from exhaust air to supply air and "has no air processing function, but FDU-F is air processing unit which can treat the supply air closer to room temperature by cooling or heating in connection with KXZ refrigerant system and exhaust air is discharged to outside of the room.

FDU-F OA Processing units

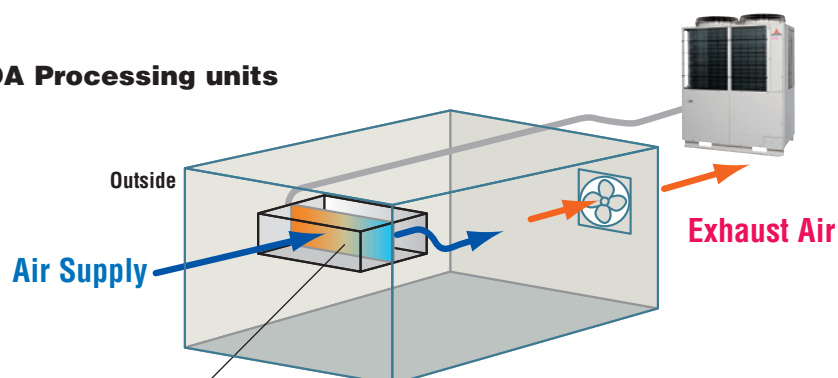

SAF

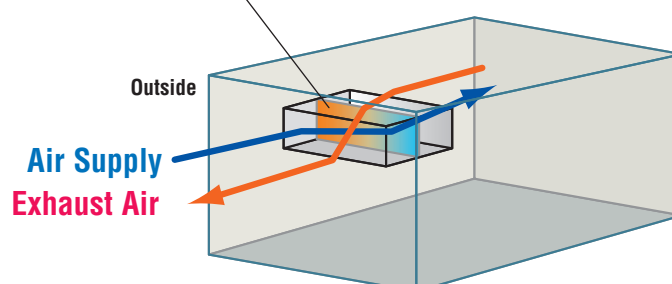



Specifications

Item	Model	FDU650FKXZE1	FDU1100FKXZE1	FDU1800FKXZE1	FDU2400FKXZE1
Nominal cooling capacity	kW	9.0	14.0	22.4	28.0
Nominal heating capacity	kW	6.5	10.5	16.0	21.5
Power source		1 Phase 220-240V, 50Hz			
Power consumption	Cooling	0.24-0.25	0.35-0.36	1.16-1.20	1.16-1.20
	Heating	0.24-0.25	0.35-0.36	1.16-1.20	1.16-1.20
Sound pressure level	dB(A)	Hi:31	Hi:37	Hi:42	Hi:45
Exterior dimension HxWxD	mm	280x950x635	280x1370x740	379x1600x893	
Net weight	kg	34	54	89	89
Air flow (Standard)	m ³ /min	Hi:11	Hi:18	Hi:30	Hi:40
External static pressure	Pa	200 (at Hi Air flow)			
Air filter, Q'ty		Procure locally			
Remote control(option)		wired:RC-EX3A, RC-E5, RCH-E3 wireless:RCN-KIT4-E2			
Installation data	mm	Liquid line:ø9.52(3/8") Gas line:ø15.88(5/8")		Liquid line:ø9.52(3/8") Gas line:ø19.05(3/4")	
Refrigerating piping size	(in)			Liquid line:ø9.52(3/8") Gas line:ø22.22(7/8")	

- The data are measured at 33°CDB 28°CWB (68%RH) during cooling and 0°CDB-2.9°CWB (50%RH) during heating (no frost).
- Temperature range of outdoor air must be 20~40°CDB (32°CWB) during cooling and 0~24°CDB during heating.
- Sound level indicates the value in an anechoic chamber. During operation these value are somewhat higher due to ambient conditions.
- The factory E.S.P. setting is set within the range of 10 - 120Pa.If SW8-4 is turned to "ON", E.S.P. setting range can be changed to 10 - 200 Pa. (with RC-EX3A and RC-E5 only)

Dimensions

All measurements in mm.

FDU650FKXZE1

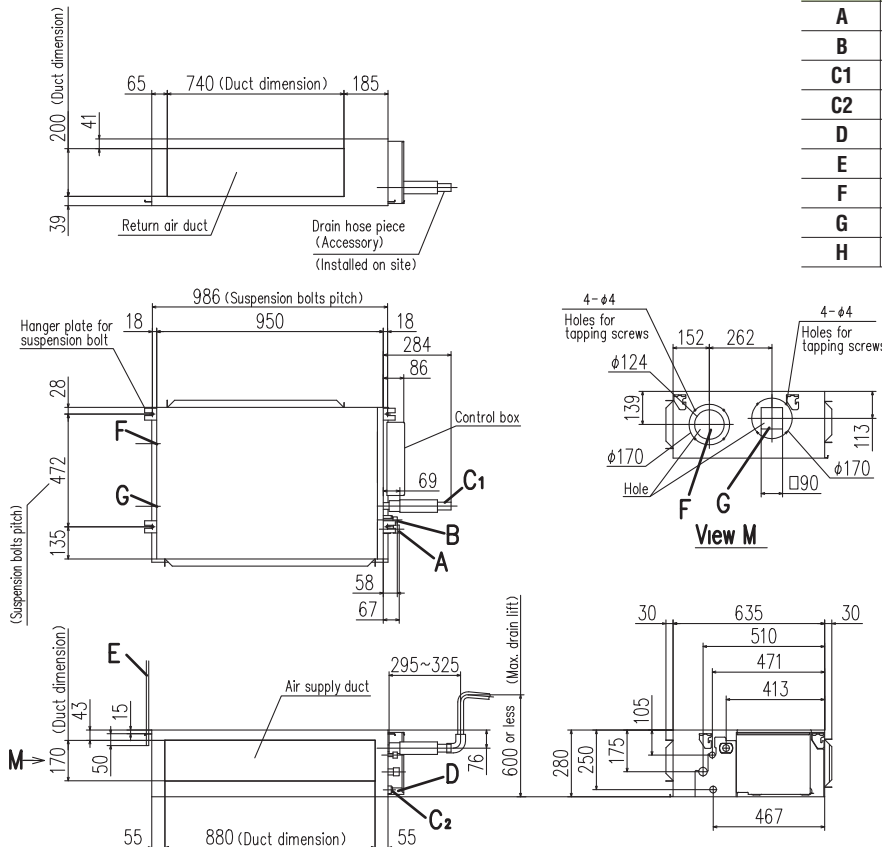

Symbol	Content	
A	Gas piping	ø15.88 (5/8") (Flare)
B	Liquid piping	ø9.52 (3/8") (Flare)
C1	Drain piping	VP25(O.D.32)
C2	Drain piping(Gravity drainage)	V20(O.D.26)
D	Hole for wiring	
E	Suspension bolts	M10
F	Outside air opening for ducting	(Knock out)
G	Air outlet opening for ducting	(Knock out)
H	Inspection opening	(450X450)

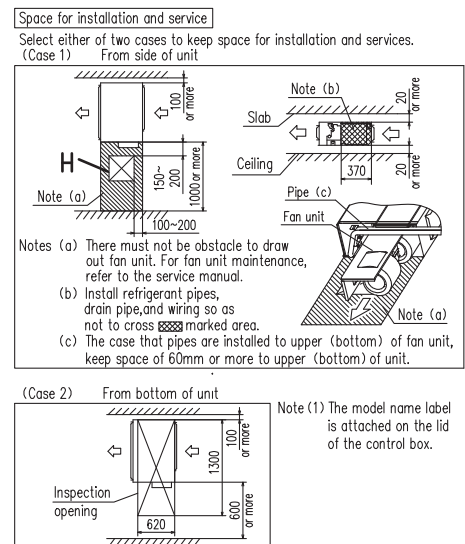

FDU1100FKXZE1

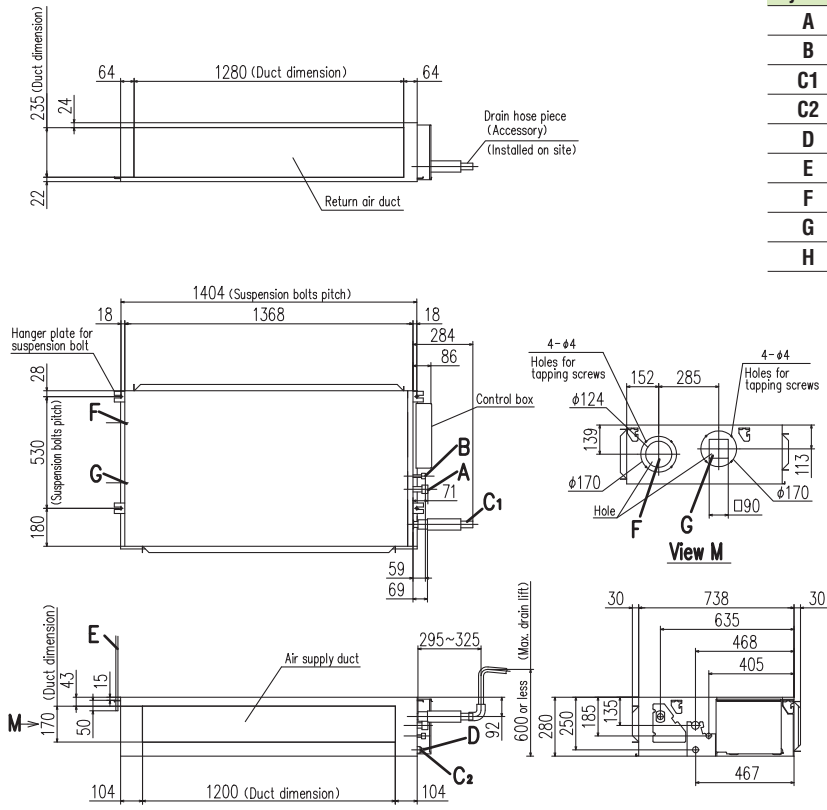

Symbol	Content	
A	Gas piping	ø15.88 (5/8") (Flare)
B	Liquid piping	ø9.52 (3/8") (Flare)
C1	Drain piping	VP25(O.D.32)
C2	Drain piping(Gravity drainage)	V20(O.D.26)
D	Hole for wiring	
E	Suspension bolts	M10
F	Outside air opening for ducting	(Knock out)
G	Air outlet opening for ducting	(Knock out)
H	Inspection opening	(450X450)

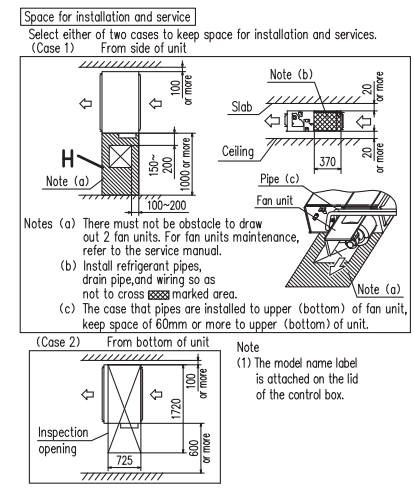

FDU1800FKXZE1, FDU2400FKXZE1

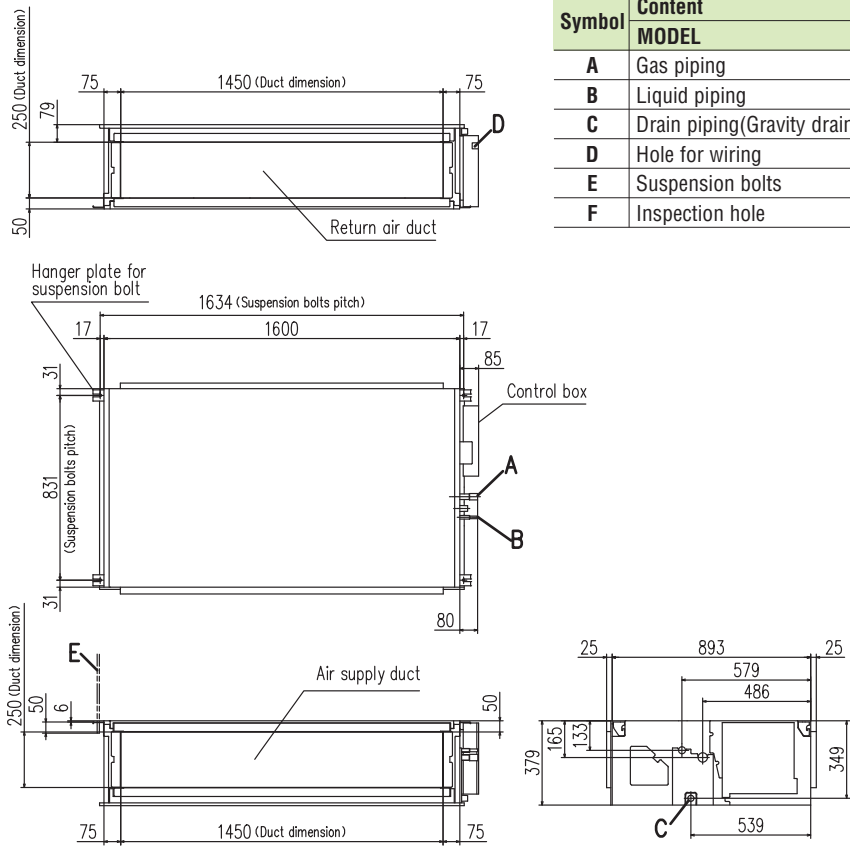

Symbol	Content	1800	2400
A	Gas piping	ø19.05 (3/4")	ø22.22 (7/8")
B	Liquid piping	ø9.52 (3/8") (Brazing)	
C	Drain piping(Gravity drainage)	VP25(O.D.32)	
D	Hole for wiring		
E	Suspension bolts	M10	
F	Inspection hole	(450X450)	

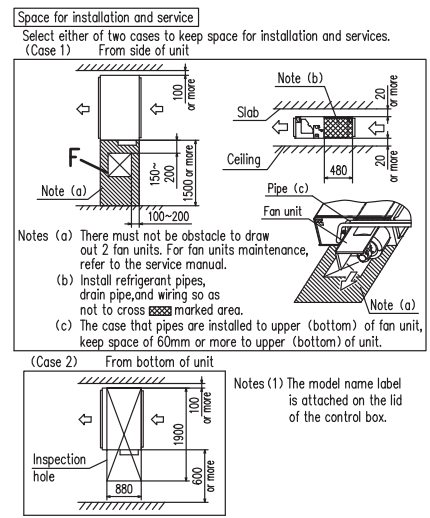



Fresh Air Ventilation and Heat Exchange unit SAF-E7

Model No.

- SAF150E7
- SAF250E7
- SAF350E7
- SAF500E7
- SAF800E7
- SAF1000E7



Energy Performance of Building Directive - EPBD

EPBD limit the amount of electrical/gas power to be used to provide heating or cooling in commercial buildings. Therefore the building designer needs to select energy efficient heating/cooling equipment, and to minimise energy losses through ventilation systems.

The SAF recovers heat energy which would otherwise be exhausted to atmosphere, and uses this energy to warm the air entering the building. The reverse happens in warmer climates, where the exhausted cool air is used to partially cool the incoming air.

Capturing this waste energy, means the heating/ cooling requirements of the building are reduced, so smaller size plant can be selected, savings can be made in long term energy consumption, and carbon emissions are reduced.

Increased external static pressure at UHi air flow

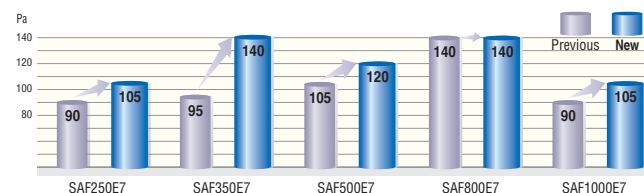

Switch box (option)



Remote control

The following functions are newly available.

- ON/OFF Timer – The hour and minute of timer on/off can be set.
- Filter Sign – Announces the due time for cleaning the air filter.

Specifications

Item	Model	SAF150E7	SAF250E7	SAF350E7	SAF500E7	SAF800E7	SAF1000E7		
Power source		1 Phase 220-240V, 50Hz							
Exterior dimensions Height x Width x Depth	mm	270x970x467	270x882x599	317x1050x804	317x1090x904	388x1322x884	388x1322x1134		
Exterior appearance		Galvanized steel sheet							
Power input	W	92-107	108-123	178-185	204-225	360-378	416-432		
Running current	A	0.42-0.45	0.49-0.51	0.81-0.77	0.93-0.94	1.64-1.58	1.89-1.80		
Capacity	UHi	Enthalpy exchange efficiency	Cooling	63	63	66	62	65	65
			Heating	70	70	69	67	71	71
		Temperature exchange efficiency	75						
	Hi	Enthalpy exchange efficiency	Cooling	63	63	66	62	65	65
			Heating	70	70	69	67	71	71
		Temperature exchange efficiency	75						
	Lo	Enthalpy exchange efficiency	Cooling	66	65	71	64	68	70
			Heating	73	72	73	69	74	76
		Temperature exchange efficiency	77	77	78	76	76	79	
Motor & Q'ty	W	10 x 2	20 x 2	40 x 2	70 x 2	180 x 2	180 x 2		
Air handling equipment Fan type & Q'ty		Sirocco fan x 2							
Air flow	UHi	150	250	350	500	800	1000		
	Hi	150	250	350	500	800	1000		
	Lo	120	190	240	440	630	700		
External static pressure	UHi	80	105	140	120	140	105		
	Hi	70	95	60	60	110	80		
	Lo	25	45	45	35	55	75		
Net weight	kg	25	29	49	57	71	83		
Remote control		Included							
Air filter	Supply air Exhaust air	Protection for element (Washable) PS400							

Structure (SAF800E7)

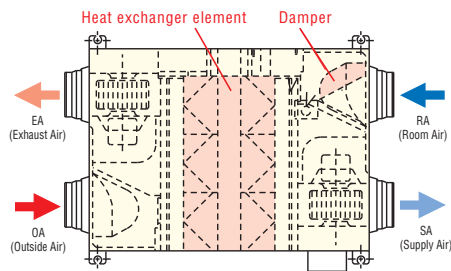

Principle of operation (simple ventilation)

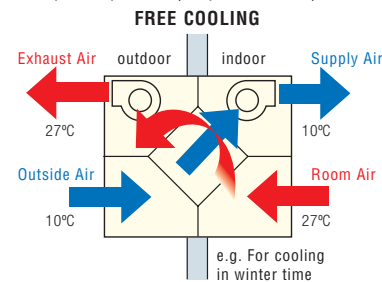

Principle of operation (heat exchanging)

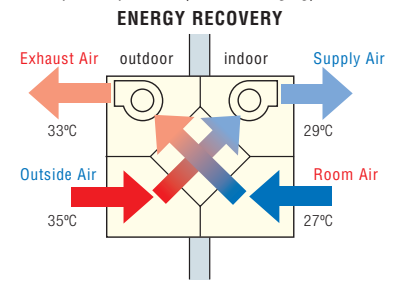

Dimensions

All measurements in mm.

SAF150E7, SAF250E7, SAF350E7, SAF500E7

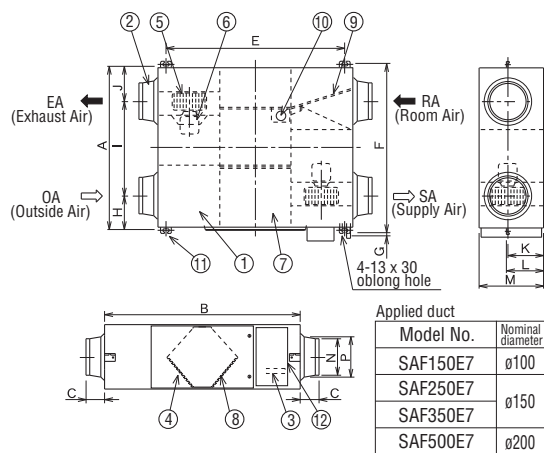

SAF800E7, SAF1000E7

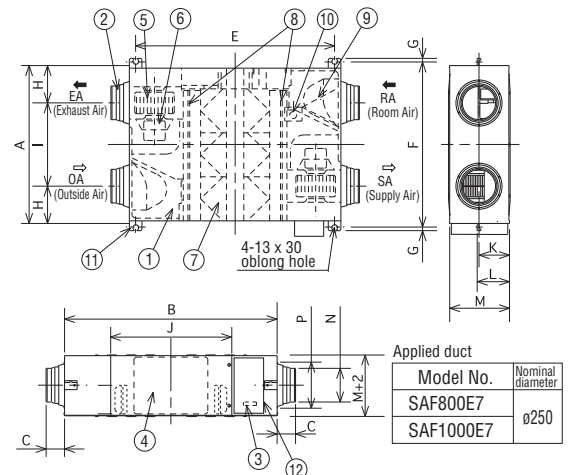

Dimension table

Model	A	B	C	E	F	G	H	I	J	K	L	M	N	P
SAF150E7	467	970	49	810	525	19	82	303	82	135	159	270	ø98	ø110
SAF250E7	599	882	95	655	142		315	142	159	270	ø144	ø164		
SAF350E7	804	1050	70	978	860		112	580	112	159	182	317	ø164	
SAF500E7	904	1090	1018	960	132		640	132	ø194	ø210				

Dimension table

Model	A	B	C	E	F	G	H	I	J	K	L	M	N	P
SAF800E7	884	1322	85	1250	940	19	428	612	194	218	388	ø242	ø258	
SAF1000E7	1134	1190	228	678	612		194	218	388	ø242	ø258			

NO.	Name	Qt'y
①	Frame	1
②	Adaptor	4
③	Terminal board	1
④	Inspection Cover	1
⑤	Fan	2 ※
⑥	Motor	2 ※
⑦	Heat Exchange Element	
	SAF150E7	1
	SAF250E7	1
	SAF350E7	2
	SAF500E7	2
⑧	SAF800E7	3
	SAF1000E7	4
⑧	Filter	2
⑨	Damper	1
⑩	Damper Motor	1
⑪	Suspension fitting	4
⑫	Electrical components box	1

※Model SAF350E7, SAF500E7 have different fan and motor locations.

Installation reference

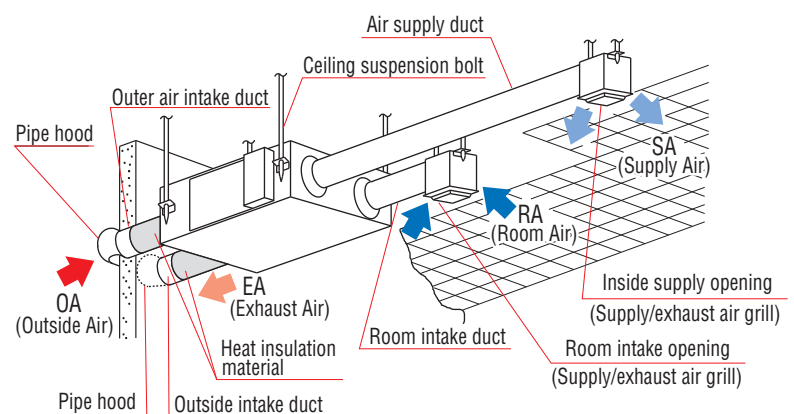

Note: An inspection port is needed for cleaning the heat exchanger and filter 1 or 2 times a year.



Fresh Air DX Assembly

Model No.

- SAF-DX250E6
- SAF-DX350E6
- SAF-DX500E6
- SAF-DX800E6
- SAF-DX1000E6



Drain up kit (option, built-in type)
(600mm)

DXA-DU-E

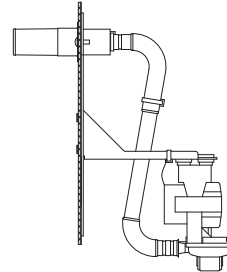

Remote control (option)

Wired



RC-E5

RCH-E3

Wireless



RCN-KIT4-E2

- SAF-DX is a heating or cooling coil incorporating KXZ series controls. It can be used in combination with our SAF series of total heat exchanger.
- Combination of SAF-DX together with other indoor units is possible. The capacity code index of each model is shown below and must be used when making the system selection. Total capacity code index must be within 100% of outdoor unit capacity code index.
- Remote control option is the same as with other indoor units (see above). Connection to all Superlink controls is also possible.
- Optional condensate lift mechanism is also available (600mm height).
- Return air temp. control or supply air temp. control can be selectable.

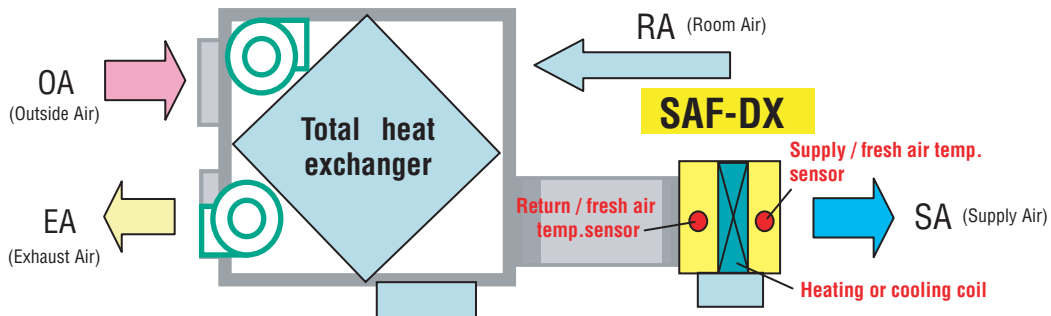

SAF-DX can provide heating or cooling to the fresh air supplied through a 3rd party air handling unit or total heat exchanger such as our SAF series.

Specifications

Item	Model	SAF-DX250E6	SAF-DX350E6	SAF-DX500E6	SAF-DX800E6	SAF-DX1000E6
Nominal cooling capacity *1	kW	2.0	2.8	3.6	5.6	6.3
Nominal heating capacity *2	kW	1.8	2.2	2.8	4.5	5.6
Capacity code		22	28	36	56	71
Power source		1 Phase 220-240V, 50Hz				
Power consumption	Cooling	7.2-7.2				
	Heating	7.2-7.2				
Running current	Cooling	0.05-0.05				
	Heating	0.05-0.05				
Exterior dimensions H x W x D	mm	315 x 452 x 422		315 x 537 x 422	315 x 682 x 422	315 x 822 x 422
Net weight	kg	12.3		13.6	16.1	18.4
Air flow (Standard)	m ³ /h	250	350	500	800	1000
Internal resistance	Pa	38		66		
Remote control(option)		wired: RC-E5, RCH-E3 wireless: RCN-KIT4-E2				
Installation data	mm(in)	Liquid line:ø6.35(1/4") Gas line:ø9.52(3/8")		Liquid line:ø6.35(1/4") Gas line:ø12.7(1/2")		Liquid line:ø9.52(3/8") Gas line:ø15.88(5/8")

(1) The data are measured at the following conditions.

Item	Return/fresh air temperature		Outdoor air temperature		Standards
	DB	WB	DB	WB	
Cooling *1	27°C	19°C	35°C	24°C	ISO-T1
Heating *2	20°C		7°C	6°C	

(2) This air-conditioner is manufactured and tested in conformity with ISO-T1 "UNITARY AIR-CONDITIONERS".

Dimensions

All measurements in mm.

SAF-DX250E6,350E6

Symbol	Content
A	Gas piping $\phi 9.52 (3/8")$ (Flare)
B	Liquid piping $\phi 6.35 (1/4")$ (Flare)
C	Drain piping R1
D	Hole for power source line
F	Wiring hole for total enthalpy heat exchanger
T	Hole for communication line
G	Suspension bolts M10

Space for installatin and service

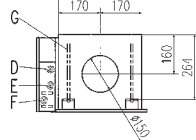
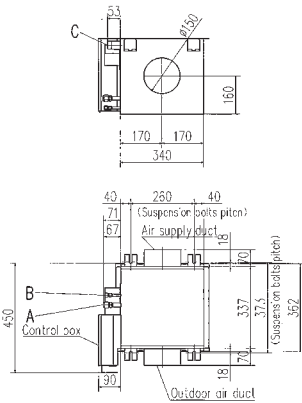
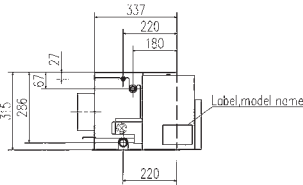
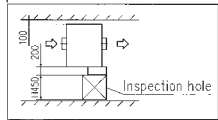

SAF-DX500E6

Symbol	Content
A	Gas piping $\phi 12.7 (1/2")$ (Flare)
B	Liquid piping $\phi 6.35 (1/4")$ (Flare)
C	Drain piping R1
D	Hole for power source line
F	Wiring hole for total enthalpy heat exchanger
T	Hole for communication line
G	Suspension bolts V10

Space for installatin and service

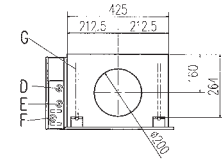
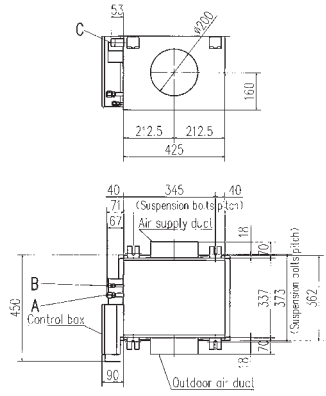
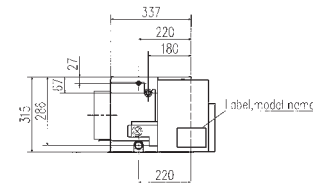
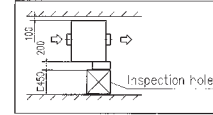

SAF-DX800E6

Symbol	Content
A	Gas piping $\phi 12.7 (1/2")$ (Flare)
B	Liquid piping $\phi 6.35 (1/4")$ (Flare)
C	Drain piping R1
D	Hole for power source line
F	Wiring hole for total enthalpy heat exchanger
T	Hole for communication line
G	Suspension bolts M10

Space for installatin and service

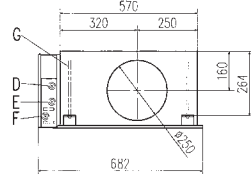
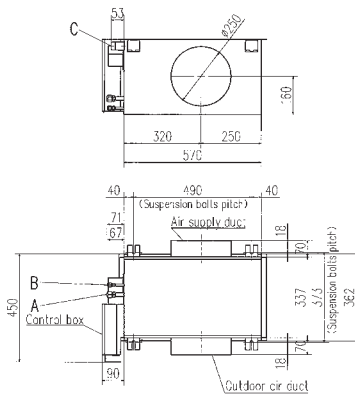
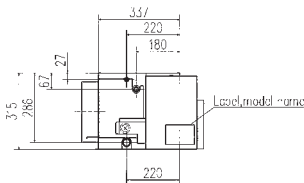
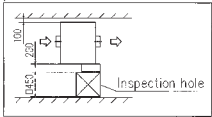

SAF-DX1000E6

Symbol	Content
A	Gas piping $\phi 5.88 (5/8")$ (Flare)
B	Liquid piping $\phi 9.52 (3/8")$ (Flare)
C	Drain piping R1
D	Hole for power source line
F	Wiring hole for total enthalpy heat exchanger
T	Hole for communication line
G	Suspension bolts M10

Space for installatin and service

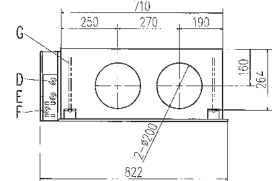
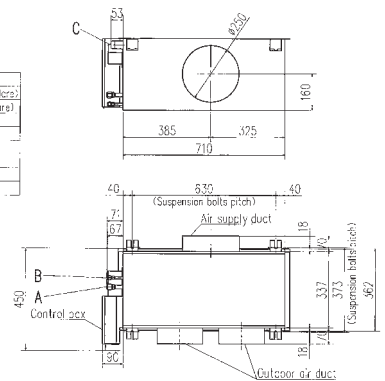
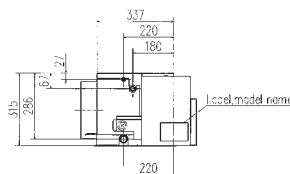
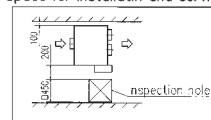

EEV-KIT

- EEV-KIT is the control kit for operating the locally provided AHU or FCU with direct expansion heat exchanger coils in connection with the KXZ/KXE6 system.
(AHU : Air Handling Unit, FCU : Fan Coil Unit)
- EEV-KIT is composed of one EEV-Control ASSY and one EEV-Set.

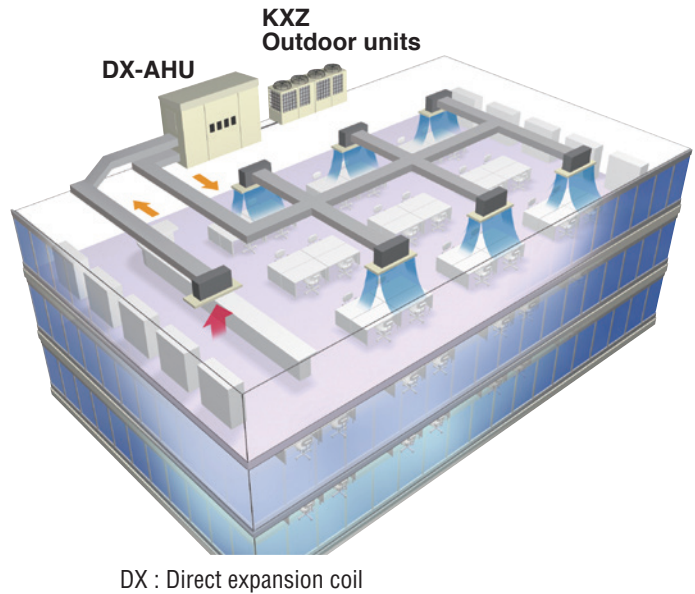
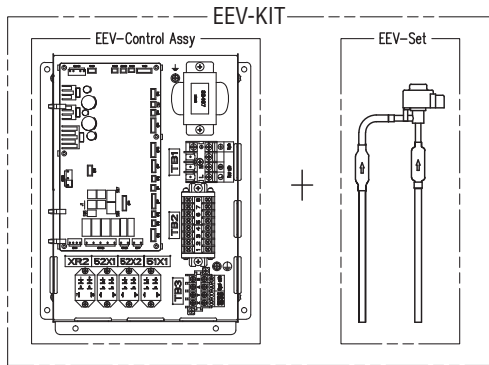

Features

EEV-Control Assy has 2 types.

Refrigeration system	EEV-Control Assy	
	EEVKIT6-E-M	EEVKIT6-E-C
Single	Not Use	1 box-Many boxes
Multiple	1 box (for master)	Many boxes(for slave)

EEV-Set Select from following 3 types according to the coil capacity.

Type	EEV6-71-E	EEV6-160-E	EEV6-280-E
Capacity	22-71	90-160	224-280

System configuration

- Single refrigeration system EEVKIT6-E-C ... Possible with multiple
- Multiple refrigeration system EEVKIT6-E-M (1) + EEVKIT6-E-C ... Possible with multiple (Max32)
- EEVKIT6-E-C is common for both single and multiple refrigeration systems

Single refrigerant system

- Single refrigeration system is one that can have multiple outdoor units on one refrigerant pipe work circuit.
- There are 2 types of EEV-KIT systems that can be built into the single refrigeration system.
- System A : one EEV-KIT.
- System B : multiple EEV-KIT's.

System A

- This system has only one set of EEV-KIT built into one indoor unit with only one heat exchanger. This system can be applied to an indoor unit whose capacity is up to 10HP.

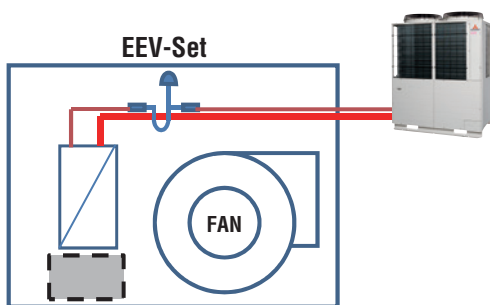

System B

- System B is a system that has multiple EEV-KIT's built into one indoor unit with multiple heat exchangers on one refrigerant circuit.
- This system can be applied up to 60HP (for KXZ) 48HP(for KXE6) AHU capacity.

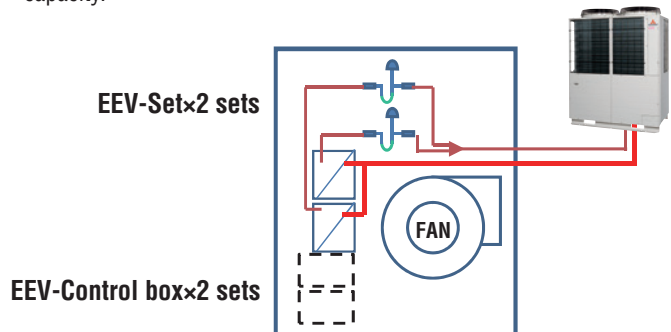

Multiple refrigerant system

- Multiple refrigeration system is an AHU system with
- 1) Multiple independent refrigerant circuits
 - 2) One master control to control the whole system.

Advantages

- Large systems are possible [max capacity 896kW (Indoor unit : 28kW x 32)]
- External control
- Capacity step control

Additional parts over a single refrigeration system

- One master control

The slave EEV control and EEV set are the same as a single refrigeration system.

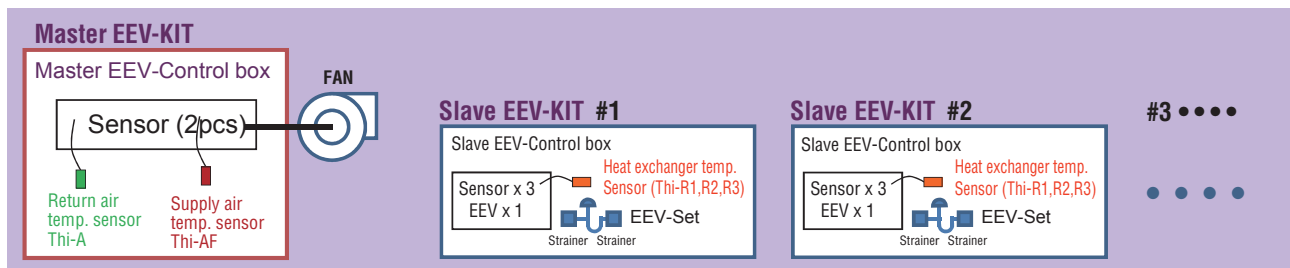
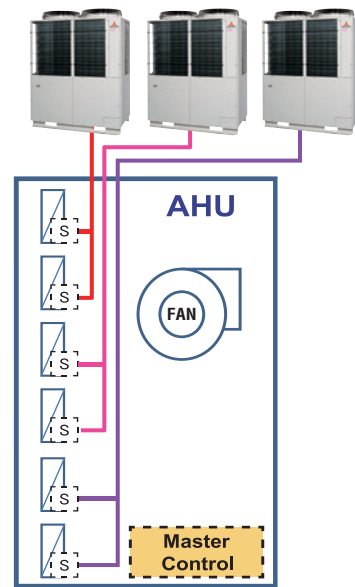

Connection to SUPERLINK II

Single refrigeration system

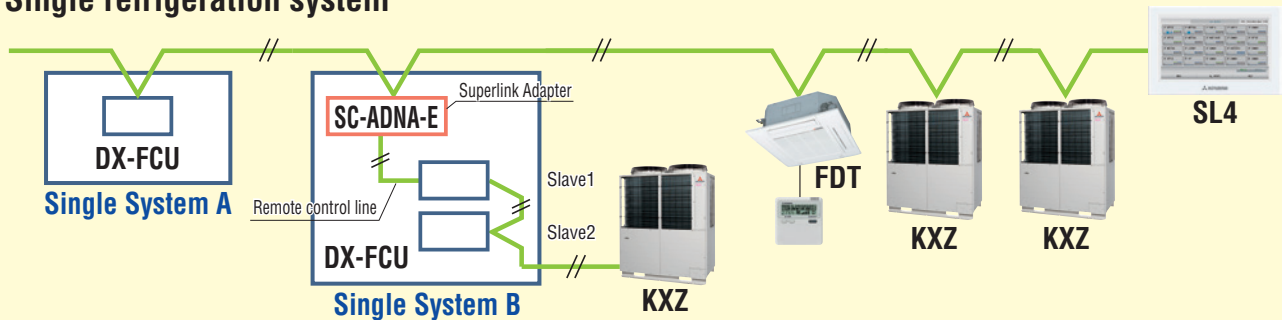

Multiple refrigeration system

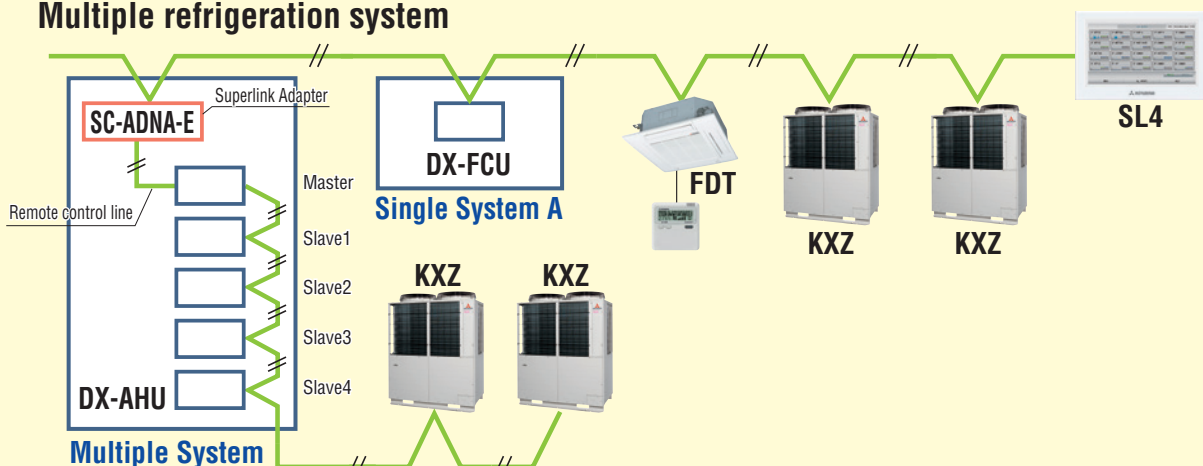



Control Systems

<Individual control>

Remote Control line up

	indoor unit	remote control		indoor unit	remote control		indoor unit	remote control	
wired	all models	RC-EX3A	wireless	FDT	RCN-T-5AW-E2	FDT5	RCN-TS-E2	FDE	RCN-E-E3
		RC-E5		FDTC	RCN-TC-5AW-E2	FDK22~56	RCN-K-E2	FDFW	RCN-FW-E2
		RCN-E3		FDTW	RCN-TW-E2	FDK71	RCN-K71-E2	others*	RCN-KIT4-E2

*FDTQ, FDU, FDUU, FDUT, FDUH, FDU-F

Wired remote control (option)

RC-EX3A

Intuitive touch controller with Liquid Crystal Display

User friendly

- LCD panel with light tap operation introduced as the industry's first
- Simple interface with only three buttons

Easy view

- Big LCD with 3.8 inch full dot display
- Back light function
- Multi language display (12 languages)

Operation mode setting screen

The desired operation mode can be selected by simply tapping this button.

Setting temperature screen

You can select the temperature as desired by tapping ▲▼ button.

Operation mode

- Cooling
- Fan
- Dry
- Heating
- Auto

Run / Stop

High power operation

The highest capacity operation (Max 15 minutes)

- Increasing compressor speed
- Increasing air flow volume

Energy-saving operation

- Changes set temperature.
At 28°C in cooling mode and 22°C in heating mode, 25°C in auto mode.
- Operation correction by outdoor temperature

2. Main functions

	Function name	Description
Economy & Timer	Energy-saving operation	Since the capacity is controlled automatically based on the outdoor temperature, energy can be saved without losing comfort.
	Sleep timer	Set the time period from start to stop of operation. The selectable range of setting time is from 30 to 240 minutes (at 10-minute intervals).
	Set temperature auto return	The temperature automatically returns to the previously set temperature.
	Set ON timer by hour	When the set time elapses, the air conditioner starts.
	Set OFF timer by hour	When the set time elapses, the air conditioner stops.
	Set ON timer by clock	The air conditioner starts at the set time.
	Set OFF timer by clock	The air conditioner stops at the set time.
	Weekly timer	On or Off timer can be set on a weekly basis.
	Peak-cut timer	Capacity control can be set by using peak cut function on RC-EX3A for better energy saving. Five-step capacity control is available.
	Home leave operation	When the unit is not used for a long period of time, the room temperature is maintained at a moderate level, avoiding extremely hot or cool temperatures.
Comfort	Big LCD & Touch screen panel	Large 3.8 inch screen has resulted in improved visibility and operability.
	Easy modification of Individual flap control	User can visually confirm and set the direction of flaps using the visual display on the remote controller.
	Automatic fan speed *1	The micro-computer automatically adjusts the airflow effectively to follow the changes of return air temperature.
	Temp increment setting	Temperature increment for the change of the set temp can be changed.
Convenience	Silent mode	Set the period of time to operate the Outdoor unit with prioritizing the quietness.
	Function switch	The function switch allows user to select and set two functions among available functions.
	Favorite setting	Operation mode, set temperature, fan speed and air flow direction automatically adjust to the programmed favorite setting.
	Adjusting Brightness of the background light	The brightness of the background light can be adjusted by 10 stages.
	LCD contrast setting	This function allows user to adjust LCD display contrast.
	High power operation	High Power Mode increases the unit operating ability for 15 minutes to quickly adjust the room temperature to a comfortable level.
	Back light setting	This convenient function allows user to see controls under low light conditions.
	Administrator settings	This function only allows specific individuals to operate the unit.
	Setting temp range	Limited range of setting temperature in the heating or the cooling operation can be selected.
	External Input/Output Function	The external input/output of indoor unit by remote controller can set input/output based on user needs.
Service	Select the language	Set the language to be displayed on the remote control.
	USB connection (mini-B)	This function allows batch input of schedule timer settings and other settings involving a large amount of data.
	Error code display	This function allows user to check information displayed when abnormal function of the unit occurs.
	Operation data display	Displays various types of air conditioner operation data in real time.
	Contact company display	Address of the service contact is displayed.
	Filter sign	Announces the due time for cleaning of the air filter.
	Static pressure adjustment	Allows user to adjust duct static pressure using the remote control.
Backup Control	Allows for rotation control, fault backup control, and capacity backup control.	

*1 Cannot be used when a centralized control remote is connected.

Wireless remote control (option)

For wireless control simply insert the infra-red receiver kit on a corner of the panel

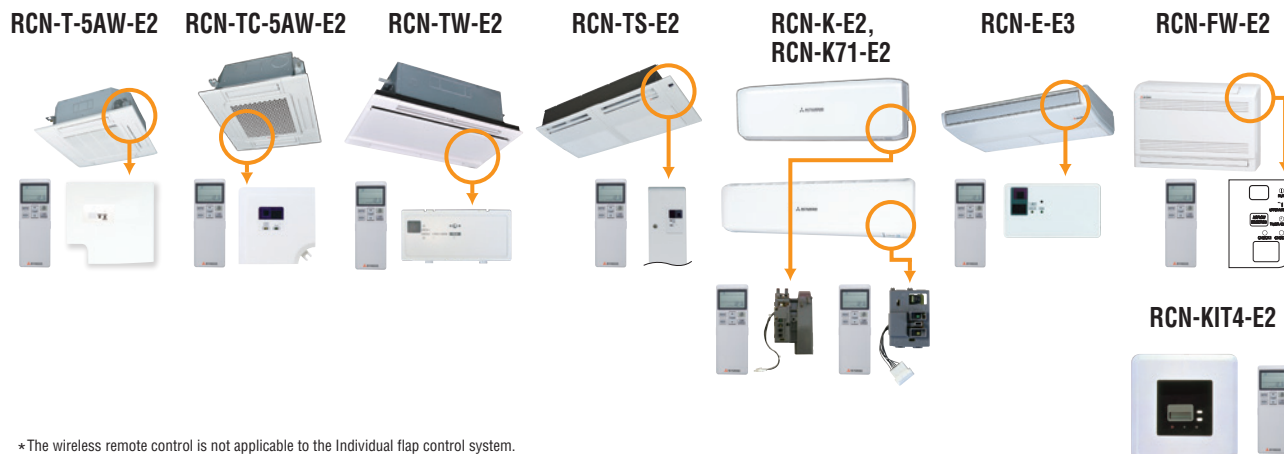

*The wireless remote control is not applicable to the Individual flap control system.

Wired remote control (option)

RC-E5



The RC-E5 controller enables extensive access to service and maintenance technical data combined with easy to use functions and a clear LCD display.

Weekly timer function as standard

RC-E5 provides (as a standard feature) a weekly timer, which allows one-week operation schedules to be registered. A user can specify up to four times a day to start/stop the air conditioner. (Temperature setting is also possible with the timer).

Timer operation

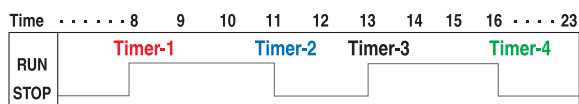

Run hour meters to facilitate maintenance checking

RC-E5 stores operation data when an anomaly occurs and indicates the error on the LCD. It also displays cumulative operation hours of the air conditioner and compressor since commissioning.

Room temperature controlled by the remote control sensor

The temperature sensor is housed in the top section of the remote control unit. This arrangement has improved the sensitivity of the remote control unit's sensor, which permits more finely controlled air conditioning.



Changeable set temperature ranges

RC-E5 allows the upper and lower limits of a set temperature range to be specified separately. By adjusting a set temperature range, you can ensure energy saving air conditioning by avoiding excessive cooling or heating.

Changeable range	
Upper limit	20~30°C(effective for heating operation)
Lower limit	18~26°C(effective for non-heating operation)

Simple remote control (option)

RCH-E3 (wired)



Designed specially for hotel rooms, the controller's buttons are limited only to the minimum required functions such as ON/OFF, mode, temperature setting and fan speed. It is really simple and easy to use.

Up to 16 units

It can control up to 16 units individually, with pressing the AIR CON No. button.

AUTO restart

This function allows starting the air conditioner automatically when power supply is restored after power failure or by turning on the power switch.

*RCH-E3 is not applicable to the Individual flap control system.
*When RCH-E3 is used, the fan speed setting can only be set to 3 speed settings (Hi-Me-Lo).

Thermistor (option)

SC-THB-E3

In case the sensor integrated in the indoor unit or in the remote controller is unable to sense the room temperature correctly, or an individual controller in each room is not required but a temperature sensor is (as when a central control system is in place), install SC-THB-E3 in an adequate location in the room.



8m



<SUPERLINK® - II Control System>

Mitsubishi Heavy Industries Thermal Systems has now combined simplicity of installation with our highly sophisticated Superlink-II control system, to offer building owners and occupiers a comprehensive control and management system, while providing complete commissioning and service maintenance assistance for installers and service engineers. The Superlink-II network utilises two wire, non-polar cable - for further details of wiring. Superlink-II is an advanced high speed data transmission system that can connect up to 128 indoor units and 32 outdoor units as a network. Mitsubishi Heavy Industries Thermal Systems offers a wide range of control options for the Superlink-II network to suit any application large or small, as well as connection to new or existing building management systems. Individual Mitsubishi Heavy Industries Thermal Systems split systems can also be integrated on to the Superlink-II network using SC-ADNA-E.

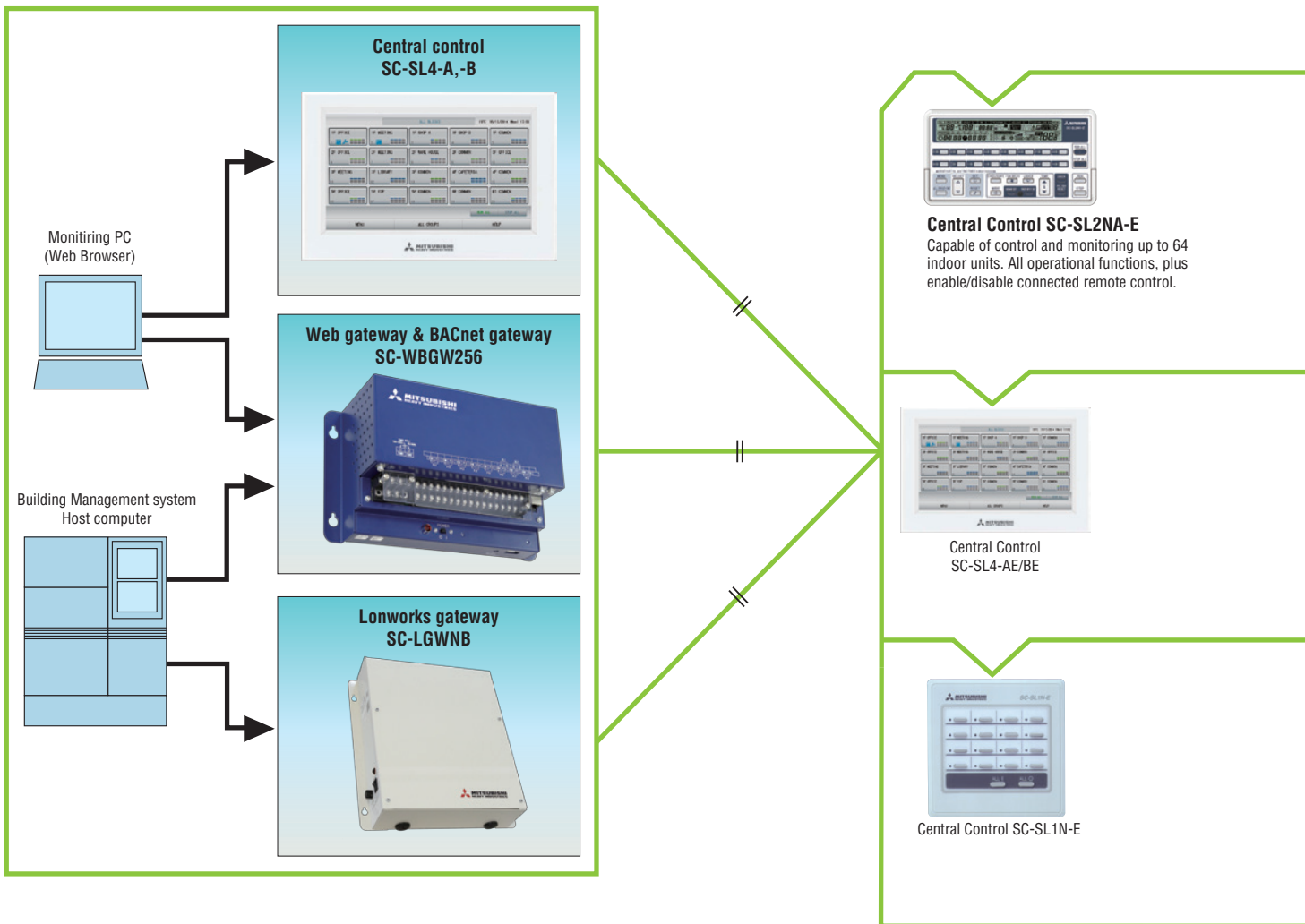

SUPERLINK E BOARD(SC-ADNA-E)

This board is used when conducting control of the single package (wired remote control unit) 1-type series using a network option.

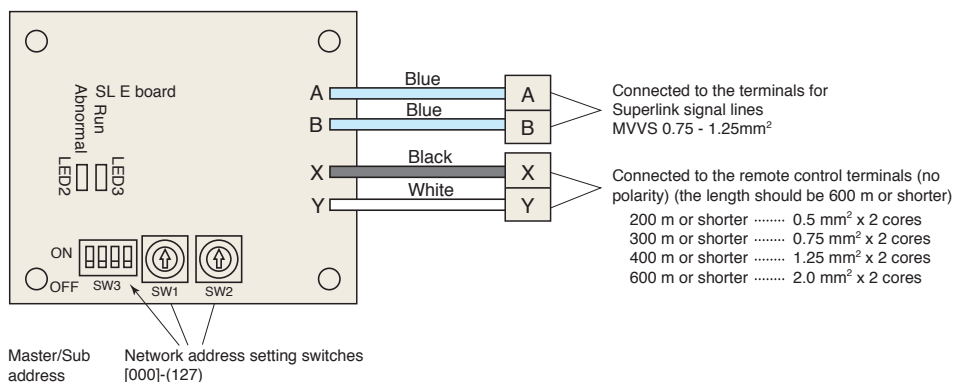

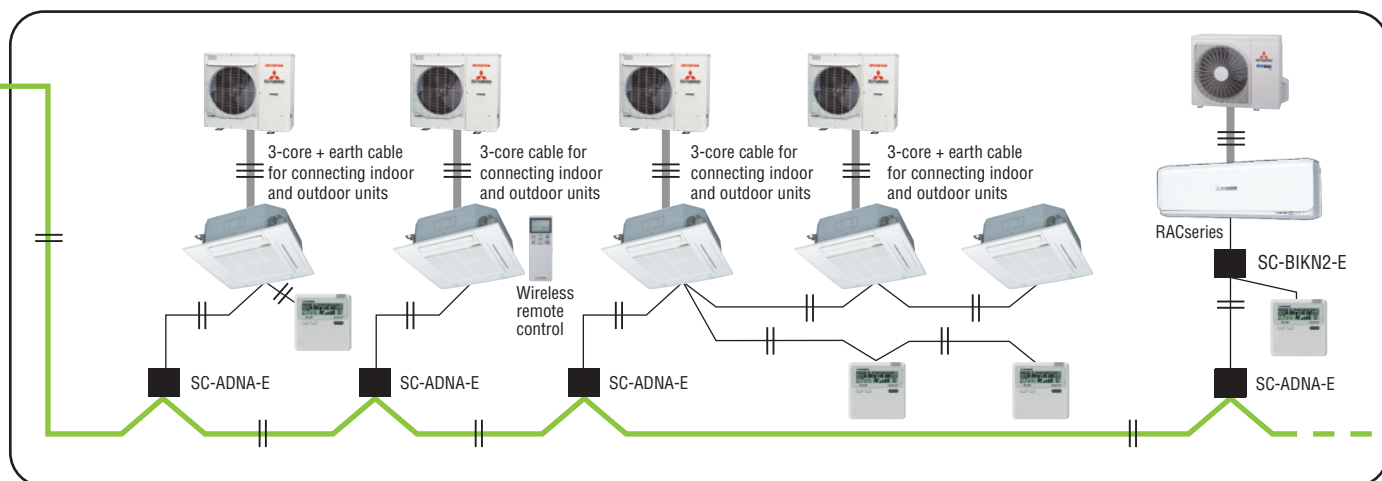
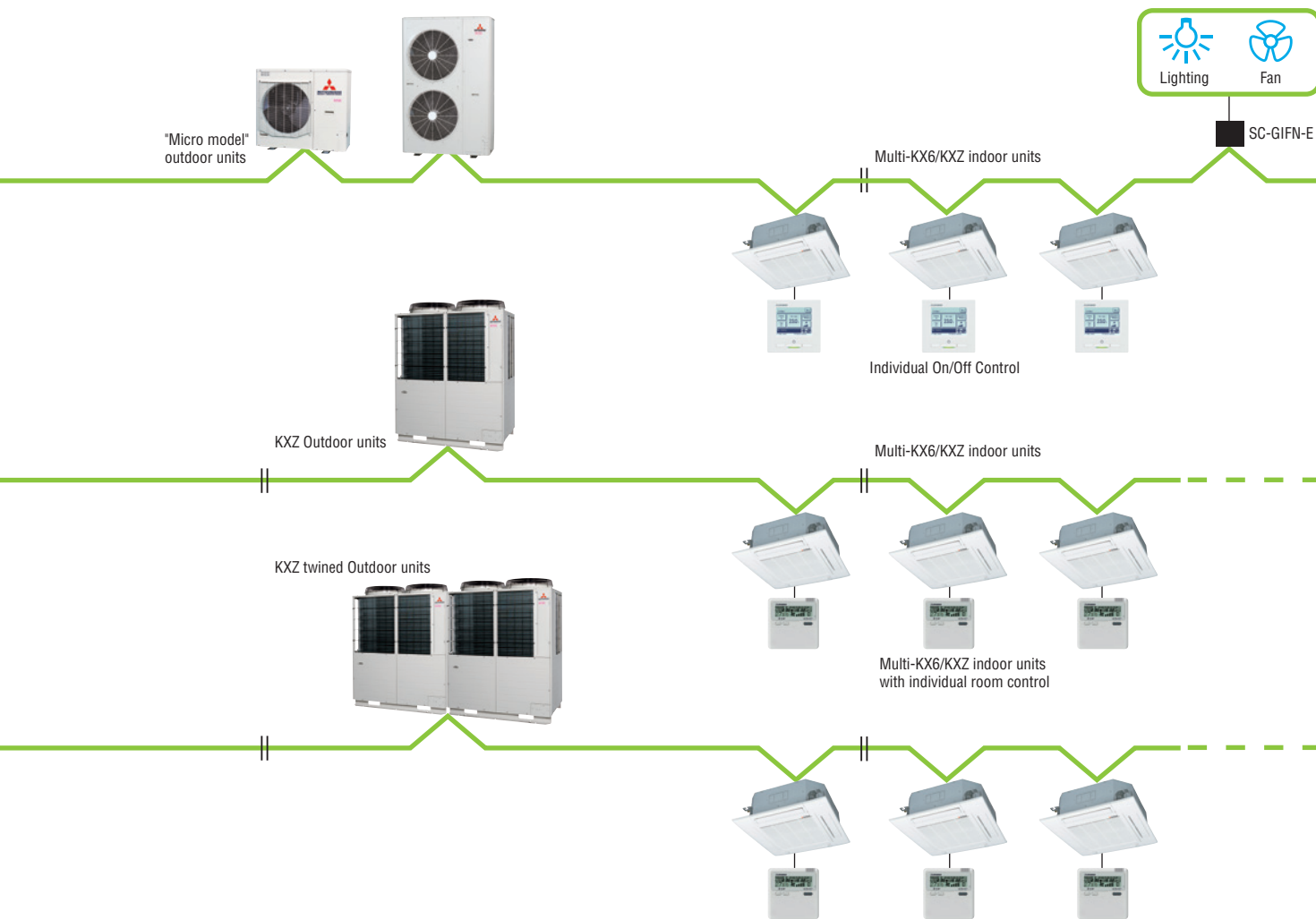



<Central Control> SC-SL4-AE/BE

Mitsubishi Heavy Industries Thermal Systems introduces the full colour touch screen central control SC-SL4-AE/BE, with 9 inch interactive LCD display. Offers control, monitoring, scheduling and service/maintenance functions for up to 128 indoor units.

Control with PC is available by use of internet explorer.

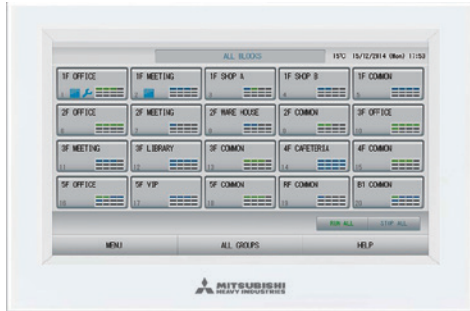

Control	Monitoring	Scheduling	Administration/Service
Run/Stop / Home leave	Operating state	Yearly schedule	Block definition, Floor layout
Mode (cool/heat/fan/dry/Auto)	Mode	Today's schedule	Group definition
Set temperature	Set temperature	Detailed daily schedule	Unit definition
Operation permitted/prohibited	Room temperature	Season setting	Time and date setting
Fan speeds	Operation permitted/prohibited		Alarm history
Air direction	Fan speed		Energy consumption calculation period
Filter sign reset	Air direction		Energy consumption, cumulative operation time
Demand control (3 steps)	Filter sign		Flap control setting
Emergency stop	Maintenance (1, 2 or back-up) Outdoor air temperature		Operation data monitoring Data logging (Run / Stop set temperature , room temperature , outdoor air temperature)

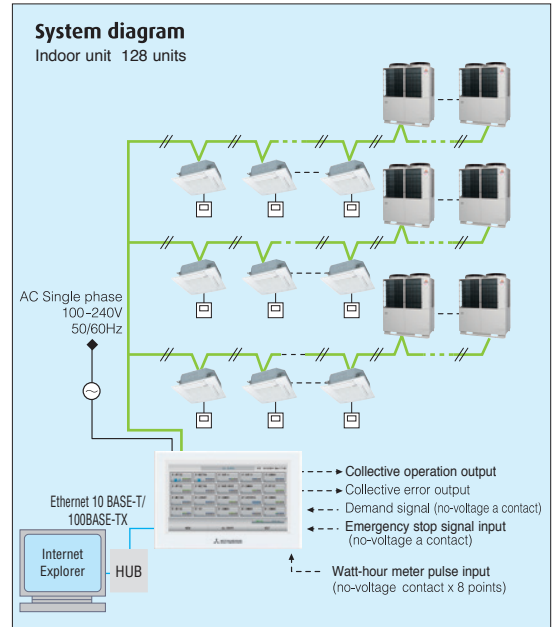

PC requirements: Windows Vista or Windows 7, 8.1, 10
Monitor resolution 1280 x 1024 or more.
Web browser requirements: Internet Explorer 11

Schedule setting

For each group

Schedule settings for each group are possible. The RUN/STOP/HOME LEAVE time, operation mode, remote control Lock/Unlock setting, temperature setting, energy setting, and silent mode can be set up to 16 times per day.



Yearly Schedule

Schedule settings for a year are also possible. The weekday, holiday, special day 1 or special day 2 can be selected and set.



Operation time history

Possible to check operation time history for cooling and heating separately.

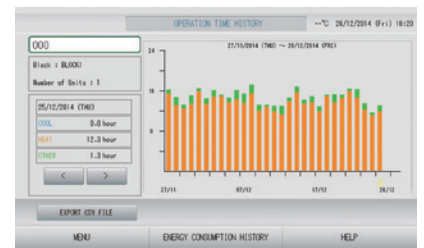

Alarm history

A maximum of 300 records is displayed for the history of error occurrence and restoration in the unit of air-conditioner. It is possible to output the history data to a CSV data file.

High visibility

Increasing in size from 7 to 9 inches

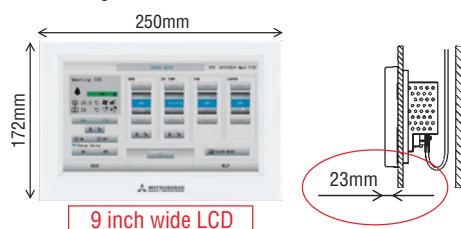

Contrast between five colours for icon display and black light base screen has achieved high visibility.

- Green : in operation
- Blue : stop
- Red : error
- Yellow : communication error
- Gray : no groups

Block layout function

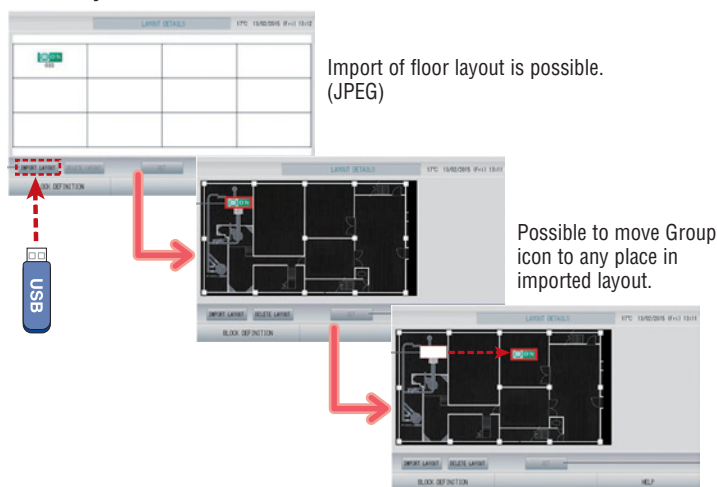

Web function

You can monitor and control up to 128 indoor units (Max.128 groups) from a PC or tablet PC.

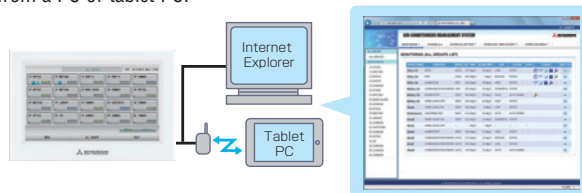

<Example>
Monitoring and operating air-conditioners in a lecture room of a university

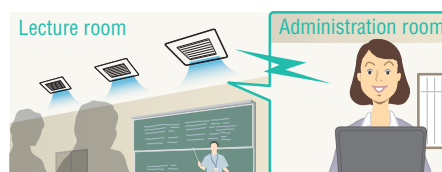

3 levels of demand control from 2 external inputs

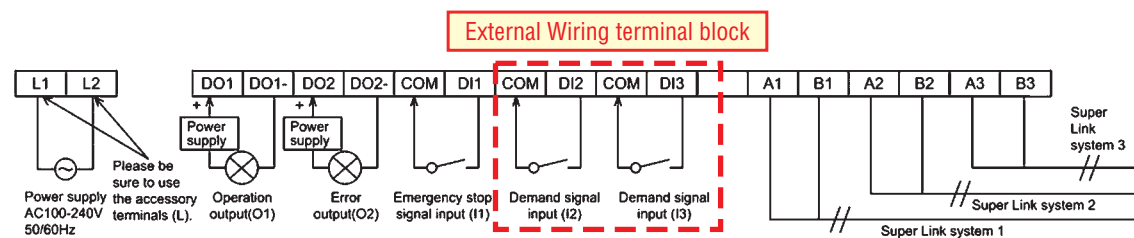

Demand level	Control	Not objective			Set to D1			Set to D2			Set to D3		
		Set temp.	Operation mode	Center/Remote	Set temp.	Operation mode	Center/Remote	Set temp.	Operation mode	Center/Remote	Set temp.	Operation mode	Center/Remote
0	Normal	-	-	-	-	-	-	-	-	-	-	-	-
1	Temp. shift	-	-	-	Shift	-	Center	-	-	-	-	-	-
2	Fan (1stage)	-	-	-	-	Fan	Center	-	Fan	Center	-	-	-
3	Fan (2stage)	-	-	-	-	Fan	Center	-	Fan	Center	-	Fan	Center

Demand level 1 – Any indoor unit set to D1 (Demand level 1) has its temperature set point shifted by +2°C in cooling mode or -2°C in heating mode and cannot be operated from the local remote controller

Demand level 2 – Any indoor unit set to D1 or D2 switch to fan only mode and cannot be operated from the local remote controller

Demand level 3 – Any indoor unit set to D1 or D2 or D3 switch to fan only mode and cannot be operated from the local remote controller

Electric power calculation function:

(for SC-SL4-BE only)

SC-SL4-BE gives electric power consumption data (kWh) for each indoor unit, each group, each SUPERLINK-II system, and each watt-hour meter input.



	SC-SL4-BE
Export data by	USB / LAN
Calculation software	Included
Watt-hour meter pulse input (Maximum)	8
Max connectable indoor units	128

Item	Model	SC-SL4-AE/SC-SL4-BE
Ambient temperature during use		0 ~ 40°C
Power supply		1 Phase 100-240V 50/60Hz
Power consumption		9W
External dimensions (Height x Width x Depth)		172mm x 250mm x 23 (+70) mm
Net weight		2.0kg
Number of connectable units (indoor units)		up to 128 units
LCD touch panel		Colour LCD, 9 inches wide
Inputs	SL (Superlink) signal inputs	1 system (Super link-II)
	Watt-hour meter pulse input*	8-point, pulse width 80ms or more
	Emergency stop signal input*	1 point, non-voltage a contact input continuous input (closed, forced stop)
	Demand signal input*	2 point, non-voltage a contact input continuous input (closed, demand control)
Outputs	Operation output	1 point, maximum rated current 40mA, DC24 V All units stop; Open, any unit operating; Close
	Error output	1 point maximum rated current 40mA, DC24 V Normal; closed. If even one unit is abnormal; Open (Open/closed can be changed)

* The receiving side power supply is DC 12V (10mA).
The air conditioning charges calculations of this unit are not based on OIML, the international standard.



SC-SL1N-E

Start/stop control of up to 16 indoor units either individually or collectively.
Simple centralised control.

1. The SC-SL1N-E is connected to the Superlink-II network via 2-core, non-polar wires ('AB' connection).
2. It will monitor and control the start/stop function of up to 16 units, with the sixteen operation button.
3. The unit or group numbers in operation or in need of service are displayed with an LED.
4. Collective start/stop is also available through the simultaneous on/off button.
5. Up to 12 SC-SL1N-E units can be connected to a Superlink-II network (consisting of up to 128 indoor units).
6. If a power failure occurs, the SC-SL1N-E will resume the operation of the system according to a stored operation condition, once power is restored.



SC-SL2NA-E

Central control of up to 64 indoor units including weekly timer function as standard.

1. The SC-SL2NA-E is connected to the Superlink-II network via 2-core, non-polar wires ('AB' connection).
2. It will monitor and control the start/stop function of up to 16 units, or 16 groups of units, with the sixteen operation buttons.
3. It also monitors and controls the following functions for individual units, groups of units or the complete network: operation mode, set point temperature, return air temperature, louvre position, error code. Air flow and center lock function.
4. The unit or group numbers in operation or in need of service are displayed with an LCD.
5. Collective start/stop is also available through the simultaneous on/off button.
6. If a power failure occurs, the SC-SL2NA-E will resume the operation of the system according to a stored operation condition, once power is restored.
7. The SC-SL2NA-E can be connected to an external timer to facilitate timed on/off cycles.

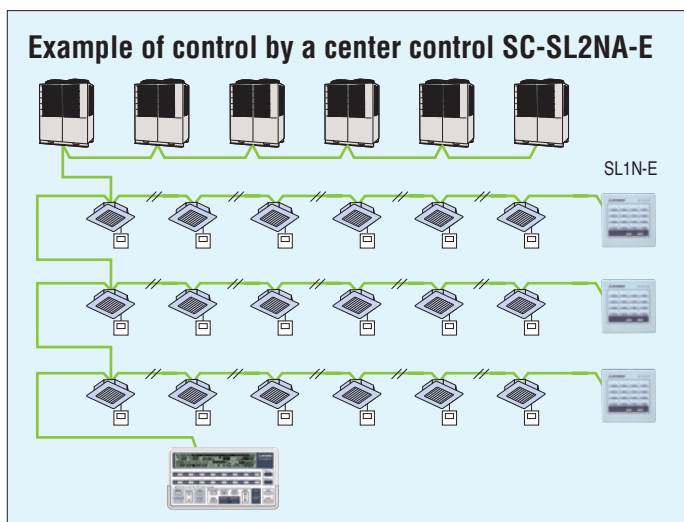
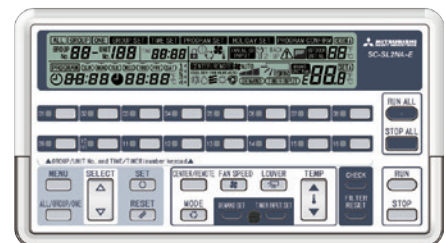

An SC-SL2NA-E performs the start/stop control, monitoring and mode setting of up to 64 units. It is a high quality air conditioner control system that allows up to 64 indoor units to be freely grouped into 1 to 16 groups.

It allows not only the start/stop control but also the monitoring, display of operation statuses such as in operation or in need of service and mode setting such as switching of operation modes of connected units collectively, by group or individually.

- Outer dimensions: H120 x W215 x D25+35* mm.
- 35* is the measurement including the part contained in a recess.

Note: Please consult dealer for combination of center controls and Building Management Systems interface units.

SC-GIFN-E Interface kit

- Applicable products
Ventilation fan, Air purifier
- By using SC-GIFN-E together with central control such as SC-SL1N-E, SC-SL2NA-E and SC-SL4-AE/BE, you can start-stop, operate & monitor the operation of applicable products.

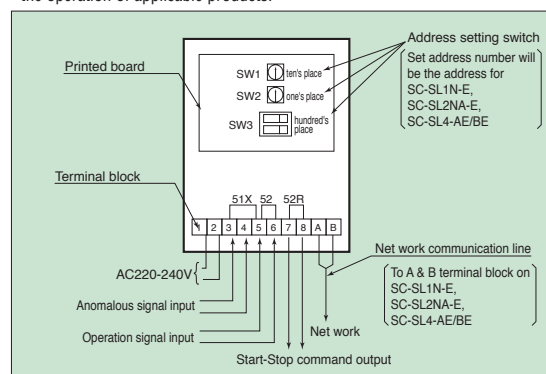

<Building Management Systems> SC-WBGW256 (Web gateway+BACnet gateway)

Production by order

SC-WBGW256 controls and monitors of up to 256 cells (some cells can have two or more indoor units and total number of indoor units can be up to 256 units) centralised to a network PC using the Superlink-II web gateway. Simple installation is assured with no special software requirements, operation is via Internet Explorer. A low power embedded CPU and compact flash ROM ensure a large storage capacity with high reliability (no moving parts such as a PC fan, etc). An IP address filter function combined with three-level user authentication check also ensures security.

Also, SC-WBGW256 can be used as interface devices that convert Mitsubishi Heavy Industries Superlink-II communication data to BACnet code and are controlled centrally from a building management system.



Additional engineering service cost etc. is required.
Please consult your dealer when using this central control.

[In case of web gateway]

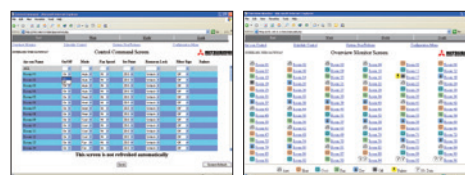
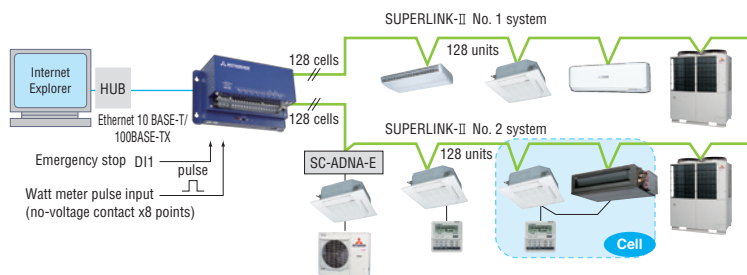

PC requirements: Windows 7 or Windows 8.1.
Monitor resolution 1364 x 768.

[In case of BACnet gateway]

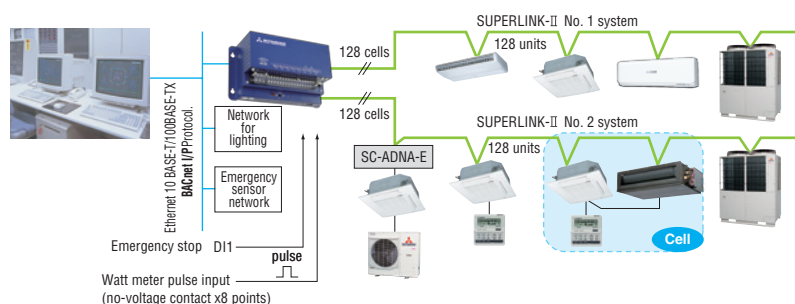

Users can manage up to 1024 units by connecting the four devices!!

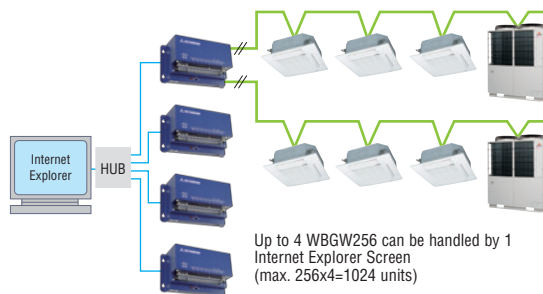

Up to 4 WBGW256 can be handled by 1 Internet Explorer Screen (max. 256x4=1024 units)

SC-LGWNB (LonWorks gateway)

Production by order

SC-LGWNB is an interface device that converts Mitsubishi Heavy Industries Superlink-II communication data to LonWorks code. Control and monitoring functions of the a/c system for up to 96 indoor units can be integrated to a central control point via the building management system network.

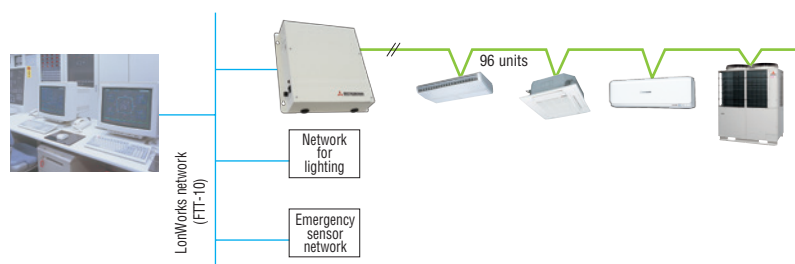

Additional engineering service cost etc. is required.
Please consult your dealer when using this gateway.

Before starting use

Heating performance

The heating performance values (kW) described in the catalogue are the values obtained by operating at an outdoor temperature of 7°C and indoor temperature of 20°C as set forth in the ISO Standards. As the heating performance decreases the outdoor temperature drops, if the outdoor temperature is too low and the heating performance is insufficient, use other heating appliances as well.

Indication of sound values

The sound values are the values (A scale) measured in a chamber such as an anechoic chamber following the ISO Standards. In the actual installation state, the value is normally larger than the values given in the catalogue due to the effect of surrounding noise and echo. Take this into consideration when installing.

Use in oil atmosphere

Avoid installing this unit in an atmosphere where oil scatters or builds up, such as in a kitchen or machine factory. If the oil adheres to the heat exchanger, the heat exchanging performance will drop, mist may be generated, and the synthetic resin parts may deform and break.

Use in acidic or alkaline atmosphere

If this unit is used in acidic atmosphere such as hot spring areas having high level of sulfuric gases or in alkaline atmosphere including ammonia or calcium chloride, places where the exhaust of the heat exchanger is sucked in, or at coastal areas where the unit is subject to salt breezes, the outer plate or heat exchanger, etc., will corrode. Please ask a dealer or specialist when you use an air conditioner in places differing from a general atmosphere.

Use in places with high ceilings

If the ceiling is high, install a circulator to improve the heat and air flow distribution when heating.

Refrigerant leakage

The refrigerant (R410A) used for Air conditioner is non-toxic and in its original state.

However, in consideration of a state where the refrigerant leaks into the room, measures against refrigerant leaks must be taken in small rooms where the tolerable level could be exceeded. Take measures by installing ventilation devices, etc.

Use in snowy areas

Take the following measures when installing the outdoor unit in snowy areas.

•Snow prevention

Install a snow-prevention hood so that the snow does not obstruct the air intake port or enter and freeze in the outdoor unit.

•Snow piling

In areas with heavy snow fall, the piled snow could block the air intake port. In this case, a frame that is 50cm or higher than the estimated snow fall must be installed underneath the outdoor unit.

Automatic defrosting device

If the temperature is low, and the humidity is high, frost will stick to the heat exchanger of the outdoor unit. If use is continued, the heating performance will drop.

The "Automatic defrosting device" will function to remove this frost. After heating for approx. three to ten minutes, it will stop, and the frost will be removed. After defrosting, hot air will be blown again.

Servicing the air-conditioner

After the air-conditioner is used for several seasons, dirt will build up in the air-conditioner causing the performance to drop. In addition to regular servicing, a maintenance contract by a specialist is recommended.

Safety Precautions

Air-conditioner usage target

The air-conditioner described in this catalogue is a dedicated cooling/heating device for human use.

Do not use it for special applications such as the storage of food items, animals or plants, precision devices or valuable art, etc.

This could cause the quality of the items to drop, etc.

Do not use this for cooling vehicles or ships. Water leakage or current leaks could occur.

Before use

Always read the "User's Manual" thoroughly before starting use.

Installation

Always commission the installation to a dealer or specialist. Improper installation will lead to water leakage, electric shocks and fires.

Make sure that the outdoor unit is stable in installation. Fix the unit to stable base.

Usage place

Do not install in places where combustible gas could leak or where there are sparks.

Installation in a place where combustible gas could be generated, flow or accumulate, or places containing carbon fibers could lead to fires.

Mitsubishi Heavy Industries Thermal Systems, Ltd.

(Wholly-owned subsidiary of MITSUBISHI HEAVY INDUSTRIES, LTD.)

2-3 Marunouchi 3-chome, Chiyoda-ku, Tokyo 100-8332, Japan

<https://www.mhi-mth.co.jp/en/>

Our factories are ISO9001 and ISO14001 certified.

Certified ISO 9001



Certificate Number : JQA-0709



Certificate:44 100 980813



Certificate Number : 4333-2007-AQ-RQC-RVA

Certified ISO 14001



ISO 14001
Certificate Number : YKA4005636



Certificate:04 104 980813



Certificate number : 02117E10160POM

