

# air

Localize Contents

Company Name

CUSTOMER SERVICE

SALES OFFICE

SPARE PARTS

DISTRIBUTOR

#### CERTIFICATION



Concerning [Quality Management Systems]  
ISO 9000 series  
Hitachi-Johnson Controls Air Conditioning, Inc.  
Shimizu Factory  
JQA-1084 obtained in November 1995



Concerning [Environmental Management Systems]  
ISO 14000 series  
Hitachi-Johnson Controls Air Conditioning, Inc.  
Shimizu Factory  
EC97J1107 obtained in October 1997



Concerning [Occupational Health and Safety Management Systems]  
ISO45001/ OHSAS 18001  
Hitachi-Johnson Controls Air Conditioning, Inc.  
Shimizu Factory  
WC18J0002 obtained in July 2018

\*Not all the products listed in this catalogue are not manufactured in Shimizu Factory.  
Please consult the distributor for more details.

#### WARRANTY

#### SOCIAL MEDIA

HITACHI

# air365 Max

VARIABLE REFRIGERANT FLOW SYSTEM  
COOLING ONLY TYPE



Cooling & Heating



# Index

03

## Message

09

## Outdoor units

11 | End-to-end solution

35 | Air source Cooling Only type (Line up)

49

## Indoor units

63 | Ducted units

69 | Ceiling cassettes

77 | Other indoor units

95

## Ventilation

99 | Ventilation solutions

101 | Dx-kit

103

## Controllers

105 | Centralized controllers

111 | Individual controllers

121 | Accessories

123 | H-link



## Air. It's a wonderful thing.

Invisible, silent and life-giving, air makes our entire world possible. It surrounds us, continuously energizing, cooling and warming. It can be unpredictable and sometimes challenging, but when air is in harmony with us, everything seems that much easier.

This is our vision.  
To create the air that makes life better.



## The beauty of balance

No matter what the weather is like outside, when you're indoors, you want to have complete control over your environment. At work or play, awake or asleep, you're free to create your own atmosphere; balancing energy with calm, sound with silence and light with shade. It's the same for cooling and heating.

When the air around you is in balance, you can enjoy life indoors that much more.

## Air is harmony

At Hitachi Cooling & Heating we like to think of this as creating harmony with your interior environment. When we achieve that wonderful balance, productivity, learning, happiness and health can thrive.

We call this 'air is harmony' and it's at the center of everything we do.



## The future together

Living Harmony puts people first. By balancing the human needs of our customers with an uncompromising approach to innovation and quality, we can continue to create the technologies for a more comfortable and balanced world.

Your world. We live in it together.



# Adapted to your spaces



## FLEBILITY

- A COMPLETE solution for whole office spaces; Large ESP Ducted IDU or AHU integrated to VRF for large entrance & conference room, Twin-Sense panel 4-way cassette for meeting rooms, Ventilation units and VRF indoor units for any working space
- Any shape of buildings including high-rise one can be suitable for VRF unit, with max 110m height difference & total 1,000m piping length availability

## SUSTAINABLE GROWTH

- Highest EER max up to 5.40 & specially optimized operation for part-load operation thanks to SmoothDrive 2.0 technology
- Achieve green-building certificate by more greenery appearance of buildings thanks to less-ODU occupied space & less-refrigerant necessary unit
- Smart monitoring and control: to cut the wasteful energy consumption by each checking status of units from airCloud Pro anywhere anytime

## WELL-BEING

- Right Temperature: Always constant and best cooling by several comfort features
- Right Feeling; airflow control with sensor & original technology + less noise operation!
- Right Purity: many IAQ supporting units



## FLEBILITY

- Compact yet powerful cabinet of modular combination capability is SPACE-SAVING solutions, enabling placement on anywhere and transportation can be easier
- Higher flexibility of piping length can help ODUs installed all in one place so that whole installation cost can be decreased & for maintenance ease & less indoor noise bothering

## SUSTAINABLE GROWTH

- Less is More!: thanks to max 200% IDU combination capacity, purchase fewer ODUs is okay!
- Efficiency designed-in; Highest EER max up to 5.40 with other intelligent operations (Auto-Save or Setback function) + SmoothDrive 2.0 technology optimizing part-load smooth operation leading to better and lower running cost!
- Thanks to airCloud Tap (installation & service support app), you can minimize the time and cost for VRF configuration and regular maintenance

## WELL-BEING

- Right Temperature: Always constant and best cooling
- Right Feeling; airflow control with sensor & original technology + less noise operation!
- Right Purity: many IAQ supporting units



## FLEBILITY

- Quicker installation can be achieved by 1. large-capacity yet smaller-footprint and lighter weigh outdoor units 2. both H-LINK & airCloud Tap features can help installers work quickly and efficiently within the limited time (like off-school time on weekends)
- Several types of IDUs to meet any type of application or room shapes for easier installation and better cost-performance balance.

## SUSTAINABLE GROWTH

- Help decrease the running cost thank to 1. Highest EER max up to 5.40 & 2. specially optimized operation for part-load operation by SmoothDrive 2.0 technology
- "Individual controller LOCK mode" for safer operation which prevents inappropriate operation by young students.
- Smart monitoring and control: to cut the wasteful energy consumption by each checking status of units from airCloud Pro anywhere anytime

## WELL-BEING

- Right Purity: many IAQ supporting units from several ventilations to filters
- Easy removal of air filters in each indoor unit for the quicker and regular cleaning to keep your air conditioner clean



## FLEBILITY

- Quicker installation can be achieved by 1. large-capacity yet smaller-footprint and lighter weigh outdoor units 2. both H-LINK & airCloud Tap features can help installers work quickly and efficiently, so that installation work won't cause troubles to the patients
- Flexible combination available with AHU or Ventilation units integrated to VRF system to minimize your initial cost

## SUSTAINABLE GROWTH

- Highest EER max up to 5.40 & specially optimized operation for part-load operation thanks to SmoothDrive 2.0 technology
- Smart monitoring and control: to cut the wasteful energy consumption by each checking status of units from airCloud Pro anywhere anytime

## WELL-BEING

- Right Temperature: Always constant and best cooling
- Right Feeling; airflow control with sensor & original technology + less noise operation!
- Right Purity: many IAQ supporting units

# Adapted to everyone's needs

Features, advantages and benefits at a glance

This table sets out the features and benefits of the air365 MAX range with your needs in mind.



## For Architects

Those who design the building

### EASY TO WORK WITH

Optimize your building by freeing more space from ODU occupied area for the greenery or solar-panel

### DESIGN

- Large capacity yet smaller-footprint units (1.2m<sup>2</sup> for 30HP)
- Require fewer ODUs by IDU connection ratio up to 200%
- Move ODUs to indoor spaces for better building aesthetics
- One solution that works in all ambient conditions

### INCREDIBLE ENERGY EFFICIENCY

Achieve the green building certification by our air365 Max latest cabinets

- Lowering direct environmental impact with air365 Max solution
- One of the world's most efficient VRF solutions: high EER up to EER 5.40
- SmoothDrive 2.0 confirmed for 39% less energy-consumption at 33% part load operation
- Uses 10% less refrigerant in average
- Demand control operation available to achieve forcible entire power saving



## For System Designer (Contractor or Consultant)

Those who design the HVAC solution

### EASY TO WORK WITH

Make your offering more attractive than ever from both initial cost and running cost perspective, by our Easy-to-Work solutions

### DESIGN

- Design faster with airCloud Select
- Large capacity yet smaller-footprint units (1.2m<sup>2</sup> for 30HP)
- Require fewer ODUs by IDU connection ratio up to 200%
- Move ODUs to indoor spaces with EPS up to 80Pa
- One solution that works in all ambient conditions
- Max 200m piping length & max 110m height difference flexibility
- Widest choice of IDUs for any shape of rooms

### INSTALL

- Less communication wiring with H-Link
- Less configuration time by airCloud Tap
- Easier & lower delivery cost by large capacity yet smaller-footprint cabinet

### OPERATE

- Easy for building managers to operate, schedule and automate whole VRF system with airCloud Pro anytime & anywhere
- Easy operation for any end-users by multiple design award-winning remote controllers with user-friendly UX/UI

### MAINTAIN

- Anti-corrosion & gecko-proof cabinet available as options
- Automatic reduction of the risk of failure by compressor rotation control
- Even in case of failure, emergency operation mode backs up
- Patented oil-return control technology leading to more reliable yet comfortable operation
- Quicker and easier maintenance work thanks to airCloud Tap

### INCREDIBLE ENERGY EFFICIENCY

Meeting the top-priority requirement "energy efficiency" of your end user in both rated & part-load operation

- One of the world's most efficient VRF solutions: high EER up to EER 5.40
- SmoothDrive 2.0 confirmed for 39% less energy-consumption at 33% part load operation
- Uses 10% less refrigerant in average



## For Installer

Those who install & service the solution

### EASY TO WORK WITH

Significantly upgraded ease of installation & maintenance by our proprietary technology and solutions

### DELIVER

- Easier delivery and unloading with reduced ODU footprint and forklift support point

### INSTALL

- Less communication wiring with H-Link
- Easier & lower delivery cost by large capacity yet smaller-footprint cabinet
- Unit base holes for safer installation with equipments and piping works
- 4 directions with 9 options for piping connection
- Significantly easier and quicker configuration for both outdoor units & indoor units by airCloud tap of copy-paste setting features

### COMMISSION

- Quicker and easier commissioning, by Service Checker, since it can download continuous operation data for the whole VRF system all at once and create a commissioning report easily

### OPERATE

- Intuitive simplicity designed-in Centralized Controllers airCloud Pro for your easier and quicker operation in case of necessity.

### MAINTAIN

- Significantly faster access to operational data by airCloud Tap without opening the front-cover cabinets



## For End Customer (Investor/Owner)

Those who pay for the system

### SEAMLESS COMFORT

From small spaces to the largest buildings, your preferred living harmony are created

- SmoothDrive 2.0 to keep the constant indoor temperature
- Low-Noise operation available for less trouble to the neighborhood
- Comfort features via supporting IDUs including FloorSense, Crowd-Sense and more
- Several IAQ products available from ventilations to filters & ionizers to keep the indoor air clean and purified

### INCREDIBLE ENERGY EFFICIENCY

Reward you with superior performance as well as significant energy and cost savings

- Lowering direct environmental impact with air365 Max solution
- One of the world's most efficient VRF solutions: high EER up to EER 5.40
- SmoothDrive 2.0 confirmed for 39% less energy-consumption at 33% part load operation
- Uses 10% less refrigerant in average
- Demand control operation available to achieve forcible entire power saving

### EASY TO WORK WITH

Less stress and less expense by our user-friendly controllers and applications

### OPERATE

- Easy for building managers to operate, schedule and automate whole VRF system with airCloud Pro anytime & anywhere
- Easy operation for any end-users by multiple design award-winning remote controllers with user-friendly UX/UI

### MAINTAIN

- Significantly faster access to operational data by airCloud Tap without opening the front-cover cabinets

# OUTDOOR UNITS

## 11 End-to-end solution

- 13 Best-in-class efficiency
- 19 Easy to work with
- 31 Seamless comfort

## 35 Line up (Air Source Cooling Only Type)

## 37 Specifications

- 48 Option / Accessories



## End-to-end solution

For HVAC professionals, architects & building owners looking for a modern HVAC solution that is cost efficient and adaptable, air365 Max is an end-to-end solution that's easy to work from design to installation, operation and maintenance, offering incredible energy efficiency and seamless comfort for users



SmoothDrive technology

airCloud Tap + NFC technology

Gas-injection, Scroll Compressor

Smart Defrost

Oil-return technology

Patented Sigma-shape with patented path structure

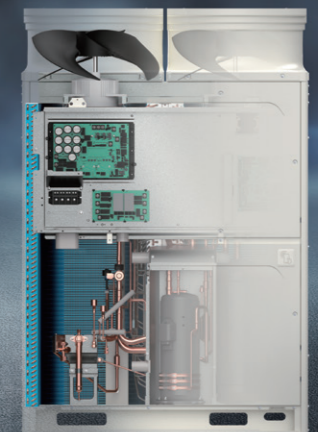

## End-to-end solution



### 1 Best-in-class efficiency

Offers significant improvements in energy consumption thanks to the higher EER & SmoothDrive technology which helps to reduce running costs during part-load operation. This can lead to reduced CO<sub>2</sub> emissions for customers as well.

#### 5 key claims

- All-new heat exchanger and gas injection scroll compressor enables best-in-class VRF energy efficiency up to EER 5.40
- **(Original)** SmoothDrive 2.0 confirmed for 39% less energy-consumption at 33% part load operation
- Uses 10% less refrigerant in average
- Demand Response Enabling Device (DRED) support through both remote controller & centralized controller
- Reduce energy consumption and carbon footprint by 47%

### 2 Easy to work with

A complete solution that saves time and money at every stage of your project, from Design to Maintenance. Our complete ecosystem of indoor & outdoor units, smart apps and hardware features work together as a complete solution.

#### 6 key claims

- [Design] User fewer ODUs with single unit capacity up to 30HP and 200% IDU connection capacity
- [Deliver] Load up to 14% more AC capacity in a single vehicle
- [Install] **(Original)** Up to 4X faster configuration of units with airCloud Tap
- [Commission] Quicker & easier commissioning with Service Checker - get instant reports and visualize detailed operational data
- [Operate] Easy monitoring by airCloud Pro anytime anywhere
- [Maintain] **(Original)** Fast access to error data by using airCloud Tap

### 3 Seamless comfort

Seamless comfort for building occupants, anywhere, anytime. Solves common problems of HVAC solutions including unstable temperatures, cold or hot drafts, direct air, hot and cold rooms during season changes, and more.

#### 4 key claims

- **(Original)** Constant indoor temperature even during part-load operation with SmoothDrive 2.0
- Original & leading-edge technology including GentleCool and CrowdSense, for enhanced occupant comfort
- Neighborhood-friendly outdoor unit with 3dB(A) lower noise output in average by Night Shift Mode in average
- Purifying your indoor air with our affordable IAQ solutions including ViroSense filters and the AqtiV-Ion ionizer kit

# Boost your energy efficiency

With air365 Max, discover how you can make significant improvements in your energy consumption fee.

## High efficiency ratio

- Best-in-class efficiency
- EER up to 5.40

All-new heat exchanger and gas injection scroll compressor enables best-in-class VRF energy efficiency. By installing air365 Max, and you can realize significant energy savings.

Cooling EER



NOTES:  
 1. The graphs above show the EER of single units.  
 2. The above values indicate the EER per outdoor unit when it is combined with specified indoor units.  
 3. The specification of EER of each country is different according to the regulation. Please contact to the Sales person for more information.



## Ideal for Renovation Projects

- Reduce energy consumption and carbon footprint by 47%\*

Our technology is improving every year. Replace outdated HVAC solutions and achieve a 50% reduction in energy consumption and carbon footprint\*

### Electricity consumption reduction

Comparison of (for a system equivalent to 10HP class (28.0kW))  
 Between [RAS-FSN Hitachi inverter VRF of 15years ago]  
 VS [air365 Max RAS-HNCC\*\*]

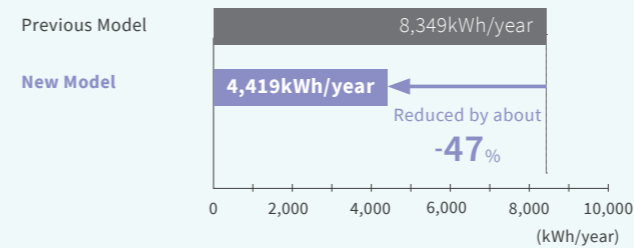

### CO<sub>2</sub> emission reduction

CO<sub>2</sub> emissions  
 (for a 10HP class (28.0kW) equivalent system)

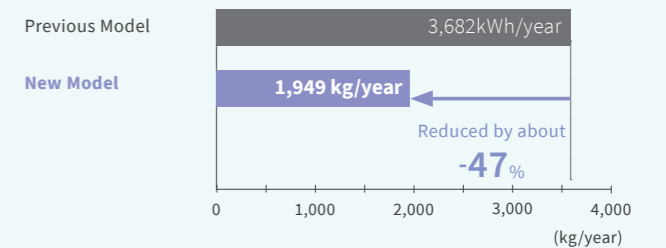

NOTE  
 Condition:  
 1. Both simulation of Seasonal power consumption & CO<sub>2</sub> emissions are a trial calculation value based on JIS B 8616: 2015 (Tokyo office).  
 (cooling: Apr-19 to Nov-11)(Heating Dec-3 to Mar-15)  
 (District; Tokyo) (Application: Office)  
 (AC usage: 6days per week, 8am to 8pm)

2. The CO<sub>2</sub> emissions coefficient is 0.441 kg-CO<sub>2</sub> / kWh. Based on Electric Power Industry Council for a Low Carbon Society in FY20  
 3. As reference in Japanese domestic model

## Less refrigerant required

- Uses 10% less refrigerant in average\*

Compared with our previous generation VRF product air365 Max uses 10% less refrigerant in average & 14.6% less in maximum, helping to reduce the environmental footprint and maintenance costs.

Comparison of (for a system equivalent to 16HP class (45.0kW))  
 Between [RAS-FSNS previous model VRF of 5years ago] VS [air365 Max RAS-HNCC\*\*]

System	Previous top flow VRF	air365 MAX
Initial charge	9.9kg	9.5kg
Additional charge	14.5kg	13.0kg
Total	24.4kg	21.5kg

**-12% refrigerant\* used!**

\* Simulation condition; Comparison between Single 8-28HP class (tier 2) under 95% connection ratio

\*\* Condition:16HP class ODU (45.0kW) \*1  
 3HP class IDU (8.0kW) \* 5  
 Total piping length; 120m  
 IDU connection ratio: 89%

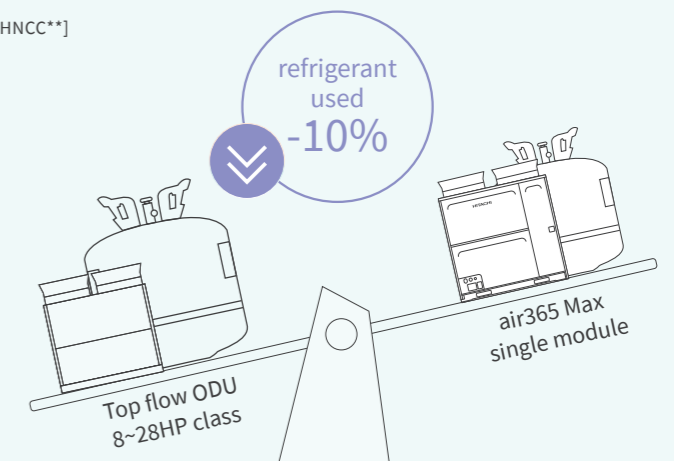



# SmoothDrive™ 2.0 : Superior compressor control

## · Verified 39% less energy-consumption at part-load operation

Most of the time HVAC systems are under part-load because of ambient conditions, set temperature, occupancy and over-specification of the system. As organizations look to improve energy efficiency and reduce carbon footprint by mandating set temperatures within a reasonable range, part-load becomes even more important. Hitachi air365 Max utilizes direct capacity control which combines accurate temperature sensing with precise compressor control to balance load and capacity with less fluctuation. And its effect on energy consumption is verified formally at 3rd party testing facility.

<Testing Condition>  
(at Cooling Operation, Load Factor: Approx. 33%)  
Without SmoothDrive; average power consumption 2.46kW  
With SmoothDrive; average power consumption 1.49kW

---

VRF ODU: (RAS-AP280DG3 = RAS-10FSNS)  
VRF IDU: 4-way cassette indoor units (RCI-AP140K5 = RCI-5.0FSRP)  
Indoor Unit Inlet Temperature: 27°C (Dry Bulb) / 19°C (Wet Bulb)  
Ambient Temperature at Air Volume \*High\*: 23°C (Dry Bulb)  
Piping Length between Indoor Unit and Outdoor Unit: 15m  
Testing Location: Environment Testing Facility at Kansai Denryoku (power supply company)

## VRF air conditioners in buildings experience all kinds of changes during the day...

People coming and going...



Changes in outdoor weather conditions...



Variations in temperature preferences...



## This causes VRF systems to operate at partial load

More than 70% of the time during a year, a VRF System will be running under part-load conditions, with most systems operating at 50% or less of their capacity\*1. These unpredictable part-load conditions cause real-world performance to deviate significantly from official published energy efficiency data.

It's a key reason why your customer may not fully experience all the energy savings they expected from new equipment.

## The simplicity of SmoothDrive

We believe the key to energy efficiency at part load is how generating capacity is controlled. In a normal VRF system this capacity control can be complex, combining both control of refrigerant evaporation temperatures and compressor operation. But at Hitachi Cooling & Heating we've developed a more simple approach called SmoothDrive.

## Why SmoothDrive ?

Part-load conditions cause real-world performance to deviate significantly from official published energy efficiency data. Which is why Hitachi's patented direct capacity control technology delivers...

- real-world energy efficiency**  
Improved energy efficiency under part-load operation, which regulatory energy efficiency ratings do not account for.
- temperature stability**  
With continuous monitoring and adjustment of the capacity based on compressor speed, indoor temperatures can be maintained more accurately.
- smoother compressor operation**  
Compressor rotation frequency is more precise and stable. On/Off cycles are reduced, while peaks and drops are diminished, reducing wear on the compressor.

## Real-world energy efficiency\*\*

Improved energy efficiency under part-load operation, which regulatory energy efficiency ratings do not account for

### COP in Cooling mode

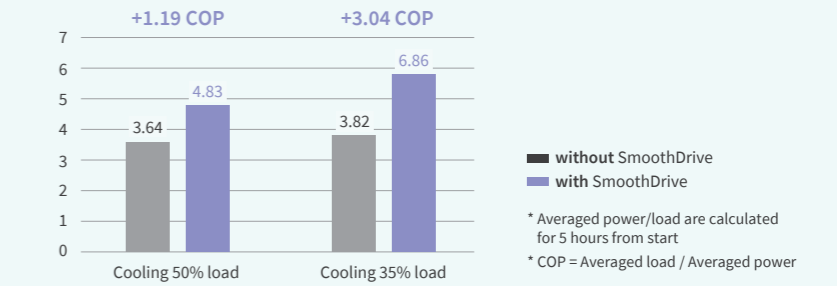

## Temperature stability\*\*

With continuous monitoring and adjustment of the capacity based on compressor speed, indoor temperatures can be maintained more accurately

### Cooling 50% Load

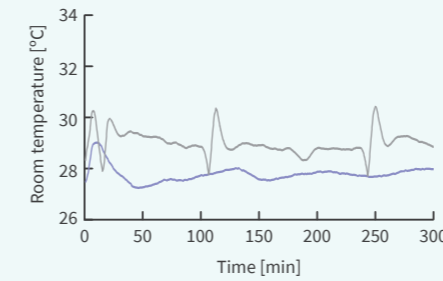

### Cooling 35% Load

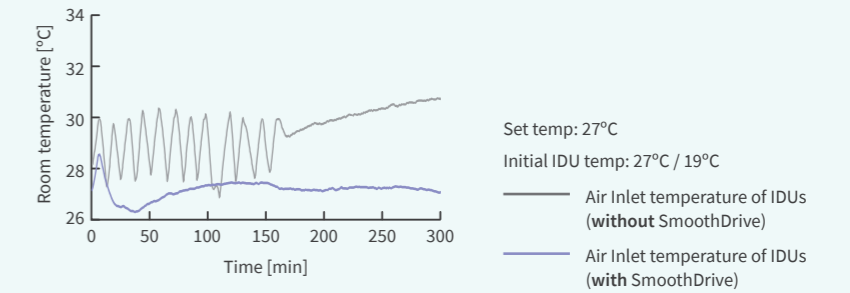

## Smoother compressor operation\*\*

Compressor rotation frequency is more precise and stable. On/Off cycles are reduced, while peaks and drops are diminished, reducing wear on the compressor.

### Cooling 50% Load

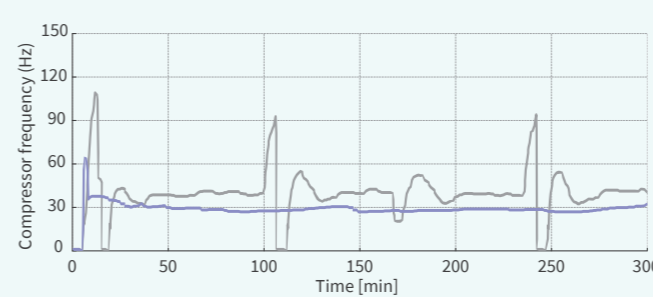

### Cooling 35% Load

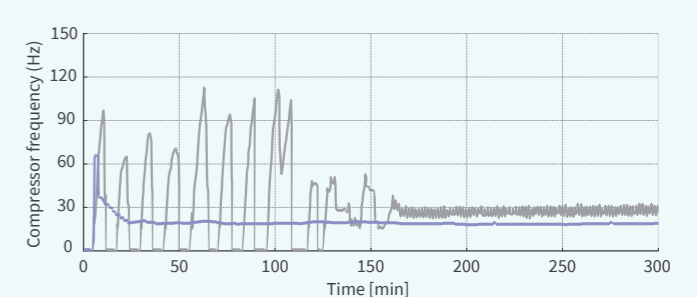

\*\* Outdoor Unit; 10HP class. Indoor Unit: 5HP Class 4-way cassette unit \* 2 pcs. In our own company's fixed-load testing facility (Dimension of the room per one indoor unit : 5.6m×2.5m×3.1m). Outdoor temp (DB / WB): 29°C / 19°C. Load per room (Sensible / Latent): 4.9kW / 0.0kW. Set temperature: 27°C. Initial indoor unit temperature (DB / WB) : 27°C / 19°C. Indoor unit fan airflow rate: HI-mode.

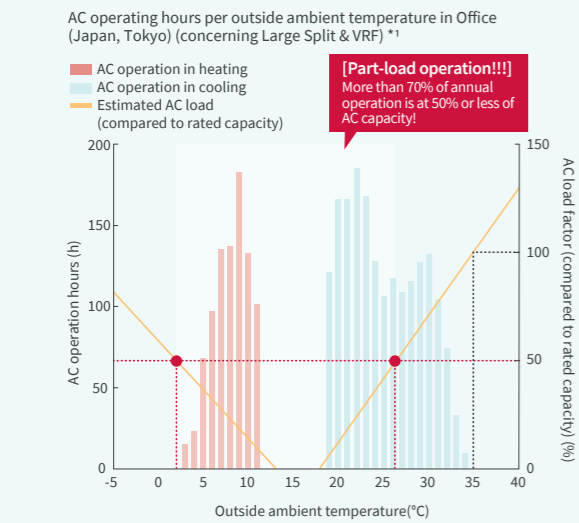

\*1. JIS B 8616:2015 (Japanese packaged air conditioners standard) to arrange the performance test for the system.

QR Please refer to the leaflet for details

Add YouTube video or SmoothDrive brochure link

## Demand control

- Manage your electricity during peak periods
- Peak-cut Control
- Moderate Control

A Demand Response Enabling Device (DRED) air conditioner allows your electricity provider to control the system at various pre-programmed levels, to manage your demand on the power grid during peak periods.

The aim is to reduce overall power consumption to the supply network at critical peak load times.

This feature can be enabled and disabled on an individual or centralized Hitachi controller. No additional equipment is required.

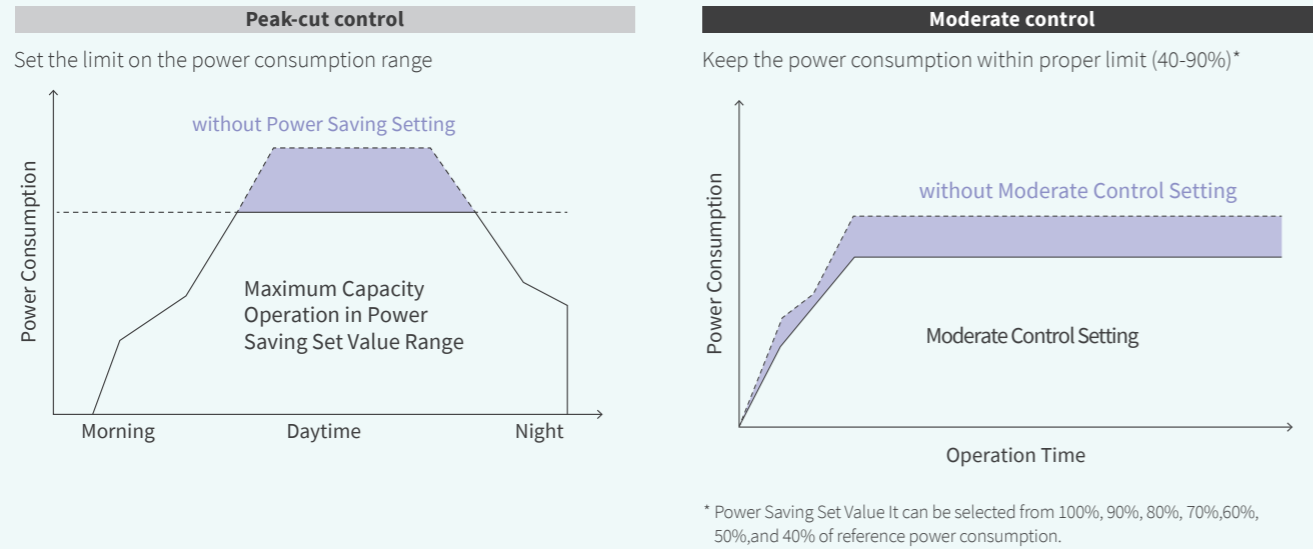

## Better energy saving operation (Motion Sensor Control)

- Compatible internal units (IDUs) can automatically detect occupancy and automate operation accordingly

The presence sensor makes it possible to control operation based on the persons present in the climate controlled space.

If the VRF unit is installed in a room in which the presence of persons is not constant, the sensor makes it possible to automatically control operation in such a way as to reduce consumption and achieve energy savings.

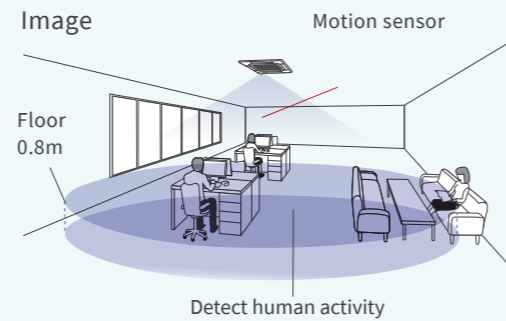

### Automatically saves ability by detecting the amount of human activity

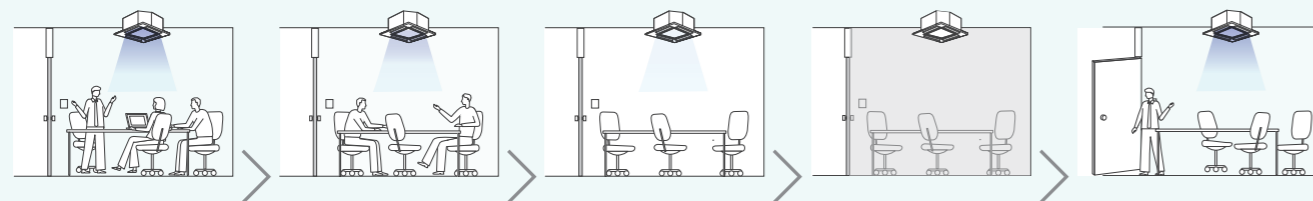

**Standard operation**

In a room with a lot of people moving, standard operation

**Save Power**

Moderate air conditioning when there is little movement of people

**Save more**

When there are no people for a certain period of time, the air conditioning is even more modest

**Forgetting to turn off**

If the absence continues for more than 30 minutes, the operation can be stopped by setting

**Resume**

Resume standard operation when people return

## Lowering direct environmental impact

- Complied Regulation

"Localize Contents" [ ]

- Eco-friendly packaging

Our unit packages are all designed for easy disposal  
ODU: Wood/Paper packaging only  
IDU: Classification marks for easier recycling of plastic

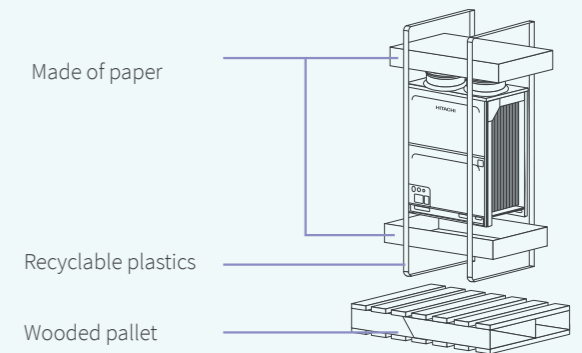

# A complete solution at every stage

From design to installation, operation and maintenance, air365 Max is here to make your work easier.

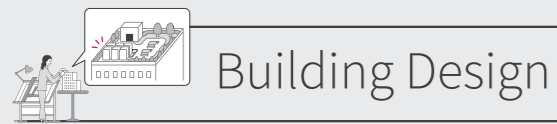

## Larger capacity, smaller footprint

- Single module capacity up to 30HP per unit
- Up to 36% smaller cabinet footprint\*
- Maximum combination up to 120HP
- Maximum IDU connection ratio up to 200%
- Supports vertical stacking of ODUs to save space

Lower initial cost through faster and easier installation  
Occupies less space in buildings, rooftops or balconies  
Enables more real estate for greenery or photovoltaic systems

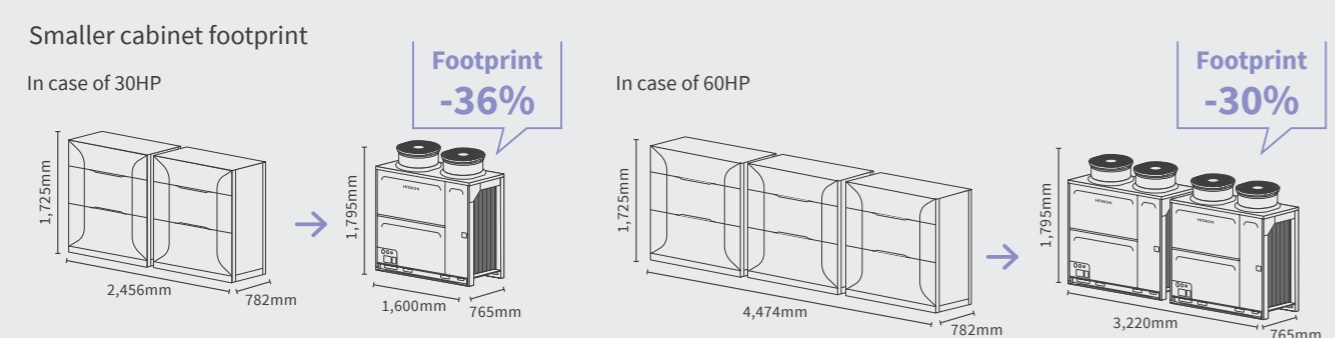
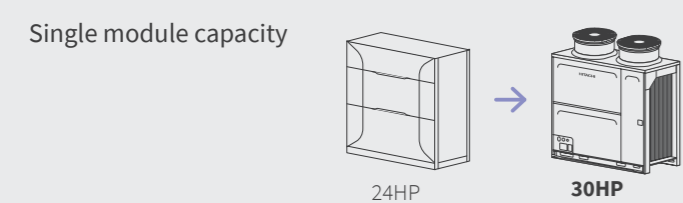

Thanks to 200% IDU connection ratio

In case that IDU total capacity are 52HP

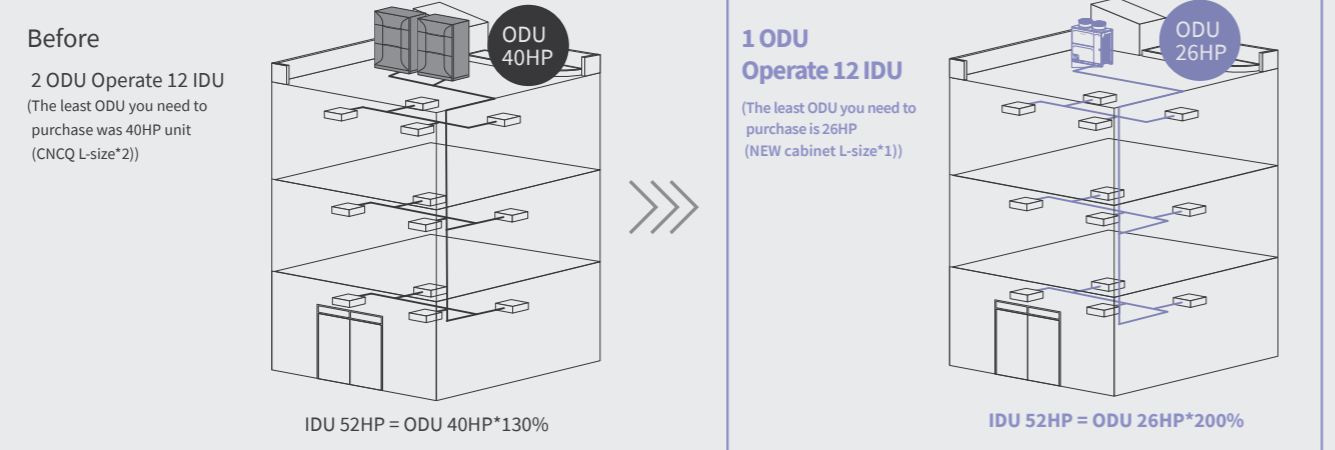

Thanks to large capacity & installation flexibility

In case that ODU total capacity is 320HP

16 units on the roof

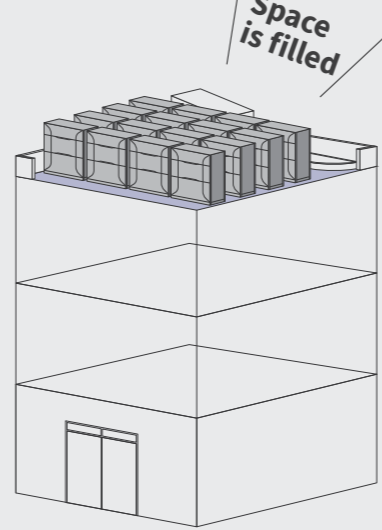

12 units on the roof (Larger Capacity but Smaller units)

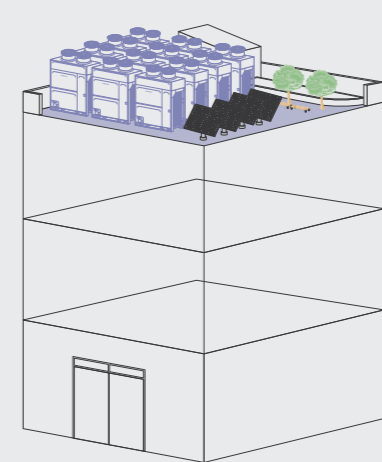

Point 1  
Effective use of space, such as rooftop greenery and solar panel installation

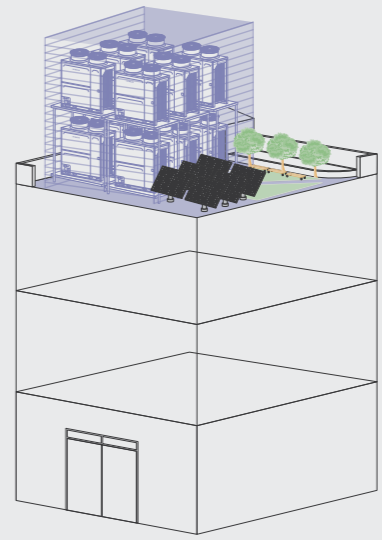

Point 2  
Vertical installation is available now to save the ODU occupied space almost half

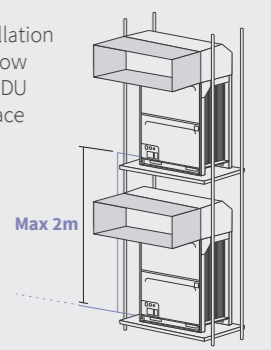

NEW

## High external static pressure (ESP)

- Total 4 steps of ESP
- Maximum up to 80Pa

The High External Static Pressure (ESP) setting for air365 Max units enables them to be located inside ventilated machine rooms, rather than just outdoors. This may reduce installation costs as well as reducing impact on the external facade of the building.



UP TO 80Pa

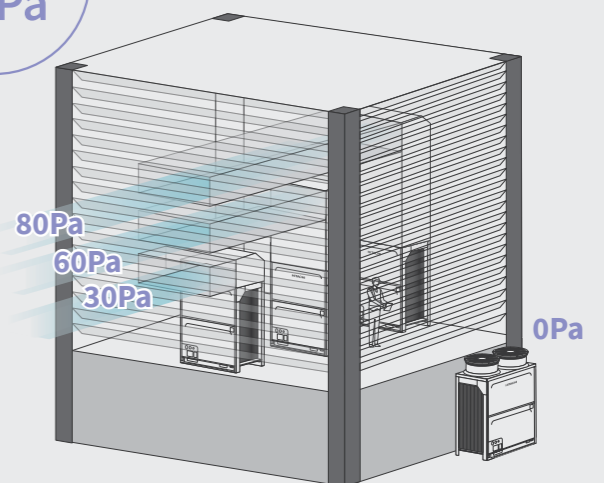

# System Design

## More flexible piping configuration

- Maximum piping length up to 200m
- Maximum height difference up to 110m

Longer pipe runs and greater height differences enable more flexibility for use in retrofit or renovation projects. Supports installation in high-rise buildings. Depending on building design, enables location of all units on the rooftop for faster installation and easier maintenance. Enables more discrete placement further away from visual and noise sensitive spaces.

< For 4 Units Combination >

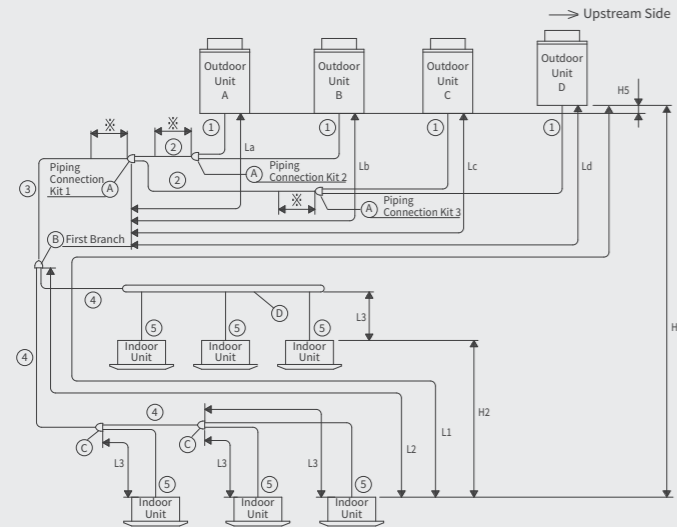

\* Keep the straight line distance of 500mm or more after the piping connection kit.

			Mark		
Total piping length	Between ODU and IDU	Actual	m	1,000	-
		Equivalent	m	225	L1
Maximum piping length	Between "Piping connection kit" and each ODU single module		m	25	La, Lb, Lc, Ld
	Between "1st branch Multi Kit" and farthest IDU		m	100	L2
	Between "Multi Kit" and each connected IDU		m	40	L3
Maximum height difference	Between each single module of 1 ODU		m	2	H5
	Between ODU and IDUs	ODU above IDU (*)	m	110 (50)	H1
		IDU above ODU (*)	m	110 (40)	H2
	Between IDUs		m	40	H2

Note: Some restrictions would be applied when the height difference between outdoor units and indoor units are [50m or more in case outdoor unit is higher] and [40m or more in case outdoor unit is lower]. Please refer to technical manual for details.

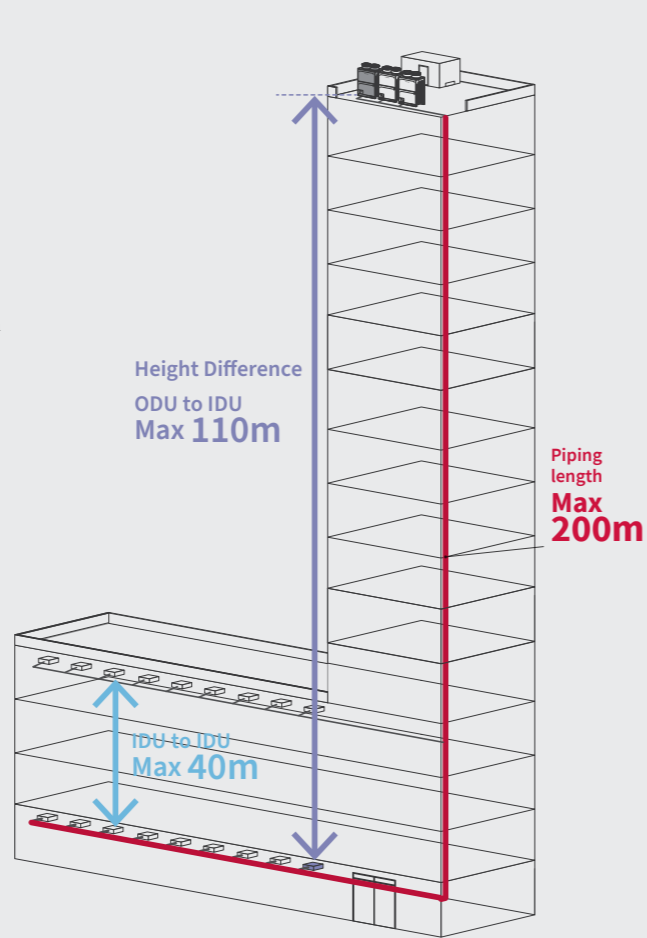

## Widest choice of indoor units

- Total 18 types
- Design award winning design

With more than 100 different indoor units to choose, air365 Max supports a wide range of building layouts and interior design requirements. Includes units that can be hidden to suit indoor aesthetics. Exposed units that minimize installation costs. Best balance of cost and aesthetics can be supported by the unique Silent-Iconic 4-way cassette panel.



## Anytime & Anywhere

- Cooling in 52 ~ -10°C
- Normal operation even under up to 60m/s
- JRA anti-corrosion treatment available

Because we live in a diverse and changeable world, our air365 Max units are designed to operate faultlessly in any climates and weather situation.

### Summer temperature

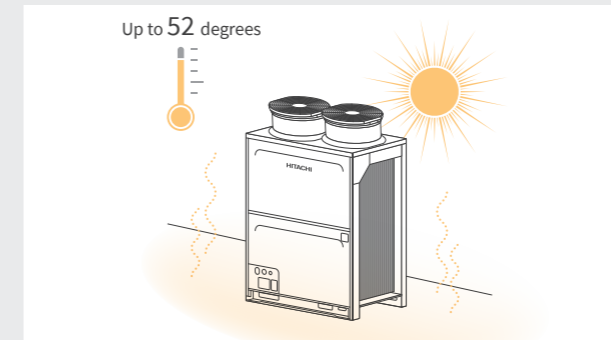

### Cooling operation from up to 52°C ambient temperature

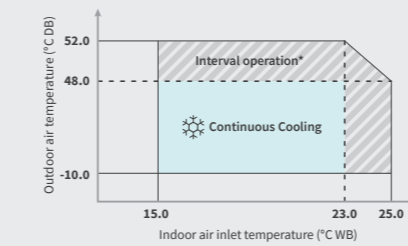

\*Only in the case where the outside temperature (outdoor unit air inlet temperature) rises temporarily due to, for example, the installation condition, the system can be used at a temperature up to 52°C.

### Wind-proof cabinet

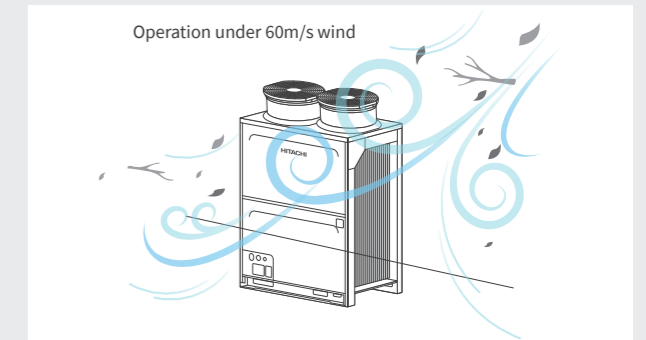

Test machine: RAS-FSNS (confirmed that it has the same structure and has the same durability of air365 Max)  
 Test conditions: Experiment of blowing wind equivalent to 60m/s  
 Test results: Operation is possible with no scattered parts or cracks in the refrigerant pipes.  
 Assessment site: by Large fan at Tsukuba Techno Center of Ryuki Engineering Inc.

### Anti-Corrosion Cabinet + Gecko-proof treatment

If your project is located in an extreme weather environment, consider applying an anti-corrosion treatment to your air365 Max outdoor units. Treatment can be arranged in factory based on the JRA9002 standard, with multiple layers on every component of the unit. With this treatment, the life expectancy in marine salty-air environments can be doubled. It is also effective against lizards/geckos.



\*Considered JRA9002: Criteria and Testing of Corrosion-proof for Refrigeration and Air Conditioning Equipment against Salty Air  
 \*Please consult Hitachi distributors for more details  
 \*Both "Anti-corrosive treatment" and "Heavy anti-corrosive treatment" are by custom order

### Corrosion Resistance

Life-expectancy comparison In salty-air-location

Standard	Life-expectancy
Standard	1x
Anti-corrosive Treatment Custom Order	2 times longer!
Heavy anti-corrosive Treatment Custom Order	2 times longer!

Corrosion-resistance improved Heat Exchanger

3 Coating Layers

- Hydrophilic Resin Film
- Corrosion-Resistance Resin Film
- Phosphoric Acid Chromate Treatment
- Aluminum Fin

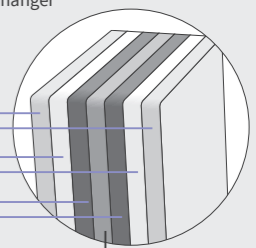



## System Design



reddot winner 2022  
interface design

### airCloud Select

• “airCloud Select” is the new software created by Hitachi to help you quickly finish the unit selection for your VRF design project.

- Enjoy a super intuitive and modern interface
- Select the suitable VRF equipment for each project
- Generate automatic report for your customers



airCloud Select is available upon request. Availability varies per country. For more information, please contact your Hitachi Cooling & Heating representative or visit [www.hitachi-aircon.com](http://www.hitachi-aircon.com)

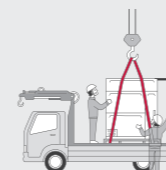

## Delivery

### Easier delivery

• Load up to 14% more AC capacity in a single vehicle

Our air365 Max units are designed to work in harmony with your outdoor and indoor spaces. Lighter and smaller than ever before, they are easier and cheaper to transport.



#### Container

#### In case of 40ft container

Now air365 Max: L cabinet up to 28HP class) can be loaded by 14pcs  
Previously, L cabinet (RAS-FSNS/CNCQ) was up to 24HP class  
So, just simply if it is the comparison of single module combination, 14% more load.

#### Before

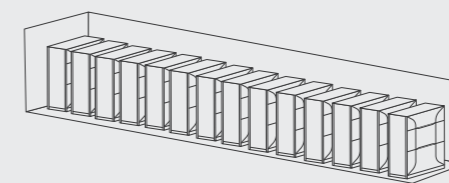

$$24\text{HP} \times 14 = 336\text{HP}$$

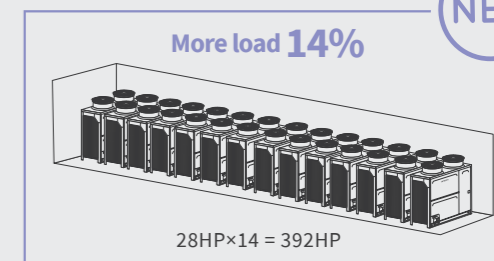

$$28\text{HP} \times 14 = 392\text{HP}$$



#### Truck

#### In case of 10ft van

L size up to 10pcs  
So, previously, 80HP cabinet (LLLL) \*2, and 48HP cabinet (LL) \*1 was full of 10ft van.  
Now air365 Max: 80HP cabinet (LLL) \*2, and 48HP cabinet (LL)\*1 is not FULL yet  
You can have another two cabinet of LL too! So even same capacity, but still 20% more space left!!!

#### Before

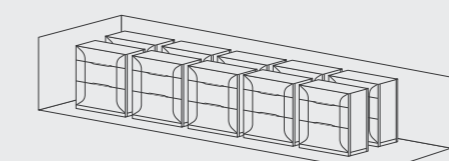

$$80\text{HP (LLLL)} + 80\text{HP (LLLL)} + 48\text{HP (LL)} = 208\text{HP}$$

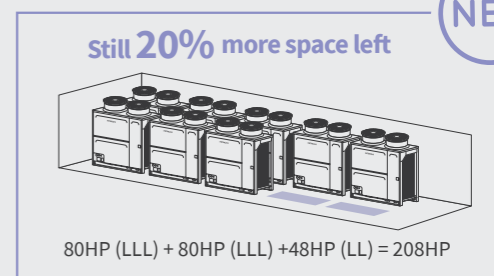

$$80\text{HP (LLL)} + 80\text{HP (LLL)} + 48\text{HP (LL)} = 208\text{HP}$$

### Safer unloading

- The holes for hanging by Sling belt by crane trucks
- The holes for the hand/fork lifters

New cabinet design features more holes for forklifting or craning  
Center holes are for forklift trucks or hand-lifters  
Outer two holes are used for sling belts to lift the units with a crane

- ① Package shows the part to be hung by lifting cranes too
- ② In case of forklift or handlifer, even without pallet, there is a special hole to be transported

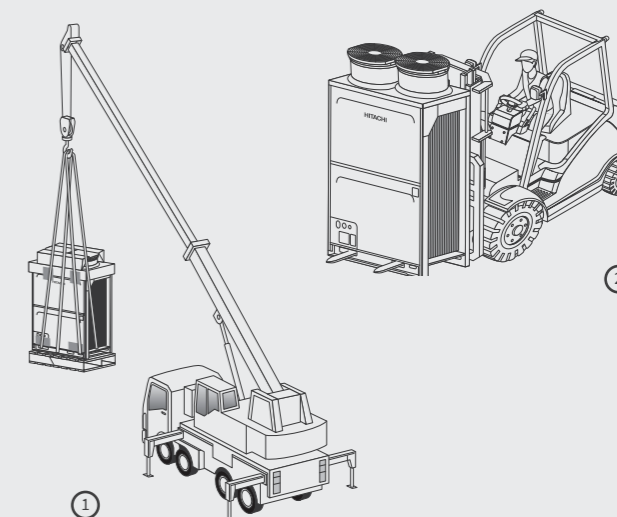

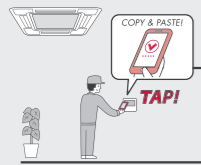

# Installation

## Easy delivery with holes

- 4 different types of all delivery can be easily arranged

Our air365 Max units are designed to work in harmony with your outdoor and indoor spaces. Lighter and smaller than ever before, they are easier and cheaper to transport.

Package shows the part to be hung by lifting crane too

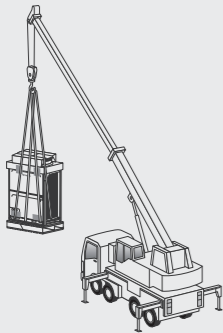

In case of forklift or handlifer, even without pallet, there is a special hole to be transported

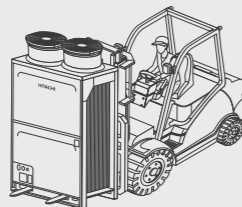

Mobile deck can be supported by the frat bottom part



Large yet small footprint cabinet >> fit in the lift

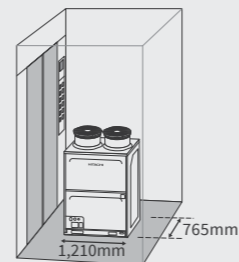

## Choice of piping direction

- 4 directions, 9 options

To make the installation as easy as possible, air365 Max unit can be piped from the front and base of the units via 9 different piping options. Bottom piping connection is large enough for refrigerant piping with standard insulation.

Front

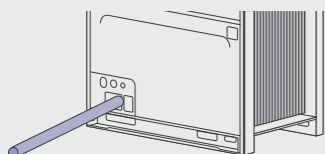

Back

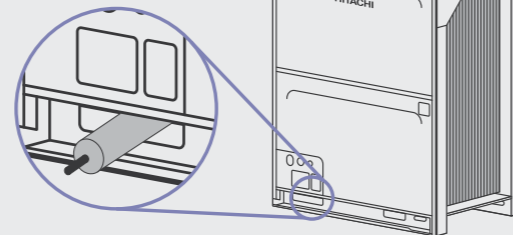
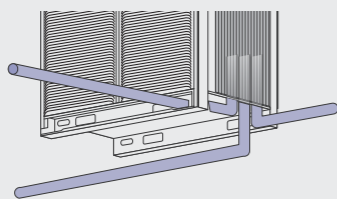

[Front]

- Through the piping port on the front panel cover
- Through the Unit base hole

[To the right]

- Through the piping port on the front cover
- From bottom of the cabinet
- Through the Unit base hole

[To the left]

- Through the piping port on the front cover
- From bottom of the cabinet
- Through the Unit base hole

[To the rear]

- Through the Unit base hole



## H-LINK: flexible route of communication wiring

- Faster wiring with H-LINK

Hitachi H-LINK is a powerful, proprietary communication system that lets you control multiple outdoor and indoor units from one control point. For installers and service engineers, H-LINK simplifies the whole building wiring works by enabling units to 'daisy chain' together - making wiring connections from the closest available unit, regardless of the type. This can reduce installation time and costs.

H-LINK

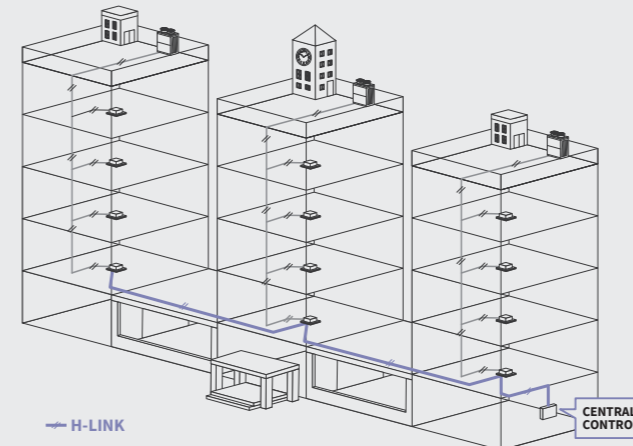

Company A

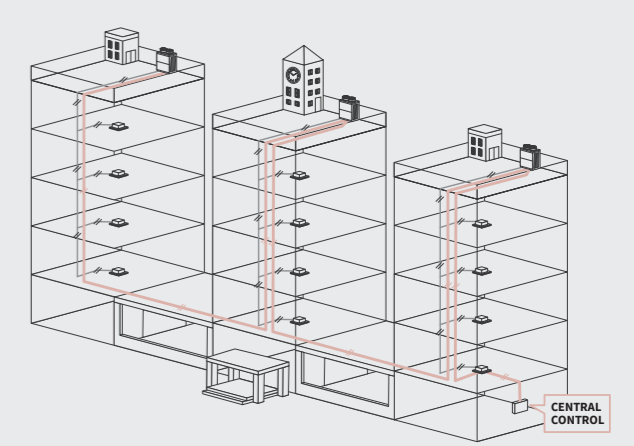

- ODU configuration: 4X faster
- IDU/controller configuration: 2X faster

Faster configuration using our patented airCloud Tap mobile app and NFC (Near-field communication) technology embedded in the outdoor unit and individual controllers

All settings are available with convenient descriptions inside the phone app

Operators can 'copy and paste' settings for one ODU (or IDU via individual controller) to multiple units using their phone

Ideal for hotels, classrooms, businesses with multiple meeting rooms or large buildings with multiple VRF outdoor units installed

Download airCloud Tap!



### 76% time reduction (ODU configuration)

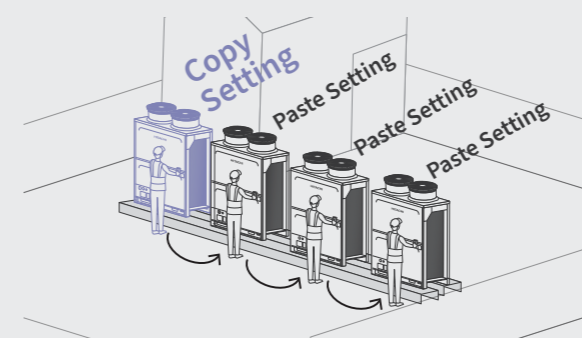

- 1) Conventional way to open and close the cover and manipulate dip/power switch: >>> takes 40min 40sec
  - 2) By using airCloud Tap without opening the cabinets: takes 9min 40 sec [Simulation scenario]
- total 4 ODUs initial setting
  - total 5 items setup; ODU number, Refrigerant cycle number, Higher ESP setting, Power Supply setting, and Compressor manual-off setting.

### 53% time reduction (IDU + CTRL configuration)

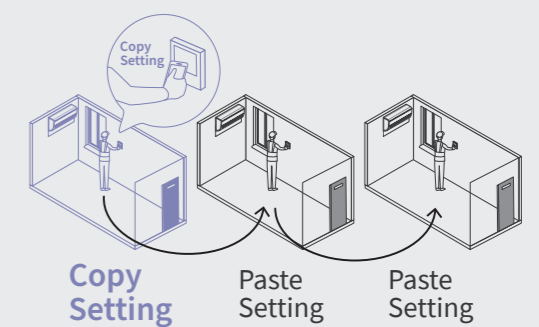

- 1) Conventional way: takes 103min 16sec
  - 2) By using airCloud Tap: takes 47min 40 sec [Simulation scenario]
- Total 20 controller setting
  - Total 7 items of setup: Room name, Time, Language, Temperature unit, Backlight of the screen, Operation schedule from Monday to Friday 08:30-18:30 28°C, Upper and lower limit of setting temperature for cooling

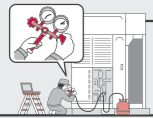

## Commission

### Service Checker

- Quicker & easier commissioning

Service Checker is a dedicated service device for HVAC technicians. It can connect to the ODU PCB to download continuous operation data for the whole VRF system and create a commissioning report easily.

#### Key features

- Display and storage of all operation data
- Graphical visualization of operation data
- Rapid report creation
- Access to all unit settings/configuration

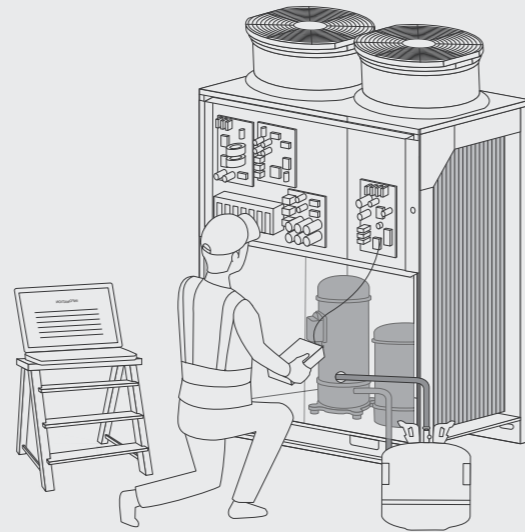

## Operation

### Monitoring app **airCloud** Pro



- Control is in your hands. 24/7 control at your fingertips on smartphone, tablet, or PC.

**For stand-alone and multi-site applications.**



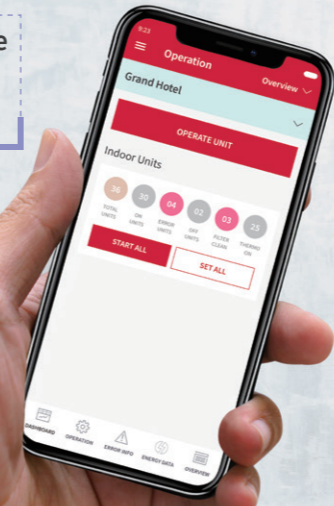

✓ **Intuitive simplicity**

airCloud Pro is designed to make your job easier. An intuitive app that anyone can use, airCloud Pro makes managing your VRF systems easier than ever before.

✓ **Control from anywhere**

Enjoy the freedom of remote access from your smartphone, tablet or laptop. airCloud Pro allows you to remotely control your VRF system(s) from a single app, saving you travel time.

**Localize (add YouTube link at your side)**

### Individual controllers **PC-ARFG1 / PC-ARC**

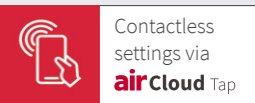

- A new generation of room controllers with User friendly UX/UI

#### ADVANCED-COLOR CONTROLLER (PC-ARFG1-\*)



##### Complete controls in a rich interface

- Colored screen displaying visual charts and descriptive texts
  - Access to all existing Hitachi VRF indoor unit features including user features settings, installation & maintenance features settings.
  - Energy consumption monitoring
  - Ideal for indoor units with motion sensors, cassettes with elevating grilles
  - Multiple languages available
- \*Except Sleep Mode timer



reddot winner 2021



**Localize (add YouTube link at your side)**

#### ECO-COMPACT CONTROLLER (PC-ARC-\*)



##### Value without compromise

- Segment screen displaying pictograms
- Essential controls in a glimpse
- On/Off weekly schedule
- Some extra advanced features such as GentleCool, Power-Saving Peak-Cut mode and Sleep Mode Timer
- Embedded IR receiver, ideal for ducted units

**Localize (add YouTube link at your side)**



# Maintenance

## Compressor rotation control

- Extend ODU lifecycle

manages equal loading on multi-compressor configurations, ensuring equal lifespan of each compressor in the system

### Compressor rotation frequency control (example)

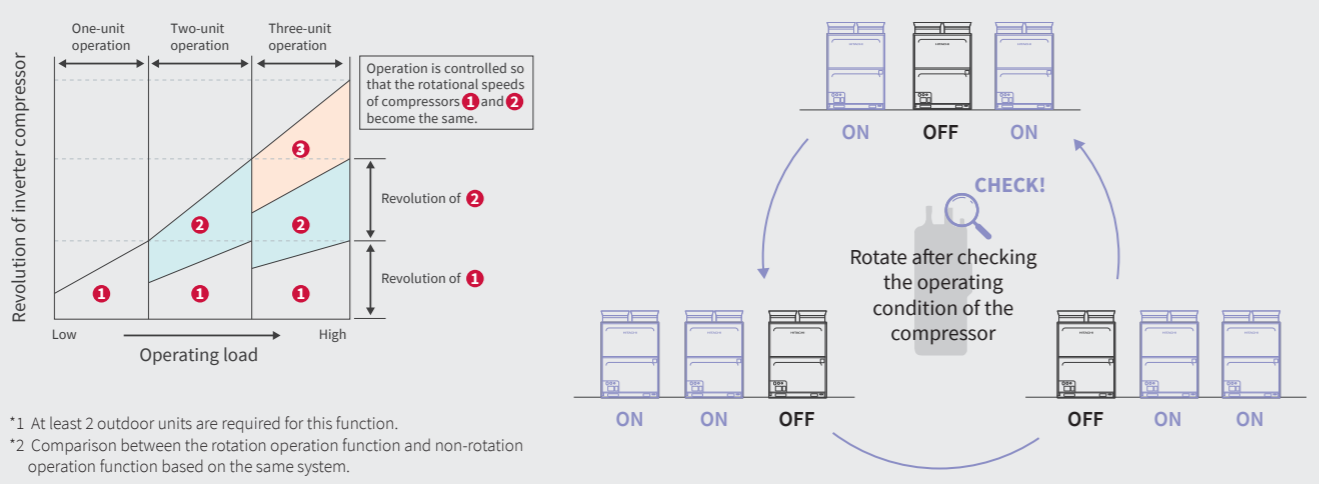

\*1 At least 2 outdoor units are required for this function.  
\*2 Comparison between the rotation operation function and non-rotation operation function based on the same system.

## Emergency operation mode

- Continue HVAC operation in the event of a unit failure

In multi-unit installations, the Backup Operation Function prevents the system from coming to a complete stop if an outdoor unit failure occurs. If one outdoor unit should fail, the system can continue to operate using the remaining outdoor units. Emergency operation can be performed up to 8 hours after unit stoppage.

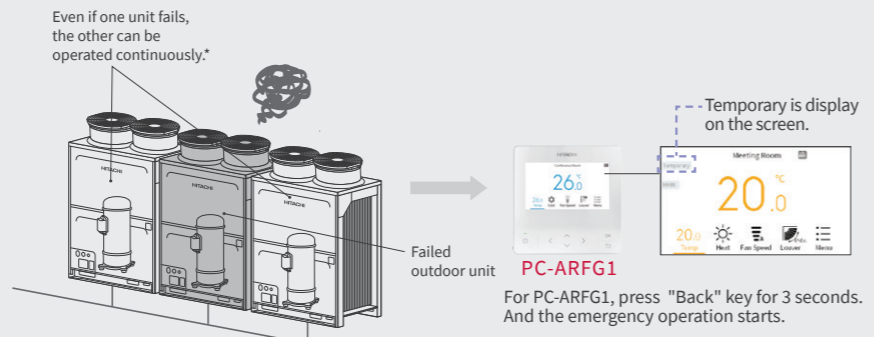

\* Emergency operation can be performed within 8 hours after unit stoppage. Emergency operation cannot be performed when 8 hours have elapsed since unit stoppage.

## Oil-return control

- Patented oil control for lower noise and higher energy efficiency

As well as reducing lubricating oil loss, this patented oil return control cycle consumes less energy and produces much less noise—resulting in higher efficiency and greater comfort for occupants

- Every hour, oil-return operation activates for just 60 seconds (cooling mode)
- During oil return mode, indoor units can continue to operate normally

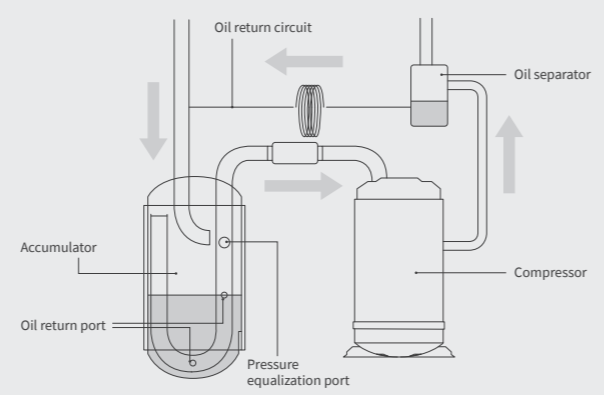

## airCloud Tap for faster maintenance



- 6X faster access to unit operational data\*
- 80% time reduction (ODU data check)

Previously, a maintenance engineer would need to open both the front panel of the cabinet and electricity box panel, then check error codes on the PCB.

Now with the airCloud Tap app, an engineer can simply 'tap' the outdoor units with their smartphone to access a full range of configuration settings and download operational data if required for basic troubleshooting.

No need to open the panel to check simple data anymore!!!

The technology is also embedded in individual controllers enabling access to indoor unit settings.

### Before

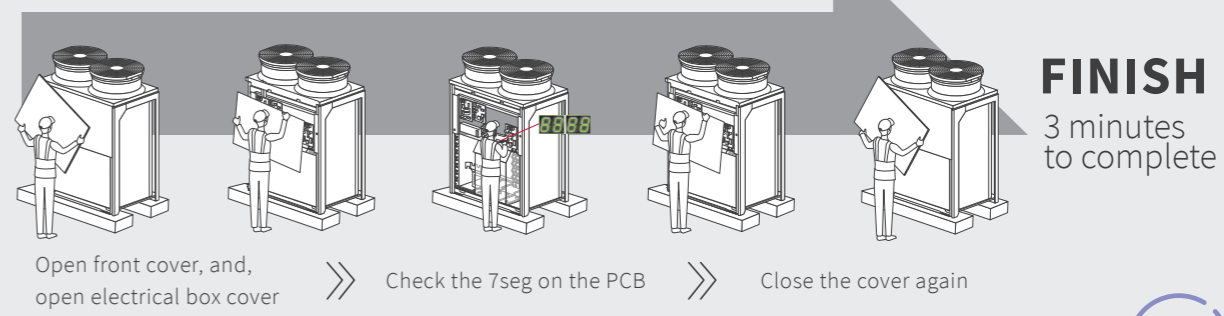

### NEW

Using the airCloud Tap, operate the app, touch the ODU, and obtain the data >>> total 30sec

**FINISH 30 seconds to complete**

Note.  
Test simulation scenario: Check the alarm cause [Previously] open up the cabinet panel, open the electricity box cabinet panel, check the 7segment of the PCB, then, close the two cabinet panels. >>> minimum takes 3min [Now] just activate the airCloud Tap application, and, operate the screen, and TAP the outdoor unit and obtain the data >>> takes 30sec!

## Powerful support app for your quick configuration & maintenance

Available on the App Store

ANDROID APP ON Google Play

Localize (add YouTube link at your side)



# Enjoy the perfect air anywhere, anytime

## Indoor comfort

### GENTLECOOL

- Prevents cold drafts all the time

When starting up air conditioners can discharge very cold air to quickly reach the required temperature for the room, but this can result in cold drafts making occupants uncomfortable. With GentleCool you can adjust the balance between achieving a lower room temperature quickly and avoiding cold drafts. Because you can now set your preferable WIND temperature, as well as ROOM temperature.

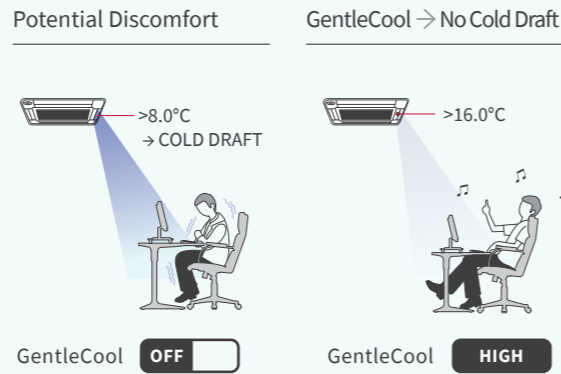

### DIRECT/INDIRECT CONTROL

- Occupants can choose whether they want to directly feel airflow

The presence of occupants is detected through a motion sensor which divides the room into 4 zones – one for each louvre. For each of the 4 zones served by a cassette, air can be served either Direct or Indirect. Therefore one zone could receive direct airflow while another has indirect airflow.

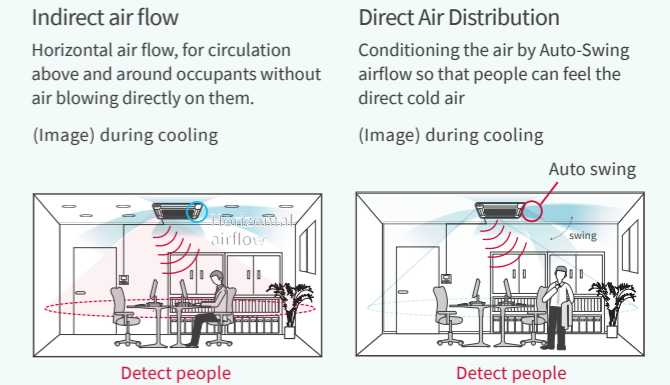

### CROWDSENSE

- Maintains a stable temperature as the number of occupants change

With CrowdSense technology, our VRF cassette units can determine how many people are in a space and adjust the cooling capacity accordingly, so the room will never get too hot or cold, whether it's crowded or almost empty.

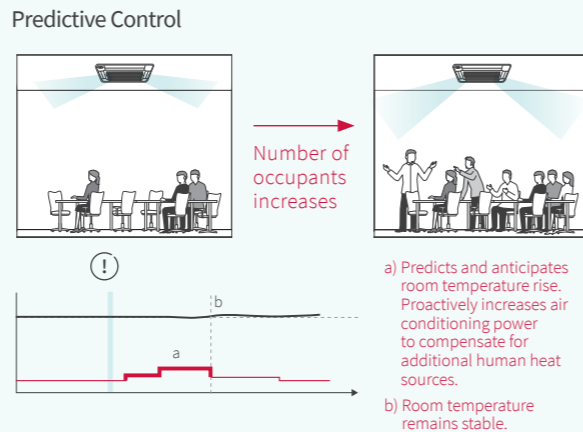

### HOTEL SETBACK

- Interlocks with hotel key card to automate operation based on guest entry

Hotel Setback temperature with interlock to key card reduces AC operation when the guest leaves but maintains room temperature within a comfortable range. Win-win feature for both hotel guests & hotel managers to achieve Comfort-satisfaction & energy saving operation.

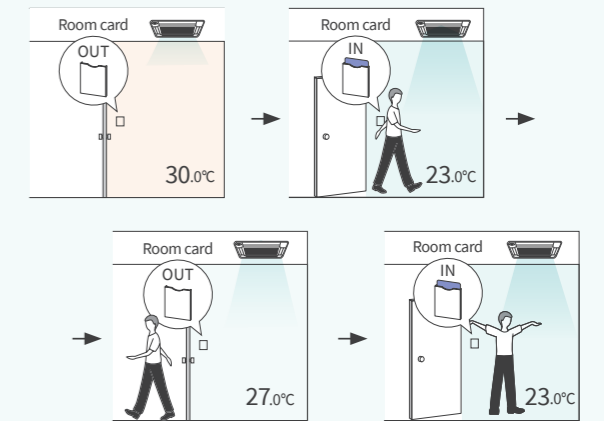

### FLOOR-SENSE COOLING

- Prevents over-cooling of the floor area in cooling mode

In cooling scenarios, FloorSense Cool can prevent the floor area from overcooling by controlling airflow and cooling capacity so that the air at floor level does not get as cool as air above knee height.

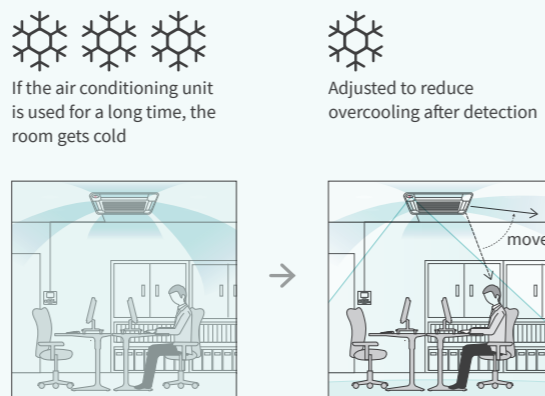

## Low Noise Operation

- Neighborhood-friendly outdoor unit with 3dB(A) lower noise output\* in average

Balance is the key to harmony, so air365 Max incorporates features to ensure a more peaceful environment, both indoors and out. Enjoy quiet comfort indoors with less disturbance to the outside environment. You can set this feature from your individual controller easily.

#Normal Sound Pressure (SPL) in Full Anechoic VS #Night-shift mode (SPL) in Full Anechoic  
Average -3.0dB(A)  
Reference: Architectural Institute of Japan "Sound insulation performance standards and design guidelines for buildings"

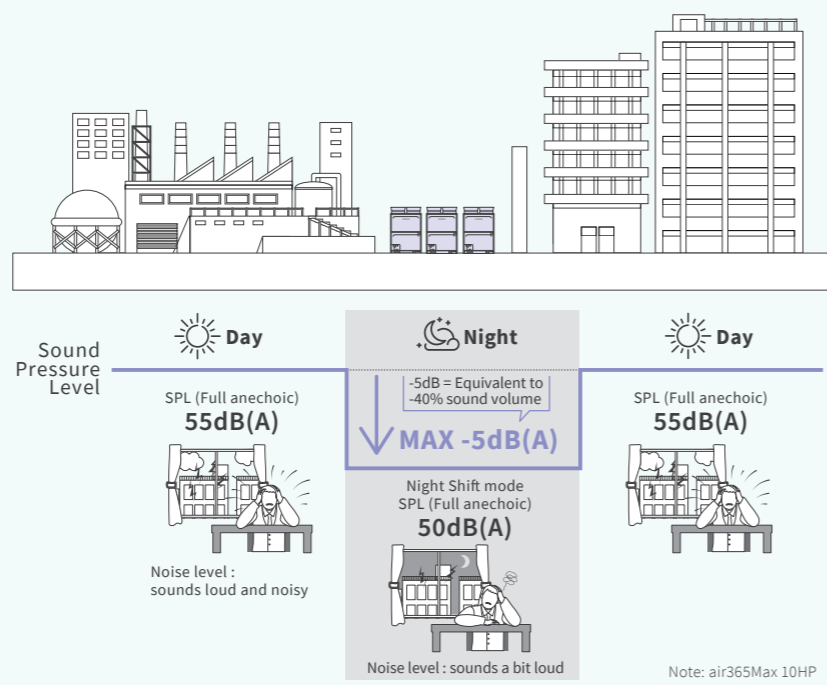

## DIRECT capacity control SmoothDrive™ 2.0

- Constant indoor temperature even during part-load operation

With continuous monitoring and adjustment of the capacity based on compressor speed, indoor temperatures can be maintained more accurately.

Localize (add YouTube link at your side)

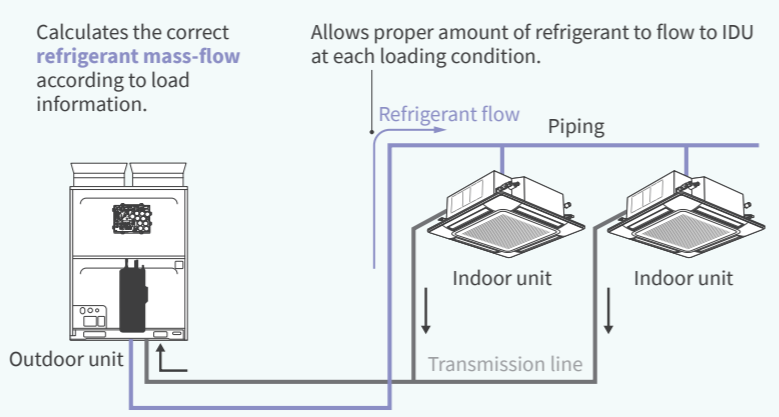

- SmoothDrive helps the scroll compressor to run continuously and smoothly even at part-load condition.
- Our original load-speculation technology helps reduce energy loss caused by scroll compressor switching on/off.
- Consequently, constant room temperature & energy savings can be achieved.

### 50% Load

#### Cooling Mode

Set temp: 27°C  
Initial IDU temp: 27°C / 19°C

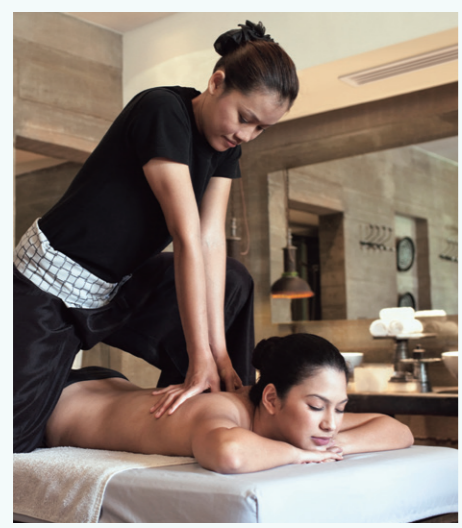
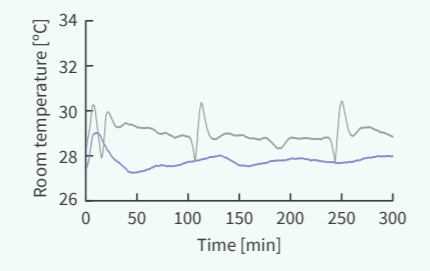

\* Outdoor Unit; 10HP class. Indoor Unit: 5HP Class 4-way cassette unit \* 2 pcs. In our own company's fixed-load testing facility(Dimension of the room per one indoor unit :5.6m×2.5m×3.1m). Outdoor temp (DB / WB): 29°C / 19°C. Load per room (Sensible / Latent): 4.9kW / 0.0kW. Set temperature: 27°C. Initial Indoor unit temperature (DB / WB) : 27°C / 19°C. Indoor unit fan airflow rate: HI-mode.

## IAQ matter

### ViroSense S filter

#### Our standard VRF filter has been upgraded to ion technology

Contains a silver ion that is released in the presence of moisture, binding to cellular enzymes of microbes and inhibiting enzyme activity of the cell wall, membrane, and nucleic acids.  
Anti-virus (>99% inhibition) / Anti-bacteria (>99% inhibition) / Anti-mold (100% growth stop)

#### Standard-equipped filter ViroSense S filter



#### BENEFITS

<p><b>ANTI-VIRUS</b></p> <p>over 99% Inhibition</p>	<p><b>ANTI-BACTERIA</b></p> <p>over 99% Inhibition</p>	<p><b>ANTI-MOLD</b></p> <p>100% growth stop</p>
-----------------------------------------------------	--------------------------------------------------------	-------------------------------------------------

### ViroSense Z2 Filter

#### This optional filter can help to reduce the risk of secondary SARS-CoV-2 infections in a room

Contains Zinc Ion - in the presence of moisture it is able to bind to virus and bacteria and inhibit.  
Anti-virus (>99.7% inhibition) / Anti SARS-CoV-2 (>99.9% inhibition) / Anti-bacteria (>99% inhibition)

#### Optional accessory filter ViroSense Z2 Filter



#### BENEFITS

<p><b>SARS-CoV-2 Inhibition by over 99.9%</b></p>	<p><b>Virus Inhibition by over 99.7%</b></p>	<p><b>Bacteria removal by over 99%</b></p>	<p><b>Life span of up to 4 years</b></p>	<p><b>Quick anti-virus transformation</b></p>
---------------------------------------------------	----------------------------------------------	--------------------------------------------	------------------------------------------	-----------------------------------------------

### AQtiv-Ion Kit

#### AQtiv-Ion Kit for Ducted units

- Easily installed in a VRF ducted indoor unit
- A low-maintenance non-intrusive way of purifying air without installing separate purification units
- Generates negative ions and emits through AC airflow, binding to pollutants sending them to the floor
- Plug & play: convert your ducted IDU into an air-purifying IDU
- More than 99.9% effective on SARS-CoV-2 virus
- Up to 96.85% capturing of Influenza virus
- Up to 74.90% removal of odors (formaldehyde)
- Minimum impact on energy consumption & noise compared to external air purifier
- Electrical power consumption: max 3W

#### Optional accessory filter AQtiv-Ion Kit



#### BENEFITS

<p><b>-99.9%</b> (Inhibition rate)</p>	<p><b>-96.64%</b> (Inhibition rate)</p>	<p><b>-96.85%</b> (Removal rate)</p>	<p><b>-93.88%</b> (Inhibition rate)</p>	<p><b>-94.46%</b> (Removal rate)</p>	<p><b>-74.90%</b> (Removal rate)</p>	<p><b>-73.20%</b> (Removal rate)</p>
--------------------------------------------	---------------------------------------------	------------------------------------------	---------------------------------------------	------------------------------------------	------------------------------------------	------------------------------------------

# Air Source Cooling Only Type

## LINE UP

(HP Class/Cooling Capacity/Net Weight/Operating Sound SPL (Full-anechoic) dB(A) in cooling mode)

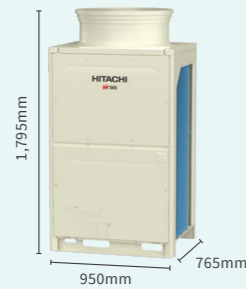

**Footprint 0.73m<sup>2</sup>**

8HP class/22.4kW/187kg/52.0dB(A)  
 10HP class/28.0kW/192kg/55.0dB(A)  
 12HP class/33.5kW/208kg/57.0dB(A)  
 14HP class/40.0kW/212kg/59.0dB(A)



**Footprint 0.93m<sup>2</sup>**

16HP class/45.0kW/253kg/61.0dB(A)  
 18HP class/50.4kW/259kg/61.0dB(A)  
 20HP class/56.0kW/259kg/61.0dB(A)



**Footprint 1.22m<sup>2</sup>**

22HP class/61.5kW/336kg/61.0dB(A)  
 24HP class/67.0kW/336kg/61.0dB(A)  
 26HP class/73.0kW/355kg/62.0dB(A)  
 28HP class/77.5kW/355kg/62.0dB(A)  
 30HP class/84.0kW/355kg/65.0dB(A)



**Footprint 3.40m<sup>2</sup>**

62HP class/173.4kW/931kg/66.0dB(A)  
 64HP class/178.9kW/931kg/66.0dB(A)  
 66HP class/184.4kW/931kg/66.0dB(A)



**Footprint 3.70m<sup>2</sup>**

68HP class/190.0kW/1,008kg/66.0dB(A) 80HP class/223.5kW/1,065kg/67.0dB(A)  
 70HP class/195.5kW/1,008kg/66.0dB(A) 82HP class/228.0kW/1,065kg/67.0dB(A)  
 72HP class/201.0kW/1,008kg/66.0dB(A) 84HP class/232.5kW/1,065kg/67.0dB(A)  
 74HP class/207.0kW/1,027kg/66.0dB(A) 86HP class/239.0kW/1,065kg/68.0dB(A)  
 76HP class/213.0kW/1,046kg/66.0dB(A) 88HP class/245.5kW/1,065kg/68.0dB(A)  
 78HP class/219.0kW/1,065kg/67.0dB(A) 90HP class/252.0kW/1,065kg/70.0dB(A)



**Footprint 1.67m<sup>2</sup>**

32HP class/90.4kW/471kg/63.0dB(A)



**Footprint 1.87m<sup>2</sup>**

34HP class/95.4kW/512kg/64.0dB(A)  
 36HP class/100.8kW/518kg/64.0dB(A)



**Footprint 4.94m<sup>2</sup>**

92HP class/257.0kW/1,344kg/67.0dB(A) 102HP class/286.0kW/1,401kg/68.0dB(A) 112HP class/310.0kW/1,420kg/68.0dB(A)  
 94HP class/262.5kW/1,344kg/67.0dB(A) 104HP class/292.0kW/1,420kg/68.0dB(A) 114HP class/316.5kW/1,420kg/69.0dB(A)  
 96HP class/268.0kW/1,344kg/67.0dB(A) 106HP class/296.5kW/1,420kg/68.0dB(A) 116HP class/323.0kW/1,420kg/70.0dB(A)  
 98HP class/274.0kW/1,363kg/67.0dB(A) 108HP class/301.0kW/1,420kg/68.0dB(A) 118HP class/329.5kW/1,420kg/70.0dB(A)  
 100HP class/280.0kW/1,382kg/68.0dB(A) 110HP class/305.5kW/1,420kg/68.0dB(A) 120HP class/336.0kW/1,420kg/71.0dB(A)



**Footprint 2.16m<sup>2</sup>**

38HP class/106.5kW/589kg/64.0dB(A)  
 40HP class/111.9kW/595kg/64.0dB(A)  
 42HP class/117.4kW/595kg/64.0dB(A)



**Footprint 2.46m<sup>2</sup>**

44HP class/123.0kW/672kg/64.0dB(A) 54HP class/150.5kW/710kg/65.0dB(A)  
 46HP class/128.5kW/672kg/64.0dB(A) 56HP class/155.0kW/710kg/65.0dB(A)  
 48HP class/134.0kW/672kg/64.0dB(A) 58HP class/162.3kW/710kg/67.0dB(A)  
 50HP class/140.0kW/691kg/64.5dB(A) 60HP class/167.8kW/710kg/68.0dB(A)  
 52HP class/146.0kW/710kg/65.0dB(A)

### Specification Notes

- (Note 1) The cooling and heating performances are the values when combined with our specified indoor units.  
 Cooling: 27°C DB/19°C WB indoor side, 35°C DB outdoor side  
 Piping Length: 7.5 Meters Piping Lift: 0 Meter
- (Note 2) The electric characteristics show values of single outdoor unit.
- (Note 3) The configuring outdoor unit cannot be combined other than shown in the table.
- (Note 4) The operating sound is based on the following conditions.  
 1 Meter from the unit service cover surface, and 1.5 Meters from floor level.  
 The above data was measured in an anechoic chamber so that reflected sound should be taken into consideration in the field.
- (Note 5) The dimensions show values when a space between outdoor units is 20 mm.
- (Note 6) In the case of setting low ambient temperature at cooling operation, the minimum capacity of connectable indoor unit should be 2.5HP.
- (Note 7) The total capacity of combined indoor units should be not over 150% against the outdoor unit capacity when 0.6HP indoor unit is combined.
- (Note 8) Refrigerant piping has some installation limitation in specific condition. Please refer to technical manual for details.
- (Note 9) When connection ratio of outdoor unit and indoor unit is over 130%, additional setting is required. Air volume of indoor unit is restricted under some of condition. Refer to technical manual for details.
- (Note 10) It is recommended to follow "Recommended IDU number" to avoid the cold draft during the heating operation. Please refer to technical manual for details.
- (Note 11) Some restrictions would be applied when the height difference between outdoor units and indoor units are 50m or more for outdoor unit is higher case, and 40m or more for outdoor units is lower case. Please refer to technical manual for details.

# Specifications

S



M



L



Capacity range		Unit	8HP	10HP	12HP	14HP	16HP	18HP	20HP	22HP	24HP	26HP	28HP
Outdoor unit model			RAS-080CNCLW	RAS-100CNCLW	RAS-120CNCLW	RAS-140CNCLW	RAS-160CNCLW	RAS-180CNCLW	RAS-200CNCLW	RAS-220CNCLW	RAS-240CNCLW	RAS-260CNCLW	RAS-280CNCLW
Combination of modules		-	-	-	-	-	-	-	-	-	-	-	-
Power supply		-	3N~ 380-415V 50Hz	3N~ 380-415V 50Hz	3N~ 380-415V 50Hz	3N~ 380-415V 50Hz	3N~ 380-415V 50Hz	3N~ 380-415V 50Hz	3N~ 380-415V 50Hz	3N~ 380-415V 50Hz	3N~ 380-415V 50Hz	3N~ 380-415V 50Hz	3N~ 380-415V 50Hz
Cooling capacity		kW	22.4	28.0	33.5	40.0	45.0	50.4	56.0	61.5	67.0	73.0	77.5
Outer dimensions (W x D x H)		mm	950×765×1,795	950×765×1,795	950×765×1,795	950×765×1,795	1,210×765×1,795	1,210×765×1,795	1,210×765×1,795	1,600×765×1,795	1,600×765×1,795	1,600×765×1,795	1,600×765×1,795
Packaging Measurement		m <sup>3</sup>	1.62	1.62	1.62	1.62	2.03	2.03	2.03	2.65	2.65	2.65	2.65
Weight	Net weight	kg	187	192	208	212	253	259	259	336	336	355	355
	Gross weight	kg	203	208	224	228	273	279	279	359	359	378	378
Noise	Cooling rating	SPL (Full-anechoic) dB(A)	52.0	55.0	57.0	59.0	61.0	61.0	61.0	61.0	61.0	62.0	62.0
	Night shift mode (noise reduction setting)	SPL (Full-anechoic) dB(A)	49.0	50.0	52.0	54.0	56.0	56.0	56.0	57.0	57.0	60.0	60.0
Electric characteristics	Power consumption	kW	4.15	5.82	7.20	9.64	10.49	12.29	13.83	14.04	16.38	19.47	20.95
	Operating current	A	8.3	10.4	12.6	16.3	19.2	21.7	24.1	25.7	29.6	33.6	36.2
	Breaker (A)	A	25	25	32	32	40	50	50	50	63	80	80
	MAX current	A	16.1	20.0	23.3	27.7	32.7	39.7	40.0	42.7	53.0	58.3	59.4
Energy efficiency	Cooling EER	-	5.40	4.81	4.65	4.15	4.29	4.10	4.05	4.38	4.09	3.75	3.70
Compressor	Compressor type	-	Hermetic(Scroll)	Hermetic(Scroll)	Hermetic(Scroll)	Hermetic(Scroll)	Hermetic(Scroll)	Hermetic(Scroll)	Hermetic(Scroll)	Hermetic(Scroll)	Hermetic(Scroll)	Hermetic(Scroll)	Hermetic(Scroll)
	Motor output	kW	3.50	5.04	6.14	8.30	9.28	10.90	12.33	6.23×2	7.28×2	8.64×2	9.33×2
Rated air volume		m <sup>3</sup> /min	175	175	198	207	256	263	263	329	348	375	375
Outdoor unit Fan	Number of Fan Motors	-	1	1	1	2	2	2	2	2	2	2	2
	Motor output	kW	0.26	0.26	0.43	0.51	0.35×2	0.38×2	0.38×2	0.4×2	0.47×2	0.58×2	0.58×2
Gas piping		mm	19.05	22.2	25.4	25.4	28.58	28.58	28.58	28.58	28.58	31.75	31.75
Main pipe size	Liquid piping	mm	9.52	9.52	12.7	12.7	12.7	15.88	15.88	15.88	15.88	19.05	19.05
	Tubing connection method	-	Welding connection	Welding connection	Welding connection	Welding connection	Welding connection	Welding connection	Welding connection	Welding connection	Welding connection	Welding connection	Welding connection
Operating temperature range		°C DB	-5°C (-10°C)~48<52>°C	-5°C (-10°C)~48<52>°C	-5°C (-10°C)~48<52>°C	-5°C (-10°C)~48<52>°C	-5°C (-10°C)~48<52>°C	-5°C (-10°C)~48<52>°C	-5°C (-10°C)~48<52>°C	-5°C (-10°C)~48<52>°C	-5°C (-10°C)~48<52>°C	-5°C (-10°C)~48<52>°C	-5°C (-10°C)~48<52>°C
Maximum External static pressure		Pa	80	80	80	80	80	80	80	80	80	80	80
Maximum Total piping length		m	1,000	1,000	1,000	1,000	1,000	1,000	1,000	1,000	1,000	1,000	1,000
Maximum piping length	Between ODU and IDU	Actual	m	200	200	200	200	200	200	200	200	200	200
		Equivalent	m	225	225	225	225	225	225	225	225	225	225
	Between "Piping connection kit" and each ODU single module	m	-	-	-	-	-	-	-	-	-	-	-
	Between "1st branch Multi Kit" and farthest IDU	m	100	100	100	100	100	100	100	100	100	100	100
Between "Multi Kit" and each connected IDU		m	40	40	40	40	40	40	40	40	40	40	40
Between each single module of 1 ODU		m	-	-	-	-	-	-	-	-	-	-	-
Maximum height difference	Between ODU and IDUs	ODU above IDU (*)	m	110 (50)	110 (50)	110 (50)	110 (50)	110 (50)	110 (50)	110 (50)	110 (50)	110 (50)	110 (50)
		IDU above ODU (*)	m	110 (40)	110 (40)	110 (40)	110 (40)	110 (40)	110 (40)	110 (40)	110 (40)	110 (40)	110 (40)
	Between IDUs	m	40	40	40	40	40	40	40	40	40	40	40
Refrigerant	Type	-	R410A	R410A	R410A	R410A	R410A	R410A	R410A	R410A	R410A	R410A	R410A
	Initial charge amount	kg	5.6	5.6	8.3	8.3	9.5	10.2	10.2	11.2	11.6	11.6	11.6
	Maximum additional charge amount	kg	28.0	28.0	36.0	36.0	40.0	40.0	40.0	46.0	46.0	56.0	56.0
	Refrigerant control mode	-	Microcomputer-controlled electronic expansion valve						Microcomputer-controlled electronic expansion valve				
Refrigerant oil	Type	-	FVC68D	FVC68D	FVC68D	FVC68D	FVC68D	FVC68D	FVC68D	FVC68D	FVC68D	FVC68D	FVC68D
	Charge amount	L	6.0	6.0	6.0	6.0	6.9	6.9	6.9	8.4	8.4	8.4	8.4
Connected capacity ratio		%	50~200%	50~200%	50~200%	50~200%	50~200%	50~200%	50~200%	50~200%	50~200%	50~200%	50~200%
With Indoor Unit	Maximum Number of connectable units (recommended number of units)	-	20 (8)	25 (10)	30 (10)	36 (16)	40 (16)	45 (16)	50 (18)	55 (20)	60 (26)	64 (26)	64 (32)
	Connectable minimum capacity	-	0.6HP class	0.6HP class	0.6HP class	0.6HP class	0.6HP class	0.6HP class	0.6HP class	0.6HP class	0.6HP class	0.6HP class	0.6HP class

# Specifications

L



MS



MM



LM



LL



Capacity range	Unit	30HP	32HP	34HP	36HP	38HP	40HP	42HP	44HP	46HP	48HP	50HP	
Outdoor unit model		RAS-300CNCLW	RAS-320CNCLW	RAS-340CNCLW	RAS-360CNCLW	RAS-380CNCLW	RAS-400CNCLW	RAS-420CNCLW	RAS-440CNCLW	RAS-460CNCLW	RAS-480CNCLW	RAS-500CNCLW	
Combination of modules	-	-	RAS-180CNCLW RAS-140CNCLW	RAS-180CNCLW RAS-160CNCLW	RAS-180CNCLW RAS-180CNCLW	RAS-220CNCLW RAS-160CNCLW	RAS-220CNCLW RAS-180CNCLW	RAS-240CNCLW RAS-180CNCLW	RAS-220CNCLW RAS-220CNCLW	RAS-240CNCLW RAS-220CNCLW	RAS-240CNCLW RAS-240CNCLW	RAS-260CNCLW RAS-240CNCLW	
Power supply	-	3N~ 380-415V 50Hz	3N~ 380-415V 50Hz	3N~ 380-415V 50Hz	3N~ 380-415V 50Hz	3N~ 380-415V 50Hz	3N~ 380-415V 50Hz	3N~ 380-415V 50Hz	3N~ 380-415V 50Hz	3N~ 380-415V 50Hz	3N~ 380-415V 50Hz	3N~ 380-415V 50Hz	
Cooling capacity	kW	84.0	90.4	95.4	100.8	106.5	111.9	117.4	123.0	128.5	134.0	140.0	
Outer dimensions (W x D x H)	mm	1,600×765×1,795	2,180×765×1,795	2,440×765×1,795	2,440×765×1,795	2,830×765×1,795	2,830×765×1,795	2,830×765×1,795	3,220×765×1,795	3,220×765×1,795	3,220×765×1,795	3,220×765×1,795	
Packaging Measurement	m <sup>3</sup>	3.65	2.03+1.62	2.03+2.03	2.03+2.03	2.65+2.03	2.65+2.03	2.65+2.03	2.65+2.65	2.65+2.65	2.65+2.65	2.65+2.65	
Weight	Net weight	kg	355	212+259	253+259	259+259	253+336	259+336	259+336	336+336	336+336	336+355	
	Gross weight	kg	378	228+279	273+279	279+279	273+359	279+359	279+359	359+359	359+359	359+378	
Noise	Cooling rating	SPL (Full-anechoic) dB(A)	65.0	63.0	64.0	64.0	64.0	64.0	64.0	64.0	64.0	65.0	
	Night shift mode (noise reduction setting)	SPL (Full-anechoic) dB(A)	60.0	58.0	59.0	59.0	60.0	60.0	60.0	60.0	60.0	62.0	
Electric characteristics	Power consumption	kW	25.69	21.93	22.78	24.59	24.53	26.33	28.67	28.08	30.42	32.76	35.85
	Operating current	A	42.9	38.0	40.9	43.4	44.9	47.4	51.3	51.4	55.3	59.2	63.2
	Breaker (A)	A	80	50+32	50+40	50+50	50+40	50+50	63+50	50+50	63+50	63+63	80+63
	MAX current	A	65.6	67.4	72.4	79.4	75.4	82.4	92.7	85.4	95.7	106.0	111.3
Energy efficiency	Cooling EER	-	3.27	4.12	4.19	4.10	4.34	4.25	4.09	4.38	4.22	4.09	3.91
Compressor	Compressor type	-	Hermetic(Scroll)	Hermetic(Scroll)	Hermetic(Scroll)	Hermetic(Scroll)	Hermetic(Scroll)	Hermetic(Scroll)	Hermetic(Scroll)	Hermetic(Scroll)	Hermetic(Scroll)	Hermetic(Scroll)	
	Motor output	kW	11.46×2	10.9+8.3	10.9+9.28	(10.9)×2	6.23×2+9.28	6.23×2+10.9	7.28×2+10.9	(6.23×2)×2	7.28×2+6.23×2	(7.28×2)×2	8.64×2+7.28×2
Outdoor unit Fan	Rated air volume	m <sup>3</sup> /min	405	207+263	256+263	263+263	256+329	263+329	263+348	329+329	329+348	348+348	348+375
	Number of Fan Motors	-	2+1	2+2	2+2	2+2	2+2	2+2	2+2	2+2	2+2	2+2	
Main pipe size	Motor output	kW	0.71×2	0.38×2+0.51	0.38×2+0.35×2	(0.38×2)×2	0.4×2+0.35×2	0.4×2+0.38×2	0.47×2+0.38×2	(0.4×2)×2	0.47×2+0.4×2	(0.47×2)×2	0.58×2+0.47×2
	Gas piping	mm	31.75	31.75	31.75	38.1	38.1	38.1	38.1	38.1	38.1	38.1	
	Liquid piping	mm	19.05	19.05	19.05	19.05	19.05	19.05	19.05	19.05	19.05	19.05	
	Tubing connection method	-	Welding connection	Welding connection	Welding connection	Welding connection	Welding connection	Welding connection	Welding connection	Welding connection	Welding connection	Welding connection	
Operating temperature range	°C DB	-5°C (-10°C)~48<52>°C	-5°C (-10°C)~48<52>°C	-5°C (-10°C)~48<52>°C	-5°C (-10°C)~48<52>°C	-5°C (-10°C)~48<52>°C	-5°C (-10°C)~48<52>°C	-5°C (-10°C)~48<52>°C	-5°C (-10°C)~48<52>°C	-5°C (-10°C)~48<52>°C	-5°C (-10°C)~48<52>°C	-5°C (-10°C)~48<52>°C	
Maximum External static pressure	Pa	80	80	80	80	80	80	80	80	80	80	80	
Maximum Total piping length	m	1,000	1,000	1,000	1,000	1,000	1,000	1,000	1,000	1,000	1,000	1,000	
Maximum piping length	Between ODU and IDU	Actual	m	200	200	200	200	200	200	200	200	200	
		Equivalent	m	225	225	225	225	225	225	225	225	225	
	Between "Piping connection kit" and each ODU single module	m	25	25	25	25	25	25	25	25	25	25	
	Between "1st branch Multi Kit" and farthest IDU	m	100	100	100	100	100	100	100	100	100	100	
	Between "Multi Kit" and each connected IDU	m	40	40	40	40	40	40	40	40	40	40	
Maximum height difference	Between each single module of 1 ODU	m	2	2	2	2	2	2	2	2	2	2	
	Between ODU and IDUs	ODU above IDU (*)	m	110 (50)	110 (50)	110 (50)	110 (50)	110 (50)	110 (50)	110 (50)	110 (50)	110 (50)	
		IDU above ODU (*)	m	110 (40)	110 (40)	110 (40)	110 (40)	110 (40)	110 (40)	110 (40)	110 (40)	110 (40)	
	Between IDUs	m	40	40	40	40	40	40	40	40	40	40	
Refrigerant	Type	-	R410A	R410A	R410A	R410A	R410A	R410A	R410A	R410A	R410A	R410A	
	Initial charge amount	kg	11.6	18.5	19.7	20.4	20.7	21.4	21.8	22.4	22.8	23.2	23.2
	Maximum additional charge amount	kg	56.0	76.0	80.0	80.0	86.0	86.0	86.0	92.0	92.0	102.0	
	Refrigerant control mode	-	Microcomputer-controlled electronic expansion valve					Microcomputer-controlled electronic expansion valve					
Refrigerant oil	Type	-	FVC68D	FVC68D	FVC68D	FVC68D	FVC68D	FVC68D	FVC68D	FVC68D	FVC68D	FVC68D	
	Charge amount	L	8.4	12.9	13.8	13.8	15.3	15.3	15.3	16.8	16.8	16.8	16.8
With Indoor Unit	Connected capacity ratio	%	50~200%	50~200%	50~200%	50~200%	50~200%	50~200%	50~200%	50~200%	50~200%	50~200%	
	Maximum Number of connectable units (recommended number of units)	-	64 (32)	64 (32)	64 (32)	64 (32)	64 (38)	64 (38)	64 (38)	64 (38)	64 (38)	64 (38)	
	Connectable minimum capacity	-	0.6HP class	0.6HP class	0.6HP class	0.6HP class	0.6HP class	0.6HP class	0.6HP class	0.6HP class	0.6HP class	0.6HP class	

# Specifications

LL



LMM



LLL



Capacity range	Unit	52HP	54HP	56HP	58HP	60HP	62HP	64HP	66HP	68HP	70HP	72HP	
Outdoor unit model		RAS-520CNCLW	RAS-540CNCLW	RAS-560CNCLW	RAS-580CNCLW	RAS-600CNCLW	RAS-620CNCLW	RAS-640CNCLW	RAS-660CNCLW	RAS-680CNCLW	RAS-700CNCLW	RAS-720CNCLW	
Combination of modules		RAS-260CNCLW RAS-260CNCLW	RAS-280CNCLW RAS-260CNCLW	RAS-280CNCLW RAS-280CNCLW	RAS-300CNCLW RAS-280CNCLW	RAS-300CNCLW RAS-300CNCLW	RAS-220CNCLW RAS-220CNCLW RAS-180CNCLW	RAS-240CNCLW RAS-220CNCLW RAS-180CNCLW	RAS-240CNCLW RAS-240CNCLW RAS-180CNCLW	RAS-240CNCLW RAS-220CNCLW RAS-220CNCLW	RAS-240CNCLW RAS-240CNCLW RAS-220CNCLW	RAS-240CNCLW RAS-240CNCLW RAS-240CNCLW	
Power supply	-	3N~ 380-415V 50Hz	3N~ 380-415V 50Hz	3N~ 380-415V 50Hz	3N~ 380-415V 50Hz	3N~ 380-415V 50Hz	3N~ 380-415V 50Hz	3N~ 380-415V 50Hz	3N~ 380-415V 50Hz	3N~ 380-415V 50Hz	3N~ 380-415V 50Hz	3N~ 380-415V 50Hz	
Cooling capacity	kW	146.0	150.5	155.0	161.5	168.0	173.4	178.9	184.4	190.0	195.5	201.0	
Outer dimensions (W x D x H)	mm	3,220×765×1,795	3,220×765×1,795	3,220×765×1,795	3,220×765×1,795	3,220×765×1,795	4,450×765×1,795	4,450×765×1,795	4,450×765×1,795	4,840×765×1,795	4,840×765×1,795	4,840×765×1,795	
Packaging Measurement	m <sup>3</sup>	2.65+2.65	2.65+2.65	2.65+2.65	2.65+2.65	2.65+2.65	2.65+2.65+2.03	2.65+2.65+2.03	2.65+2.65+2.03	2.65+2.65+2.65	2.65+2.65+2.65	2.65+2.65+2.65	
Weight	Net weight	kg	355+355	355+355	355+355	355+355	355+355	259+336+336	259+336+336	259+336+336	336+336+336	336+336+336	
	Gross weight	kg	378+378	378+378	378+378	378+378	378+378	279+359+359	279+359+359	279+359+359	359+359+359	359+359+359	
Noise	Cooling rating	SPL (Full-anechoic) dB(A)	65.0	65.0	65.0	67.0	68.0	66.0	66.0	66.0	66.0	66.0	
	Night shift mode (noise reduction setting)	SPL (Full-anechoic) dB(A)	63.0	63.0	63.0	63.0	63.0	61.0	61.0	61.0	62.0	62.0	
Electric characteristics	Power consumption	kW	38.93	40.41	41.89	46.63	51.38	40.37	42.72	45.06	44.46	46.80	
	Operating current	A	67.2	69.8	72.4	79.1	85.8	73.1	77.0	80.9	81.0	84.9	
	Breaker (A)	A	80+80	80+80	80+80	80+80	80+80	50+50+50	63+50+50	63+63+50	63+50+50	63+63+50	
	MAX current	A	116.6	117.7	118.8	125.0	131.2	125.1	135.4	145.7	138.4	148.7	
Energy efficiency	Cooling EER	-	3.75	3.72	3.70	3.46	3.27	4.30	4.19	4.09	4.27	4.18	
Compressor	Compressor type	-	Hermetic(Scroll)	Hermetic(Scroll)	Hermetic(Scroll)	Hermetic(Scroll)	Hermetic(Scroll)	Hermetic(Scroll)	Hermetic(Scroll)	Hermetic(Scroll)	Hermetic(Scroll)	Hermetic(Scroll)	
	Motor output	kW	(8.64×2)×2	9.33×2+8.64×2	(9.33×2)×2	11.46×2+9.33×2	(11.46×2)×2	(6.23×2)×2+10.9	7.28×2+6.23×2+10.9	(7.28×2)×2+10.9	7.28×2+(6.23×2)×2	(7.28×2)×2+6.23×2	(7.28×2)×3
Outdoor unit Fan	Rated air volume	m <sup>3</sup> /min	375+375	375+375	375+375	375+405	405+405	263+329+329	263+329+348	263+348+348	329+329+348	329+348+348	
	Number of Fan Motors	-	2+2	2+2	2+2	2+2+2	2+2+2	2+2+2	2+2+2	2+2+2	2+2+2	2+2+2	
	Motor output	kW	(0.58×2)×2	0.58×2+0.58×2	(0.58×2)×2	0.71×2+0.58×2	(0.71×2)×2	(0.4×2)×2+0.38×2	0.47×2+0.4×2+0.38×2	(0.47×2)×2+0.38×2	0.47×2+(0.4×2)×2	(0.47×2)×2+0.4×2	(0.47×2)×3
Main pipe size	Gas piping	mm	38.1	38.1	44.45	44.45	44.45	44.45	44.45	44.45	44.45	44.45	
	Liquid piping	mm	19.05	19.05	19.05	19.05	19.05	19.05	19.05	22.2	22.2	22.2	
	Tubing connection method	-	Welding connection	Welding connection	Welding connection	Welding connection	Welding connection	Welding connection	Welding connection	Welding connection	Welding connection	Welding connection	
Operating temperature range	°C DB	-5°C (-10°C)~48<52>°C	-5°C (-10°C)~48<52>°C	-5°C (-10°C)~48<52>°C	-5°C (-10°C)~48<52>°C	-5°C (-10°C)~48<52>°C	-5°C (-10°C)~48<52>°C	-5°C (-10°C)~48<52>°C	-5°C (-10°C)~48<52>°C	-5°C (-10°C)~48<52>°C	-5°C (-10°C)~48<52>°C	-5°C (-10°C)~48<52>°C	
Maximum External static pressure	Pa	80	80	80	80	80	80	80	80	80	80	80	
Maximum Total piping length	m	1,000	1,000	1,000	1,000	1,000	1,000	1,000	1,000	1,000	1,000	1,000	
Maximum piping length	Between ODU and IDU	Actual	m	200	200	200	200	200	200	200	200	200	
		Equivalent	m	225	225	225	225	225	225	225	225	225	
	Between "Piping connection kit" and each ODU single module	m	25	25	25	25	25	25	25	25	25	25	
	Between "1st branch Multi Kit" and farthest IDU	m	100	100	100	100	100	100	100	100	100	100	
Between "Multi Kit" and each connected IDU	m	40	40	40	40	40	40	40	40	40	40		
Maximum height difference	Between each single module of 1 ODU	m	2	2	2	2	2	2	2	2	2	2	
	Between ODU and IDUs	ODU above IDU (*)	m	110 (50)	110 (50)	110 (50)	110 (50)	110 (50)	110 (50)	110 (50)	110 (50)	110 (50)	110 (50)
		IDU above ODU (*)	m	110 (40)	110 (40)	110 (40)	110 (40)	110 (40)	110 (40)	110 (40)	110 (40)	110 (40)	110 (40)
	Between IDUs	m	40	40	40	40	40	40	40	40	40	40	
Refrigerant	Type	-	R410A	R410A	R410A	R410A	R410A	R410A	R410A	R410A	R410A	R410A	
	Initial charge amount	kg	23.2	23.2	23.2	23.2	23.2	32.6	33.0	33.4	34.0	34.8	
	Maximum additional charge amount	kg	112.0	112.0	112.0	112.0	112.0	132.0	132.0	132.0	138.0	138.0	
	Refrigerant control mode	-	Microcomputer-controlled electronic expansion valve					Microcomputer-controlled electronic expansion valve					
Refrigerant oil	Type	-	FVC68D	FVC68D	FVC68D	FVC68D	FVC68D	FVC68D	FVC68D	FVC68D	FVC68D	FVC68D	
	Charge amount	L	16.8	16.8	16.8	16.8	16.8	23.7	23.7	23.7	25.2	25.2	
With Indoor Unit	Connected capacity ratio	%	50~200%	50~200%	50~180%	50~150%	50~150%	50~150%	50~150%	50~150%	50~150%	50~150%	
	Maximum Number of connectable units (recommended number of units)	-	64 (38)	64 (38)	64 (38)	64 (38)	64 (38)	64 (38)	64 (38)	64 (38)	64 (38)	64 (38)	
	Connectable minimum capacity	-	0.6HP class	0.6HP class	0.6HP class	0.6HP class	0.6HP class	0.6HP class	0.6HP class	0.6HP class	0.6HP class	0.6HP class	

# Specifications

LLL



LLLL



Capacity range	Unit	74HP	76HP	78HP	80HP	82HP	84HP	86HP	88HP	90HP	92HP	94HP	
Outdoor unit model		RAS-740CNCLW	RAS-760CNCLW	RAS-780CNCLW	RAS-800CNCLW	RAS-820CNCLW	RAS-840CNCLW	RAS-860CNCLW	RAS-880CNCLW	RAS-900CNCLW	RAS-920CNCLW	RAS-940CNCLW	
Combination of modules		RAS-260CNCLW RAS-240CNCLW RAS-240CNCLW	RAS-260CNCLW RAS-260CNCLW RAS-240CNCLW	RAS-260CNCLW RAS-260CNCLW RAS-260CNCLW	RAS-280CNCLW RAS-260CNCLW RAS-260CNCLW	RAS-280CNCLW RAS-280CNCLW RAS-260CNCLW	RAS-280CNCLW RAS-280CNCLW RAS-280CNCLW	RAS-300CNCLW RAS-280CNCLW RAS-280CNCLW	RAS-300CNCLW RAS-300CNCLW RAS-280CNCLW	RAS-300CNCLW RAS-300CNCLW RAS-300CNCLW	RAS-240CNCLW RAS-240CNCLW RAS-220CNCLW RAS-220CNCLW	RAS-240CNCLW RAS-240CNCLW RAS-240CNCLW RAS-220CNCLW	
Power supply	-	3N~ 380-415V 50Hz	3N~ 380-415V 50Hz	3N~ 380-415V 50Hz	3N~ 380-415V 50Hz	3N~ 380-415V 50Hz	3N~ 380-415V 50Hz	3N~ 380-415V 50Hz	3N~ 380-415V 50Hz	3N~ 380-415V 50Hz	3N~ 380-415V 50Hz	3N~ 380-415V 50Hz	
Cooling capacity	kW	207.0	213.0	219.0	223.5	228.0	232.5	239.0	245.5	252.0	257.0	262.5	
Outer dimensions (W x D x H)	mm	4,840×765×1,795	4,840×765×1,795	4,840×765×1,795	4,840×765×1,795	4,840×765×1,795	4,840×765×1,795	4,840×765×1,795	4,840×765×1,795	4,840×765×1,795	6,460×765×1,795	6,460×765×1,795	
Packaging Measurement	m <sup>3</sup>	2.65+2.65+2.65	2.65+2.65+2.65	2.65+2.65+2.65	2.65+2.65+2.65	2.65+2.65+2.65	2.65+2.65+2.65	2.65+2.65+2.65	2.65+2.65+2.65	2.65+2.65+2.65	2.65+2.65+2.65+2.65	2.65+2.65+2.65+2.65	
Weight	Net weight	kg	336+336+355	336+355+355	355+355+355	355+355+355	355+355+355	355+355+355	355+355+355	355+355+355	336+336+336+336	336+336+336+336	
	Gross weight	kg	359+359+378	359+378+378	378+378+378	378+378+378	378+378+378	378+378+378	378+378+378	378+378+378	378+378+378	359+359+359+359	359+359+359+359
Noise	Cooling rating	SPL (Full-anechoic) dB(A)	66.0	66.0	67.0	67.0	67.0	67.0	68.0	69.0	70.0	67.0	
	Night shift mode (noise reduction setting)	SPL (Full-anechoic) dB(A)	63.0	64.0	65.0	65.0	65.0	65.0	65.0	65.0	65.0	63.0	
Electric characteristics	Power consumption	kW	52.23	55.31	58.40	59.88	61.36	62.84	67.58	72.32	77.06	60.85	
	Operating current	A	92.8	96.8	100.8	103.4	106.0	108.6	115.3	122.0	128.7	110.6	
	Breaker (A)	A	80+63+63	80+80+63	80+80+80	80+80+80	80+80+80	80+80+80	80+80+80	80+80+80	80+80+80	63+63+50+50	63+63+63+50
	MAX current	A	164.3	169.6	174.9	176.0	177.1	178.2	184.4	190.6	196.8	191.4	201.7
Energy efficiency	Cooling EER	-	3.96	3.85	3.75	3.73	3.72	3.70	3.54	3.39	3.27	4.22	
Compressor	Compressor type	-	Hermetic(Scroll)	Hermetic(Scroll)	Hermetic(Scroll)	Hermetic(Scroll)	Hermetic(Scroll)	Hermetic(Scroll)	Hermetic(Scroll)	Hermetic(Scroll)	Hermetic(Scroll)	Hermetic(Scroll)	
	Motor output	kW	8.64×2+(7.28×2)×2	(8.64×2)×2+7.28×2	(8.64×2)×3	9.33×2+(8.64×2)×2	(9.33×2)×2+8.64×2	(9.33×2)×3	11.46×2+(9.33×2)×2	(11.46×2)×2+9.33×2	(11.46×2)×3	(7.28×2)×2+(6.23×2)×2	(7.28×2)×3+6.23×2
	Rated air volume	m <sup>3</sup> /min	348+348+375	348+375+375	375+375+375	375+375+375	375+375+375	375+375+375	375+375+405	375+405+405	405+405+405	329+329+348+348	329+348+348+348
Outdoor unit Fan	Number of Fan Motors	-	2+2+2	2+2+2	2+2+2	2+2+2	2+2+2	2+2+2	2+2+2	2+2+2	2+2+2	2+2+2	
	Motor output	kW	0.58×2+(0.47×2)×2	(0.58×2)×2+0.47×2	(0.58×2)×3	0.58×2+(0.58×2)×2	(0.58×2)×2+0.58×2	(0.58×2)×3	0.71×2+(0.58×2)×2	(0.71×2)×2+0.58×2	(0.71×2)×3	(0.47×2)×2+(0.4×2)×2	(0.47×2)×3+0.4×2
Main pipe size	Gas piping	mm	50.8	50.8	50.8	50.8	50.8	50.8	50.8	50.8	50.8	50.8	
	Liquid piping	mm	22.2	22.2	22.2	22.2	22.2	22.2	22.2	25.4	25.4	25.4	
	Tubing connection method	-	Welding connection	Welding connection	Welding connection	Welding connection	Welding connection	Welding connection	Welding connection	Welding connection	Welding connection	Welding connection	
Operating temperature range	°C DB	-5°C (-10°C)~48<52>°C	-5°C (-10°C)~48<52>°C	-5°C (-10°C)~48<52>°C	-5°C (-10°C)~48<52>°C	-5°C (-10°C)~48<52>°C	-5°C (-10°C)~48<52>°C	-5°C (-10°C)~48<52>°C	-5°C (-10°C)~48<52>°C	-5°C (-10°C)~48<52>°C	-5°C (-10°C)~48<52>°C	-5°C (-10°C)~48<52>°C	
Maximum External static pressure	Pa	80	80	80	80	80	80	80	80	80	80	80	
Maximum Total piping length	m	1,000	1,000	1,000	1,000	1,000	1,000	1,000	1,000	1,000	1,000	1,000	
Maximum piping length	Between ODU and IDU	Actual	m	200	200	200	200	200	200	200	200	200	
		Equivalent	m	225	225	225	225	225	225	225	225	225	
	Between "Piping connection kit" and each ODU single module	m	25	25	25	25	25	25	25	25	25	25	
	Between "1st branch Multi Kit" and farthest IDU	m	100	100	100	100	100	100	100	100	100	100	
	Between "Multi Kit" and each connected IDU	m	40	40	40	40	40	40	40	40	40	40	
Maximum height difference	Between each single module of 1 ODU	m	2	2	2	2	2	2	2	2	2	2	
	Between ODU and IDUs	ODU above IDU (*)	m	110 (50)	110 (50)	110 (50)	110 (50)	110 (50)	110 (50)	110 (50)	110 (50)	110 (50)	110 (50)
		IDU above ODU (*)	m	110 (40)	110 (40)	110 (40)	110 (40)	110 (40)	110 (40)	110 (40)	110 (40)	110 (40)	110 (40)
	Between IDUs	m	40	40	40	40	40	40	40	40	40	40	
Refrigerant	Type	-	R410A	R410A	R410A	R410A	R410A	R410A	R410A	R410A	R410A	R410A	
	Initial charge amount	kg	34.8	34.8	34.8	34.8	34.8	34.8	34.8	34.8	45.6	46.0	
	Maximum additional charge amount	kg	148.0	158.0	168.0	168.0	168.0	168.0	168.0	168.0	184.0	184.0	
	Refrigerant control mode	-	Microcomputer-controlled electronic expansion valve					Microcomputer-controlled electronic expansion valve					
Refrigerant oil	Type	-	FVC68D	FVC68D	FVC68D	FVC68D	FVC68D	FVC68D	FVC68D	FVC68D	FVC68D	FVC68D	
	Charge amount	L	25.2	25.2	25.2	25.2	25.2	25.2	25.2	25.2	33.6	33.6	
With Indoor Unit	Connected capacity ratio	%	50~150%	50~150%	50~150%	50~150%	50~150%	50~150%	50~150%	50~150%	50~150%	50~150%	
	Maximum Number of connectable units (recommended number of units)	-	64 (38)	64 (38)	64 (38)	64 (38)	64 (38)	64 (38)	64 (38)	64 (38)	64 (38)	64 (38)	
	Connectable minimum capacity	-	0.6HP class	0.6HP class	0.6HP class	0.6HP class	0.6HP class	0.6HP class	0.6HP class	0.6HP class	0.6HP class	0.6HP class	





# Specifications

LLLL



Capacity range		Unit	118HP	120HP	
<b>Outdoor unit model</b>			<b>RAS-H18CNCCLW</b>	<b>RAS-H20CNCCLW</b>	
Combination of modules			RAS-300CNCCLW RAS-300CNCCLW RAS-300CNCCLW RAS-280CNCCLW	RAS-300CNCCLW RAS-300CNCCLW RAS-300CNCCLW RAS-300CNCCLW	
Power supply		-	3N~ 380-415V 50Hz	3N~ 380-415V 50Hz	
Cooling capacity		kW	329.5	336.0	
Outer dimensions (W x D x H)		mm	6,460×765×1,795	6,460×765×1,795	
Packaging Measurement		m <sup>3</sup>	2.65+2.65+2.65+2.65	2.65+2.65+2.65+2.65	
Weight	Net weight	kg	355+355+355+355	355+355+355+355	
	Gross weight	kg	378+378+378+378	378+378+378+378	
Noise	Cooling rating	SPL (Full-anechoic) dB(A)	70.0	71.0	
	Night shift mode (noise reduction setting)	SPL (Full-anechoic) dB(A)	66.0	66.0	
Electric characteristics	Power consumption	kW	98.01	102.75	
	Operating current	A	164.9	171.6	
	Breaker (A)	A	80+80+80+80	80+80+80+80	
	MAX current	A	256.2	262.4	
Energy efficiency		Cooling EER	- 3.36	- 3.27	
Compressor	Compressor type	-	Hermetic(Scroll)	Hermetic(Scroll)	
	Motor output	kW	(11.46×2)×3+9.33×2	(11.46×2)×4	
	Rated air volume	m <sup>3</sup> /min	375+405+405+405	405+405+405+405	
Outdoor unit Fan	Number of Fan Motors	-	2+2+2+2	2+2+2+2	
	Motor output	kW	(0.71×2)×3+0.58×2	(0.71×2)×4	
Main pipe size	Gas piping	mm	54.0	54.0	
	Liquid piping	mm	28.58	28.58	
	Tubing connection method	-	Welding connection	Welding connection	
Operating temperature range		°C DB	-5°C (-10°C)~48<52>°C	-5°C (-10°C)~48<52>°C	
Maximum External static pressure		Pa	80	80	
Maximum Total piping length		m	1,000	1,000	
Maximum piping length	Between ODU and IDU	Actual	m	200	200
		Equivalent	m	225	225
	Between "Piping connection kit" and each ODU single module	m	25	25	
	Between "1st branch Multi Kit" and farthest IDU	m	100	100	
	Between "Multi Kit" and each connected IDU	m	40	40	
Maximum height difference	Between each single module of 1 ODU		m	2	2
	Between ODU and IDUs	ODU above IDU (*)	m	110 (50)	110 (50)
		IDU above ODU (*)	m	110 (40)	110 (40)
Between IDUs		m	40	40	
Refrigerant	Type	-	R410A	R410A	
	Initial charge amount	kg	46.4	46.4	
	Maximum additional charge amount	kg	224.0	224.0	
	Refrigerant control mode	-	Microcomputer-controlled electronic expansion valve		
Refrigerant oil	Type	-	FVC68D	FVC68D	
	Charge amount	L	33.6	33.6	
With Indoor Unit	Connected capacity ratio	%	50~150%	50~150%	
	Maximum Number of connectable units (recommended number of units)	-	64 (38)	64 (38)	
	Connectable minimum capacity	-	0.6HP class	0.6HP class	

# Option

## 1) Piping Connection Kit

\*For Cooling Only (2 Pipes)

Model name	Applicable Outdoor Unit		Remarks
	Combined X modules	air365 Max	
MC-NP21SA1	2	32 to 48 HP	for Gas : 1 for Liquid : 1
MC-NP22TA		50 to 60 HP	
MC-NP31TA	3	62 to 90 HP	for Gas : 2 for Liquid : 2
MC-NP40TA		92 to 120 HP	

## 2) Multi-Kit

\*For Cooling Only (2 Pipes)

Line branch

(First branch)

Model Name	Outdoor Unit HP
MW-NP282A3	8, 10
MW-NP452A3	12 to 16
MW-NP692A3	18 to 24
MW-NP902A3	26 to 54
MW-NP2682A3	56 to 120

(After First Branch)

Model Name	Total Indoor Unit HP
MW-NP282A3	< 12
MW-NP452A3	12 to 17.99
MW-NP692A3	18 to 25.99
MW-NP902A3	26 to 55.99
MW-NP2682A3	≥ 56

Header Branch

Model Name	Total Indoor Unit HP	No. of Header branches
MH-NP224A	8HP to less	4
MH-NP288A	10HP to less	8

# Accessories

## 1) Air Outlet Duct Kit



Air Outlet Duct Kit (Available upon order)	
S cabinet	FDK-TP20A
M cabinet	FDK-TP20B
L cabinet	FDK-TP20C

## 2) Protection Net



	Protection Net	
	Back	Right & LeftSide
S cabinet	PN-TP30BA	PN-TP30LR x 2
M cabinet	PN-TP30BB	PN-TP30LR x 2
L cabinet	PN-TP30BC	PN-TP30LR x 2

## 3) Air Inlet Grille



	Air Inlet Grille	
	Back	Right & LeftSide
S cabinet	PSN-TP30BA	PSN-TP30LR x 2
M cabinet	PSN-TP30BB	PSN-TP30LR x 2
L cabinet	PSN-TP30BC	PSN-TP30LR x 2



## Comfort first

For each space its own indoor unit. Our wide range of units can meet any type of requirement and space layout, and seamlessly integrate with interiors.

With seamless and quiet operation, your customers can relax and enjoy the air while using only the amount energy needed. Advanced functions such as GentleCool and AutoBoost allow you to customize the air in each space to suit your customers' preferences, while smart design minimizes the need for maintenance.

# INDOOR UNITS

52 Line-up summary

53 Our key indoor features

59 Indoor Air Quality

63 Solutions

63 Ducted units

66 High ESP [RPIH-HNAUN1Q, RPI-FSNQ] (AC) **NEW**

High ESP [RPIH-HNDUSQ] (DC) **NEW**

67 Medium ESP [RPIM-HNAUN1Q, RPI-FSN3Q] (AC) **NEW**

Low ESP [RPIL-HNAUN1Q] (AC) **NEW**

68 Compact [RPIZ-HNATN1Q] (AC) **NEW**

Compact [RPIZ-HNDTS1Q] (DC) **NEW**

69 Ceiling cassettes

71 Silent-Ionic™ (4-way cassette design panel)

73 4-way cassette [RCI-FSRP, RCI-FSKDN1Q] (DC) **NEW**

74 4-way compact cassette [RCIM-FSRE] (DC)

75 2-way cassette [RCD-FSR] (DC)

76 1-way cassette [RCS-FSR] (DC)

77 Other indoor units

79 Wall mounted [RPK-FSRM] (DC)

80 Wall mounted [RPK-HNBUSQ] (DC)

81 Floor/Ceiling convertible [RPFC-FSNQ] (AC)

82 Ceiling suspended [RPC-FSR] (DC)

83 Floor concealed [RPFI-FSNQ] (AC)

84 Specifications & accessories



# Line-up summary

Over 18 types available!

## DUCTED | The ultimate invisibility.

**NEW**  
**HIGH ESP (AC)**  
 RPIH-HNAUN1Q, RPI-FSNQ



**NEW**  
**HIGH ESP (DC)**  
 RPIH-HNDUSQ



**NEW**  
**MEDIUM ESP (AC)**  
 RPIH-HNAUN1Q, RPI-FSN3Q



**NEW**  
**LOW ESP (AC)**  
 RPIL-HNAUN1Q



**NEW**  
**COMPACT (AC)**  
 RPIZ-HNATN1Q

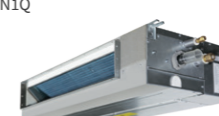

**NEW**  
**COMPACT (DC)**  
 RPIZ-HNDTS1Q

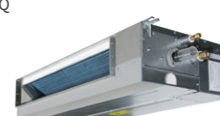

## CASSETTE | Consistent air reaching every corner of a room.

**4-WAY CASSETTE (DC)**  
 RCI-FSRP

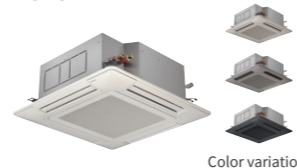

**NEW**  
**4-WAY CASSETTE (DC)**  
 RCI-FSKDN1Q



**TWIN-SENSE SYSTEM**  
 RCI-FSRP+ P-AP160NAE2  
 RCI-FSKDN1Q+ P-AP160NAE2+OPT-EZJ01



**Silent-Ionic™ Design Panel**  
 P-GP160NAP, P-GP160NAPU, P-GP160KAP

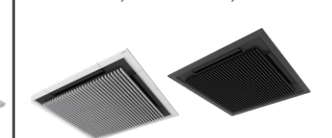

**4-WAY COMPACT CASSETTE (DC)**  
 RCIM-FSRE



**2-WAY CASSETTE (DC)**  
 RCD-FSR



**1-WAY CASSETTE (DC)**  
 RCS-FSR



## OTHERS | Minimal installation or retrofit works.

**WALL MOUNTED (DC)**  
 RPK-FSRM



**WALL MOUNTED (DC)**  
 RPK-HNBUSQ



**FLOOR/CEILING CONVERTIBLE (AC)**  
 RPF-CFSNQ



**CEILING SUSPENDED (DC)**  
 RPC-FSR



**FLOOR CONCEALED (AC)**  
 RPF1-FSNQ



# Our key indoor features

Hitachi air, making a difference.

EXCLUSIVE

## GENTLECOOL (FOR COOLING OPERATION)



Set not only your desired room temperature, but the cooled air temperature!

Without GentleCool, the unit might blow cooler air than expected when adjusting the indoor air temperature, causing a cool draft sensation at the beginning of operation.

With GentleCool, users have control over how discharged air reaches a preferred temperature setting, ensuring a smoother cooling down effect.

GentleCool might affect the speed of the room's cooling down to the set temperature.

### Potential discomfort.

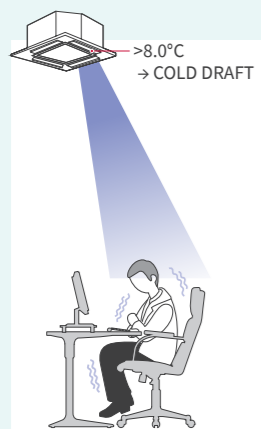

GentleCool  
OFF

### GentleCool : no cold draft.

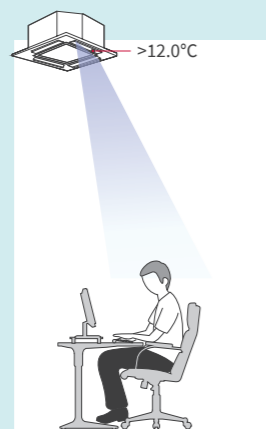

GentleCool  
LOW

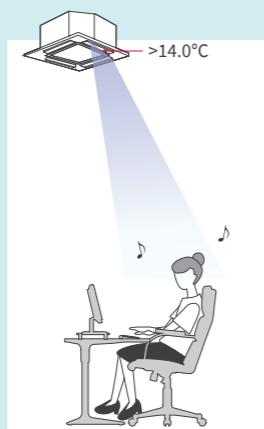

GentleCool  
MED

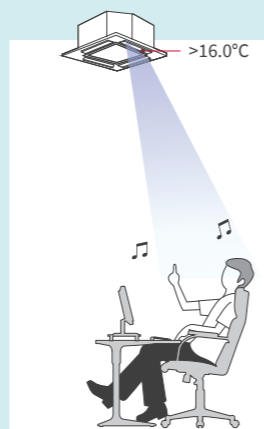

GentleCool  
HIGH

EXCLUSIVE

## CROWD-SENSE: PREDICTIVE ADJUSTMENT TO OCCUPANCY VARIATIONS

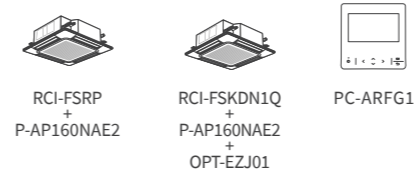

Ideal for meeting rooms, restaurants, museums and other venues experiencing rapid changes of occupancy.

With conventional air conditioning, the arrival of more occupants creates new sources of heat and may naturally disrupt indoor thermal comfort. With Crowd-Sense predictive control, enjoy a stable indoor temperature whenever the size of the crowd changes.

- Hitachi Twin-Sense cassette detects the crowd's arrival or departure.
- Using AI, the cassette can anticipate the addition or reduction of human heat sources and immediately adjusts the air conditioning accordingly.

### Crowd-Sense action during cooling.

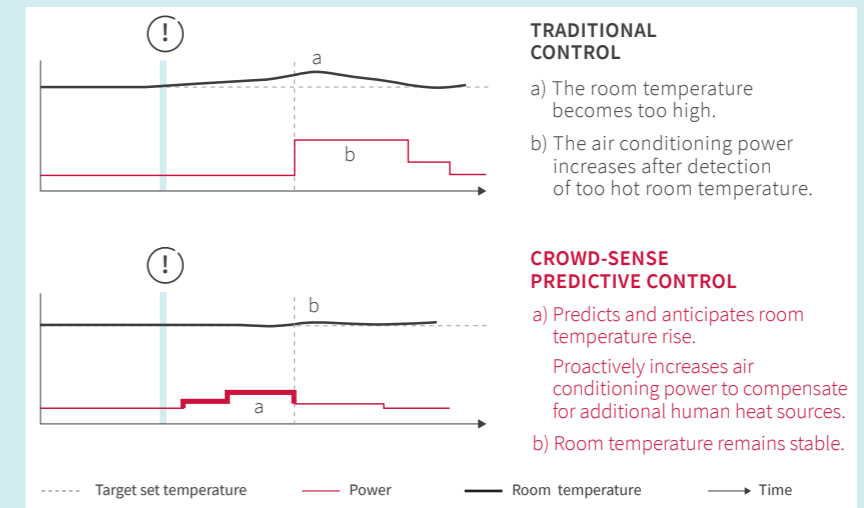
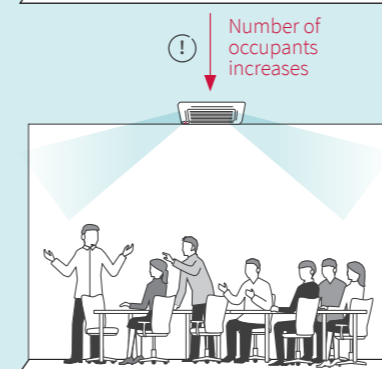
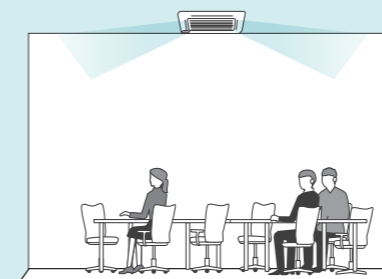

Crowd-Sense may not be effective or might be less effective in the following cases:

- Multiple indoor units are in operation in the same zone.
- The difference between the radiant temperature of the room (floor and walls) and the radiant temperature of the human body is minimal.
- The room temperature is high before operation.

# Our key indoor features

Hitachi air, making a difference.

## FLOORSENSE COOL (FOR COOLING OPERATION)

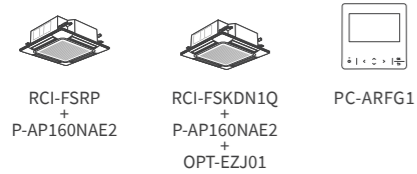

Prevents floor overcooling.

When the room has undergone prolonged cooling, the floor may overcool, due to cold air sinking below layers of warmer air. The radiant sensor can detect when the floor becomes too cold. The air conditioning automatically blows softer to prevent overcooling.\*<sup>1</sup>

\*<sup>1</sup> When a group of people return to the room or the room temperature rises due to sunlight, the cooling operation returns to normal.

## CHOICE OF DIRECT OR INDIRECT AIR FLOW

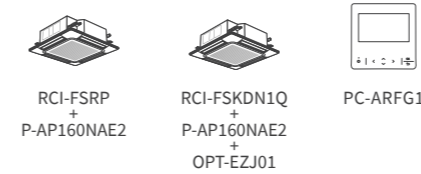

Want to feel the air? Or do you prefer imperceptible air?

Choose the preferred air sensation and let the air conditioner adjust the louver direction to your liking.

Our 4-zone motion sensor divides the room into 4 areas and can detect presence in each of them.

- Choose Direct air flow: the Twin-Sense cassette will target the corners with human activity.
- Choose Indirect air flow: Twin-Sense cassette will avoid the corners where occupants are detected.

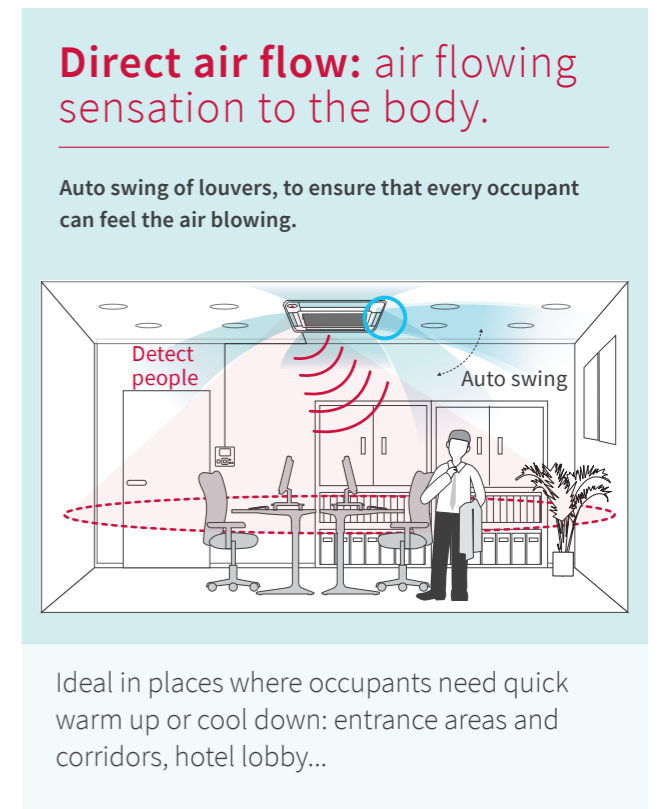
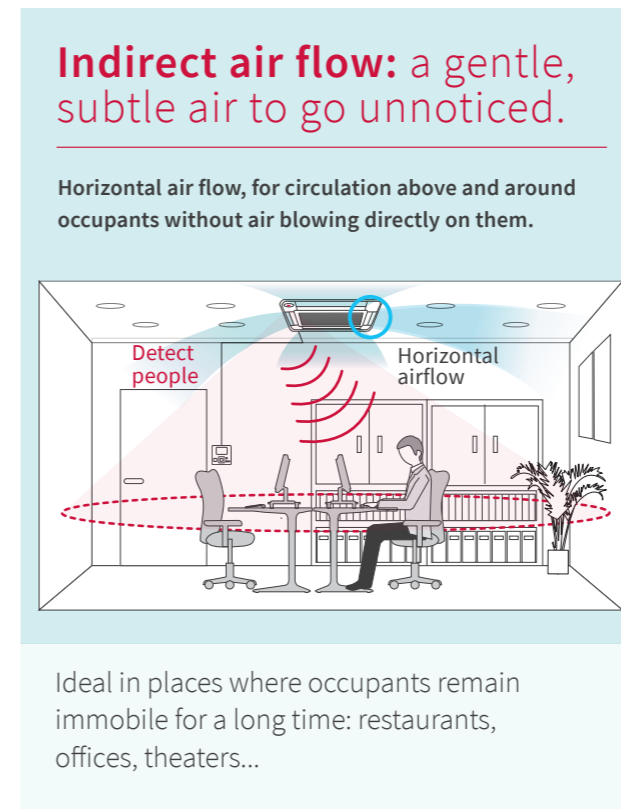
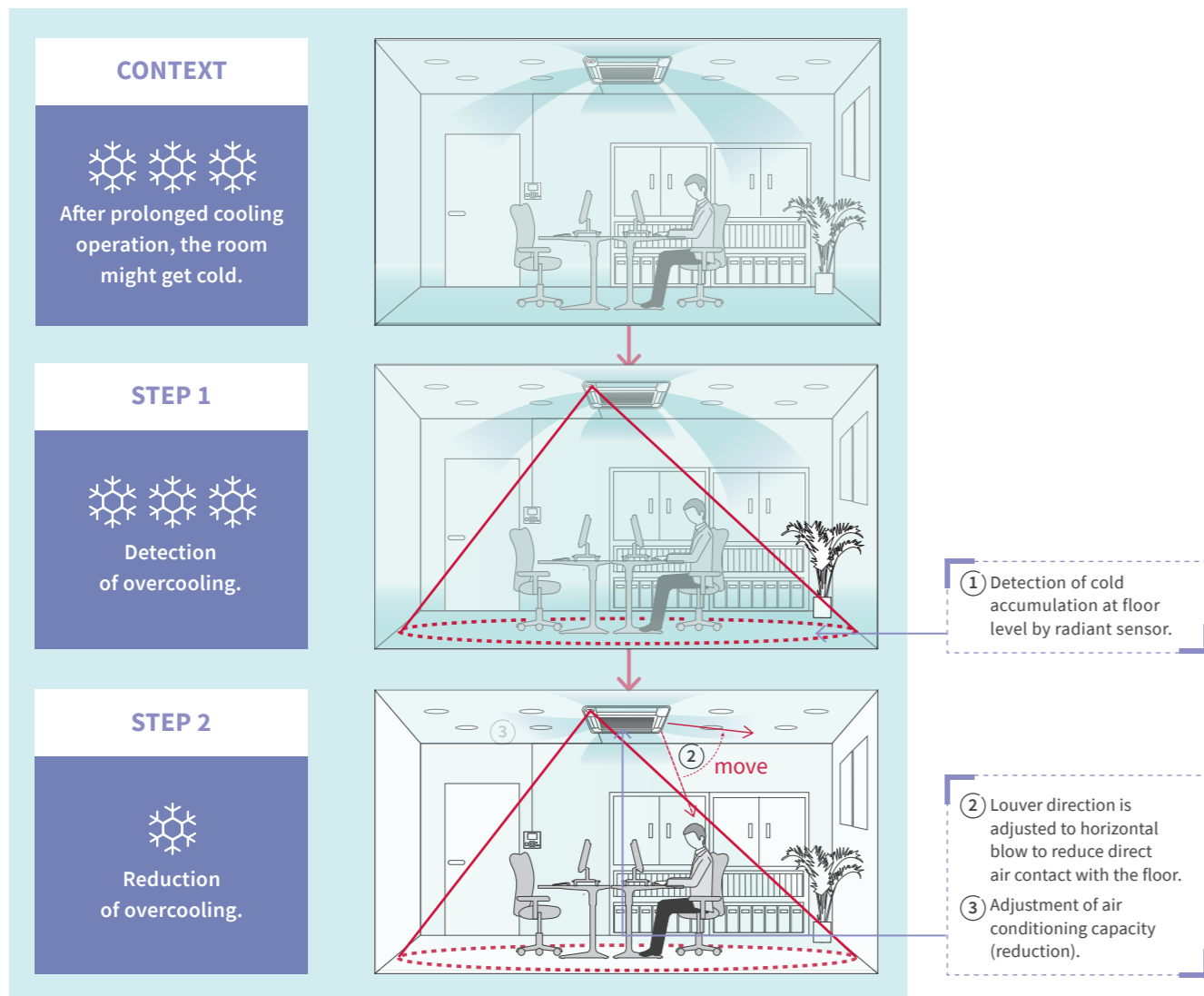

Notes:  
When room vacancy is detected, the air is directed in the way the controller (PC-ARFG) is set up. (Note) 4-zone motion sensor may not be effective in the following cases:  
· If the room is occupied but the movement is minimal, the system might consider the room as vacant.  
· If an object with a temperature different to the surrounding is in motion, it might be considered as human presence.

# Our key indoor features

Hitachi air, making a difference.

## HOTEL SETBACK



Interlock the air conditioner with hotel key card, and set an eco temperature for the time of room vacancy.

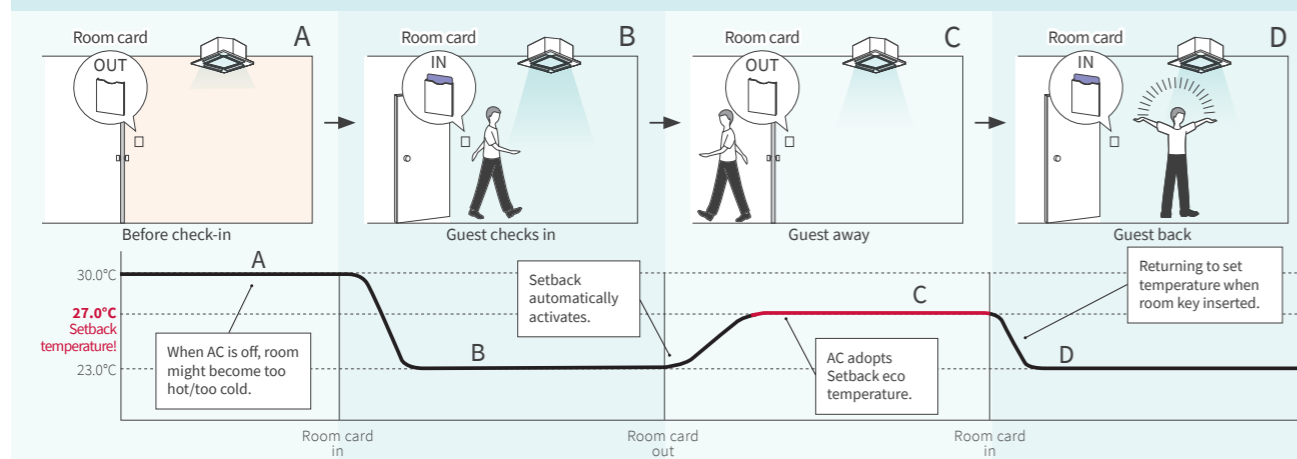

## AUTO-SAVE (WITH MOTION SENSOR)

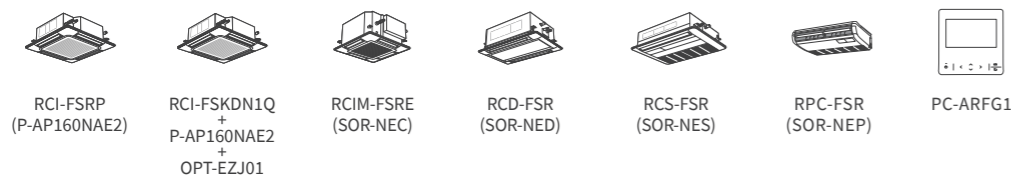

Save more energy while improving comfort!

When adding a motion sensor to the indoor unit, auto-save function will adjust the air conditioning output to the human activity level.

## HOW DOES IT WORK?

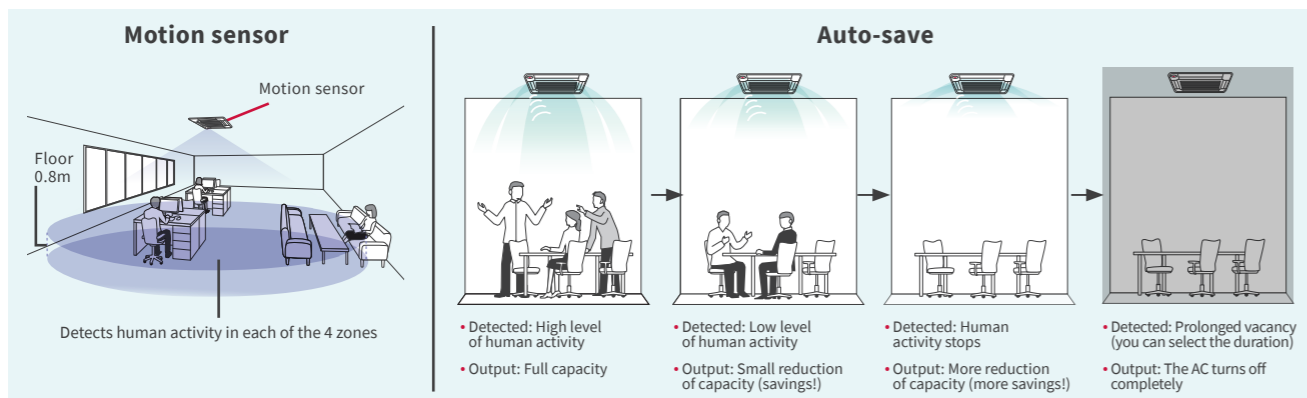

# Indoor Air Quality

Live and work in harmony



## Hitachi IAQ accessory Line-up

	01 ViroSense S filter	02 ViroSense Z2 filter	03 AQtiv-Ion Kit
Type of purchase	Now fitted as standard	Optional upgrade Model: F-160L-ZV	Optional upgrade Model: JK-LAZQ
For those who...	<ul style="list-style-type: none"> <li>want to save additional cost</li> <li>want to create the cleaner indoor environment</li> </ul>	<ul style="list-style-type: none"> <li>want to reduce the risk of secondary infection/pollution reduce spread of SARS-CoV-2</li> <li>don't want to compromise airflow or additional noise</li> </ul>	<ul style="list-style-type: none"> <li>Looking for low-maintenance non-intrusive ways of purifying air without installing separate purification units</li> <li>Looking for both pollutant and odor reduction solutions</li> </ul>
Key Features	<ul style="list-style-type: none"> <li>Lasts up to 5 years (12500h)</li> <li>Anti-virus (&gt;99% inhibition)</li> <li>Anti-bacteria (&gt;99% inhibition)</li> <li>Anti-mold (100% growth stop)</li> </ul>	<ul style="list-style-type: none"> <li>Lasts up to 4 years (10000h)</li> <li>Quick &amp; easy to install/change from existing filters</li> <li>Anti-virus (&gt;99.7% inhibition): better than Ion filter</li> <li>Anti SARS-CoV-2 (&gt;99.9% inhibition)</li> <li>Anti-bacteria (&gt;99% inhibition)</li> </ul>	<ul style="list-style-type: none"> <li>Lasts up to 6 years (15000h)</li> <li>Generates negative ions and emits through AC airflow, which binds to pollutants and odors, sending them harmlessly to the floor</li> <li>Plug &amp; play; converts your ducted IDU into an air-purifying IDU</li> <li>Up to 96.85% capturing of Influenza virus</li> <li>Up to 74.90% removal of Formaldehyde</li> </ul>

STANDARD-EQUIPPED FILTER

## VIROSENSE S FILTER

We have renewed our standard air filter for some of our Hitachi VRF indoor units with leading-edge ion-technology, and, now it has THREE benefits for you & more assures indoor environment. Our STANDARD Air Filter with Ion Purification feature, ViroSense S filter, will catch & reduce them, then help create the cleaner indoor environment.

### ANTI-VIRUS



over 99% Inhibition

### ANTI-BACTERIA



over 99% Inhibition

### ANTI-MOLD



100% growth stop

### Testing information

#### [Anti-virus test]

Test Laboratory: Guangdong Detection Center of Microbiology  
Test Report # 2021FM05008R01  
Test Procedure: Based on ISO 18184:2019  
Textiles - Determination of antiviral activity of textile products

#### [Anti-bacterial test]

Test Laboratory: Guangdong Detection Center of Microbiology  
Test Report # 2021FM05005R01  
Test Procedure: Based on JIS Z 2911:2010  
Antibacterial products-Test for antibacterial activity and efficacy

#### [Anti-mold test]

Test Laboratory: Guangdong Detection Center of Microbiology  
Test Report # 2021FM05006R01  
Test Procedure: Based on JIS Z 2911:2018 (A)  
Methods of test for fungus resistance

## UNIT STANDARDIZED WITH VIROSENSE S FILTER

4-way Cassette (RCI-FSRP)						4-way Cassette (RCI-FSKDN1Q)	
TWIN-SENSE 4-way Panel White	Standard 4-way Panel White	Standard 4-way Panel Black	Silent-Ionic White	Silent-Ionic Auto-elevating grille White	Silent-Ionic Black	Standardized Panel	TWIN-SENSE 4-way Panel White
P-AP160NAE2	P-AP160NA3	P-AP160KA3	P-GP160NAP	P-GP160NAPU	P-GP160KAP	(Standard Equipped)	P-AP160NAE2 + OPT-EZJ01
2-way Cassette (RCD-FSR)		1-way Cassette (RCS-FSR)		Ceiling Suspended (RPC-FSR)			
P-AP90DNA/P-AP160DNA		P-AP36CNA/P-AP56CNA/P-AP80CNA		RPC-1.5FSR~6.0FSR			

Note: for the additional filter purchase, it is treated as "service part". Please consult your distributors.



ViroSense Z2 filter

OPTIONAL ACCESSORY FILTER

## VIROSENSE Z2 FILTER



Model: F-160L-ZV

ViroSense Z2 filter can help reduce the risk of secondary infection in a room. We have confirmed the proven effect that can inhabit certain viruses attached to the air conditioner's filter already before. And in 2022, we have confirmed that it can inhibit the SARS-CoV-2 as well under the laboratory test.

## BENEFITS

<p><b>SARS-CoV-2 Inhibition by over 99.9%</b></p> <p>The efficiency of the ViroSense Z2 filter against SARS-CoV-2 been confirmed with inhibition rate up to more than 99.9%.</p>	<p><b>Virus Inhibition by over 99.7%</b></p> <p>The efficiency of the ViroSense Z2 filter against certain viruses has been confirmed with inhibition rate up to more than 99.7%.</p>	<p><b>Bacteria removal by over 99%</b></p> <p>Efficiency of ViroSense Z2 filter against Certain types of Bacterial has been confirmed too with inhibition rate up to more than 99%.</p>	<p><b>Life span of up to 4 years</b></p> <p>With regular maintenance and cleaning of the filter, the filter can have a life span of up to 4 years.</p>	<p><b>Quick anti-virus transformation</b></p> <p>Your existing 4-way cassette panel can be quickly adapted for the anti-virus version, once you change your existing filter to the ViroSense Z2 filter. The same, usual attachment!</p>
----------------------------------------------------------------------------------------------------------------------------------------------------------------------------------	--------------------------------------------------------------------------------------------------------------------------------------------------------------------------------------	-----------------------------------------------------------------------------------------------------------------------------------------------------------------------------------------	--------------------------------------------------------------------------------------------------------------------------------------------------------	-----------------------------------------------------------------------------------------------------------------------------------------------------------------------------------------------------------------------------------------

## EFFICIENCY PROVEN

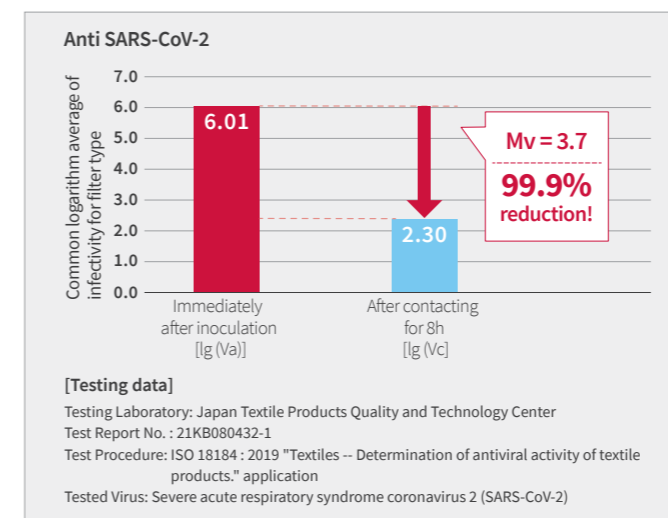

### Anti Virus

#### [Testing data]

Testing Laboratory: Japan Textile Products Quality and Technology Center  
Test Report No. : 20KB-070036  
Tested Target: Feline infectious peritonitis virus ATCC VR-2127  
Test Procedure: Based on ISO 18184; Textiles -- Determination of antiviral activity of textile products  
Effect: Antiviral activity value (Mv) is at least 2.6 (>99.7% inhibition ratio)

### Anti Bacteria

#### [Testing data]

Testing Laboratory: Kaken Test Center  
Test Report: OS-20-09344-1  
Test target: (1) Staphylococcus aureus ATCC 6538 (2) Klebsiella pneumoniae ATCC 4352  
Test procedure: ISO 20743:2013 (Textiles - Determination of antibacterial activity of textile products)  
Effect: Antibacterial activity ratio is at least (1) 2.6 (>99% death ratio) (2) 3.1 (>99.9% death ratio)

## COMPATIBLE INDOOR UNITS WITH VIROSENSE Z2 FILTER

4-way Cassette (RCI-FSRP)						4-way Cassette (RCI-FSKDN1Q)	
TWIN-SENSE 4-way Panel White	Standard 4-way Panel White	Standard 4-way Panel Black	Silent-Ionic White	Silent-Ionic Auto-elevating grille White	Silent-Ionic Black	Standardized Panel	TWIN-SENSE 4-way Panel White
P-AP160NAE2	P-AP160NA3	P-AP160KA3	P-GP160NAP	P-GP160NAPU	P-GP160KAP	(Standard Equipped)	P-AP160NAE2 + OPT-EZJ01

# Indoor Air Quality

Live and work in harmony

OPTIONAL ACCESSORY FILTER  
**AQTIV-ION KIT**



Model: **JK-LZAQ**

Combine your air conditioner with AQtiv-Ion Kit, and provide a better and healthier indoor environment.

Efficient combination with air conditioning

As AQtiv-Ion Kit is integrated into the air conditioning system, AQtiv-Ion Kit does not require its own fan, but uses the airflow from the air conditioner instead. That means, your new air purification device has minimal impact on the noise level and energy consumption, as it fits inside the pre-installed air conditioner.



AQtiv-Ion Kit

## COMMON FACTORS AFFECTING INDOOR AIR QUALITY



Various pathogenic factors including bacteria and certain viruses caused by insufficient ventilation.



Breeding of bacteria, mold and damage to household items, allergies caused by high humidity in wet season.



Formaldehyde, ammonia, benzene and a variety of volatile organic compounds released by decoration materials.



Second-hand smoking and kitchen oil fume.



Dust and mites from fabrics, such as beddings and pet dander might cause allergies.

## HOW AQTIV-ION KIT WORKS



Inactivation of SARS-CoV-2 by more than 99.9%



Up to 96.85% capture of certain viruses and bacteria



Down to PM0.3 micro particle removal



Removal of pollutants



Active oxygen generation

## AQTIV-ION KIT TECHNOLOGY

The AQtiv-Ion Kit generates negative ions, which when released into the air, combine with the oxygen (O<sub>2</sub>) naturally present in the air. These newly created oxygen molecules trap the impure particles, certain viruses and bacteria and deactivate them.

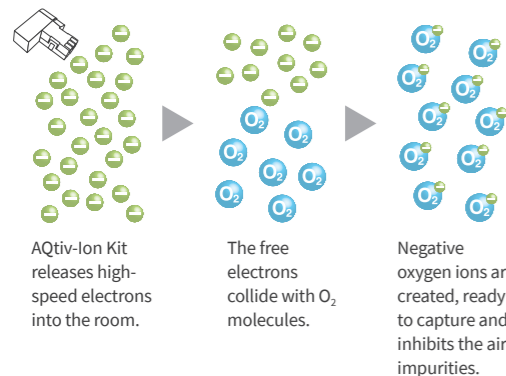

## Fight Against The Multiple Invisibles

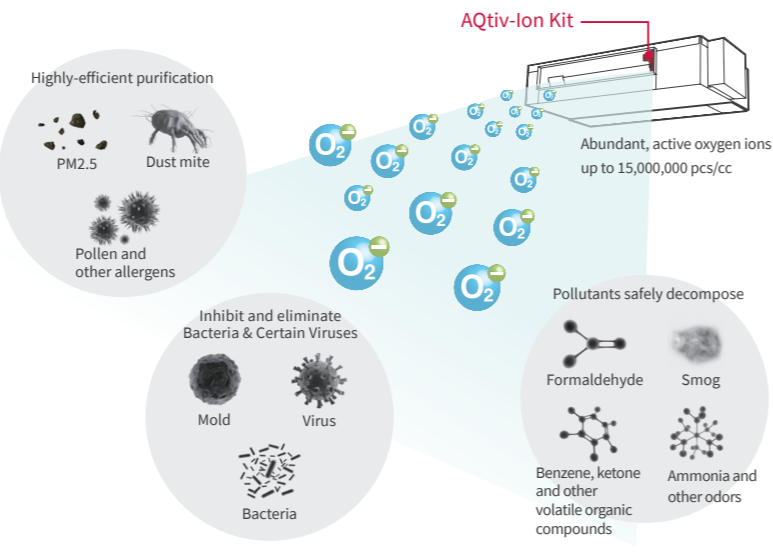

## AQTIV-ION KIT DEACTIVATION PERFORMANCE

SARS-CoV-2  <b>-99.9%</b> (Inhibition rate)	Escherichia coli  <b>-96.64%</b> (Inhibition rate)	Influenza virus  <b>-96.85%</b> (Removal rate)	Staphylococcus aureus  <b>-93.88%</b> (Inhibition rate)	PM2.5  <b>-94.46%</b> (Removal rate)	Formaldehyde  <b>-74.90%</b> (Removal rate)	Ammonia  <b>-73.20%</b> (Removal rate)
------------------------------------------------------	-------------------------------------------------------------	---------------------------------------------------------	------------------------------------------------------------------	-----------------------------------------------	------------------------------------------------------	-------------------------------------------------

## AQTIV-ION KIT APPLICATIONS



Classroom

Condominium

Meeting Room

Hotel

## HOW TO INSTALL?

Plug and play!

Up to your installation condition, you can choose from two options for AQtiv-Ion Kit to be fixed to.

(1) Inside the indoor unit (air outlet)

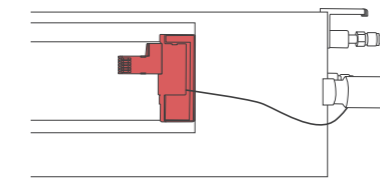

(2) Inside the air duct (air outlet)

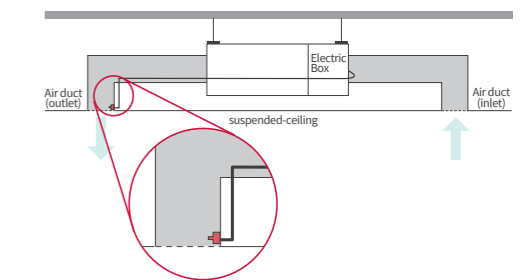

## TECHNICAL SPECIFICATIONS

Model	JK-LZAQ
Wiring Length	1 meter
Rated power supply	220~240V, 50/60Hz
Electrical Power consumption	(Max) 3W
Operating temperature	-10~50 °C
Operating humidity	20~80%RH
Value of negative ion amount	15,000,000 pcs/cc
Certification	CE/CB

## TESTING

### [Escherichia coli] [Staphylococcus aureus]

Laboratory	Guangdong Detection Center of Microbiology
Testing standard	GB 21551.3-2010 Appendix A
Test Report	2019FM10157R01

### [PM2.5]

Laboratory	Guangdong Detection Center of Microbiology
Testing standard	APIAC/LM 01-2015
Test Report	2019FM10157R02

### [Influenza virus]

Laboratory	Guangdong Detection Center of Microbiology
Testing standard	Regulation of disinfection technique in healthcare settings <2002, 2-1-3>
Test Report	2019FM10157R03

### [Formaldehyde] [Ammonia]

Laboratory	Guangdong Detection Center of Microbiology
Testing standard	QB/T2761-2006 etc
Test Report	2019FM10157R04

Please consult your Hitachi Cooling & Heating representative for more details concerning the test reports.

## COMPATIBLE INDOOR UNITS WITH AQTIV-ION KIT

<b>HIGH ESP (AC)</b> <b>RPIH-**HNAUN1Q</b>	<b>HIGH ESP (DC)</b> <b>RPIH-**HNDUSQ</b>	<b>MEIDIUM ESP (AC)</b> <b>RPIM-**HNAUN1Q</b>	<b>LOW ESP (AC)</b> <b>RPIL-**HNAUN1Q</b>	<b>COMPACT (AC)</b> <b>RPIZ-**HNATN1Q</b>	<b>COMPACT (DC)</b> <b>RPIZ-**HNDTS1Q</b>

(\*) For RPI-8.0/10.0FSNQH, please fix the AQtiv-Ion Kit to the indoor unit air-outlet.



# Solutions

Ducted units

## AIR CONDITIONING TURNED INVISIBLE!

Our 6 types of ducted units offer variety of ESP level, to facilitate integration into your project.

NEW



### HIGH ESP (AC) [RPIH-HNAUN1Q, RPI-FSNQ]

- High ESP (90/120/180Pa).
- Slim & space saving design thanks to a height of 300mm only (RPIH-HNAUN1Q).
- Compatible with AQtiv-Ion Kit (Optional accessory)

NEW



### HIGH ESP (DC) [RPIH-HNDUSQ]

- Single-Phase DC motor unit
- Adjustable external pressure up to 150pa
- Compatible with AQtiv-Ion Kit (Optional accessory)

NEW



### MEDIUM ESP (AC) [RPIH-HNAUN1Q, RPI-FSN3Q]

- Medium ESP: 50/80Pa (0.8-2.5HP) or 100Pa (8.0-10.0HP).
- Slim & space saving design thanks to a height of 270mm only (0.8-2.5HP) or 470mm only (8.0-10.0HP).
- Compatible with AQtiv-Ion Kit (Optional accessory)

NEW



### LOW ESP (AC) [RPIH-HNAUN1Q]

- Low ESP (30Pa for 0.8-2.5HP, 60Pa for 3.0-6.0HP).
- Space saving design thanks to a height of only 270mm (0.8-2.5HP) or 350mm (3.0-6.0HP).
- Compatible with AQtiv-Ion Kit (Optional accessory)

NEW

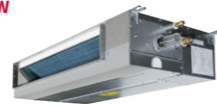

### COMPACT (AC) [RPIZ-HNATN1Q]

- 192mm height! Ideal for installations above closets or windows.
- Drain-pump with 900mm lift as standard optional part.
- Quiet noise level down to 20dB(A).
- Compatible with AQtiv-Ion Kit (Optional accessory)

NEW



### COMPACT (DC) [RPIZ-HNDTS1Q]

- 192mm height! Ideal for installations above closets or windows.
- Drain-pump with 900mm lift as standard optional part.
- Quiet noise level down to 20dB(A).
- Fan speed: 6 taps available.
- Compatible with AQtiv-Ion Kit (Optional accessory)

## FROM 2.2KW TO 28KW

Ducted indoor units	Cooling (kW)	2.2	2.8	3.6	4.0	4.3	5.0	5.6	6.3	7.1	8.4	9.0	11.2	14.2	16.0	22.4	23.2	28.0	28.6
<b>NEW</b> HIGH ESP (AC) [RPIH-HNAUN1Q, RPI-FSNQ]											●	●	●	●	●	●		●	
<b>NEW</b> HIGH ESP (DC) [RPIH-HNDUSQ]																	●		●
<b>NEW</b> MEDIUM ESP (AC) [RPIH-HNAUN1Q, RPI-FSN3Q]		●	●	●		●	●	●	●	●						●		●	
<b>NEW</b> LOW ESP (AC) [RPIH-HNAUN1Q]		●	●	●		●	●	●	●	●	●	●	●	●	●				
<b>NEW</b> COMPACT (AC) [RPIZ-HNATN1Q]		●	●	●	●		●	●	●	●									
<b>NEW</b> COMPACT (DC) [RPIZ-HNDTS1Q]		●	●	●	●		●	●	●	●									

## FEATURES COMPARISON

Model	NEW HIGH ESP (AC) RPIH-HNAUN1Q	NEW HIGH ESP (DC) RPIH-HNDUSQ	HIGH/MEDIUM ESP (8/10HP) (AC) RPI-FSNQ RPI-FSN3Q	NEW MEDIUM/LOW ESP (AC) RPIH-HNAUN1Q RPIH-HNAUN1Q	NEW COMPACT (AC) RPIZ-HNATN1Q	NEW COMPACT (DC) RPIZ-HNDTS1Q
Temperature Setting Rate	1.0°C	1.0°C	1.0°C	1.0°C	1.0°C	1.0°C
Fan Speed	3 taps	6 taps	1 tap	3 taps	3 taps	6 taps
Louver Direction	-	-	-	-	-	-
Individual Louver Setting	-	-	-	-	-	-
Auto Louver Setting	-	-	-	-	-	-
Dry mode Availability	●	●	●	●	●	●
Setback (Away Function)	-	-	-	-	-	-
Cold Draft Prevention (*1)(*4)	●	●	●	●	●	●
Comfort setting Control Cool Air (GentleCool) (*2)	-	-	-	-	-	-
Direct/Indirect louver direction in COOL	-	-	-	-	-	-
FloorSense Cool air flow control	-	-	-	-	-	-
Power Saving with Motion Sensor (*2)	-	-	-	-	-	-
Outdoor Unit capacity control (*2)	Peak cut control	-	-	-	-	-
	Moderate control	-	-	-	-	-
Indoor Unit Rotation Control (*2)	Indoor Unit Address	-	-	-	-	-
	Indoor Air Temperature difference	-	-	-	-	-
Automatic Fan Operation	●	●	●	●	●	●
AutoBoost (quick function) (*2)	-	-	-	-	-	-
Daylight Saving Time	●	●	●	●	●	●
Power Consumption visualization (*2)	-	-	-	-	-	-
Weekly Schedule Setting	●	●	●	●	●	●
Power-Saving Setting (*2)	-	-	-	-	-	-
Filter cleaning reminder	●	●	●	●	●	●
Check Menu	Sensor Condition Check	●	●	●	●	●
	Model Display (*2)	-	-	-	-	-
	Indoor/Outdoor PCB Check	●	●	●	●	●
Alarm History Display	●	●	●	●	●	●
Motion Sensor	-	-	-	-	-	-
Receiver Kit for wireless remote controller	PC-RLH11 PC-ALHZ1	PC-RLH11 PC-ALHZ1	PC-RLH11 PC-ALHZ1	PC-RLH11 PC-ALHZ1	PC-RLH11 PC-ALHZ1	PC-RLH11 PC-ALHZ1
Drain-up mechanism availability	DUPI-361Q	DUPI-810AQ	DUPI-15H2Q	DUPI-131Q DUPI-361Q	● (*3)	● (*3)
Air filter	KW-PP9/10Q	KW-PP14Q F-10LPIE F-10HP1E	-	KW-PP7/ 8/9/10Q	KW-PP5Q KW-PP6Q	KW-PP5Q KW-PP6Q
AQtiv-Ion Kit	●	●	-	●	●	●

(\*1) This function is utilized to prevent cold discharged air at start-up of heating operation, after defrosting operation, etc.  
 (\*2) Advanced wired remote controller PC-ARF1 needs to be connected.  
 (\*3) Included as standard equipment.  
 (\*4) Please consult your distributor.

### AQtiv-Ion Kit



### Leads to the better Indoor Air Quality

- Features**
- Up to 96.85% capture of viruses and bacteria
  - Down to PM0.3 micro particle removal
  - Pollutant removal
  - Active oxygen generation
  - Inactivation of SARS-CoV-2 by more than 99.9%

# Success that sparks

NEW



**Information**  
 Labs Tower Cyprus  
 FFOTI PITTA 4, CYPRUS, 1065  
<https://labstower.cy/>

## General Information

Year of installation : 2022  
 Project type : Retrofit  
 Vertical application: Commercial multi-tenant building  
 Installed unit :  
 Total 384HP With all Ducted Indoor Units



# Solutions

Ducted units

NEW

**HIGH ESP** HIGH EXTERNAL STATIC PRESSURE  
 (AC) [RPIH-HNAUN1Q, RPI-FSNQ]



- 1) High ESP. (90/120/180Pa)
- 2) Space saving design thanks to a height of only 300mm. (RPIH-HNAUN1Q)
- 3) Flexible installation. Options allow for multiple configurations.
- 4) Optional drain pump. Drain-up mechanism can be supplied as optional part.
- 5) Compatible with AQtiv-Ion Kit (Optional accessory)

③ L-shaped space

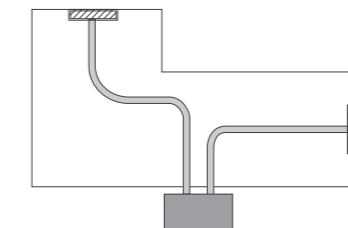

U-shaped space

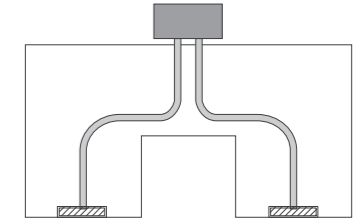

④

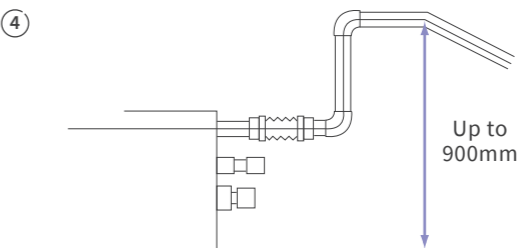

NEW

**HIGH ESP** HIGH EXTERNAL STATIC PRESSURE  
 (DC) [RPIH-HNDUSQ]



- 1) High external pressure up to 150Pa
- 2) Flexible installation allowing for multiple configurations
- 3) Optional drain-pump: Drain-up mechanism can be supplied as optional accessory
- 4) Compatible with AQtiv-Ion Kit (Optional accessory)

② L-shaped space

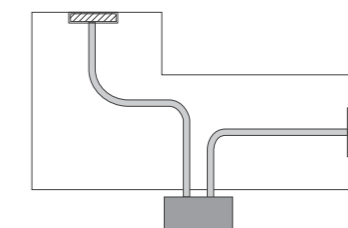

U-shaped space

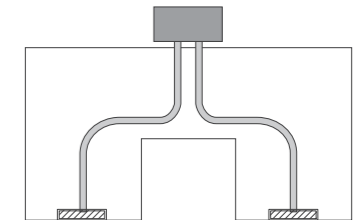

③

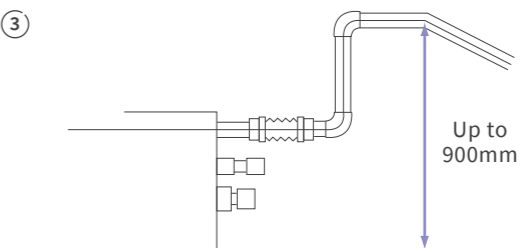

# Solutions

## Ducted units



NEW

### MEDIUM ESP MEDIUM EXTERNAL STATIC PRESSURE

(AC) [RPIM-HNAUN1Q, RPI-FSN3Q]

- 1) Medium ESP. (50/80Pa for 0.8-2.5HP class, 100Pa for 8.0-10.0HP class)
- 2) Space saving design thanks to a height of only 270mm. (0.8-2.5HP class) or 470mm (8.0-10.0HP class)
- 3) Flexible installation. Options allow for multiple configurations.
- 4) Optional drain pump. Drain-up mechanism can be supplied as optional part.
- 5) Compatible with AQtiv-Ion Kit (Optional accessory)

③ L-shaped space

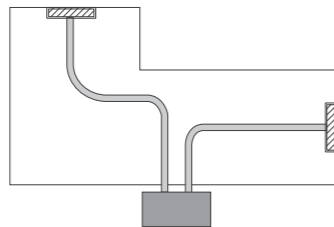

U-shaped space

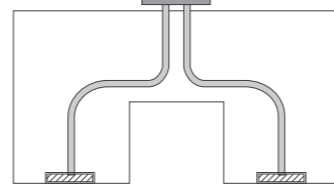

④

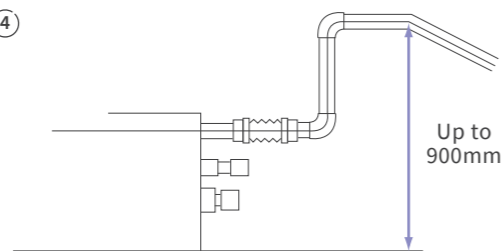

NEW

### LOW ESP (LOW EXTERNAL STATIC PRESSURE)

(AC) [RPIL-HNAUN1Q]

- 1) Low ESP. (30Pa for 0.8-2.5HP class, 60Pa for 3.0-6.0HP class)
- 2) Space saving design thanks to a height of only 270mm (0.8-2.5HP class) or 300mm (3.0-6.0HP class).
- 3) Optional drain pump. Drain-up mechanism can be supplied as optional part.
- 4) Compatible with AQtiv-Ion Kit (Optional accessory)

③

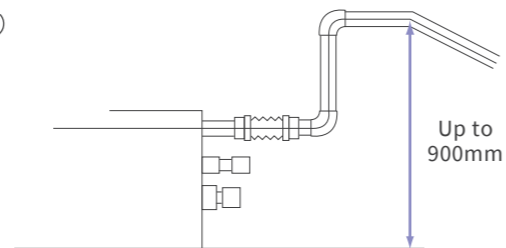

NEW

### COMPACT

(AC) [RPIZ-HNATN1Q]

- 1) Ideal for installation over closets or windows thanks to a more compact design, 192mm high.
- 2) Drain-pump with 900mm lift as standard optional part.
- 3) Quiet operation level. (as low as 20dB(A))
- 4) Fan air flow rate up to 6 taps. (DC motor model only)
- 5) Compatible with AQtiv-Ion Kit (Optional accessory)



①

Over a closet

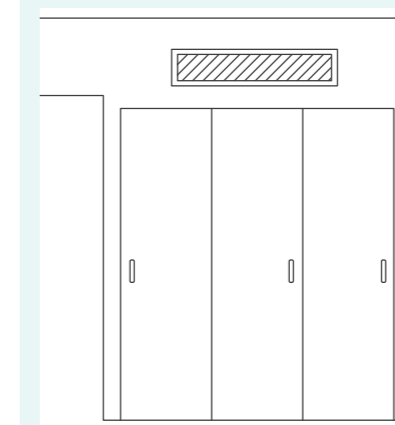

In dropped ceiling, over window

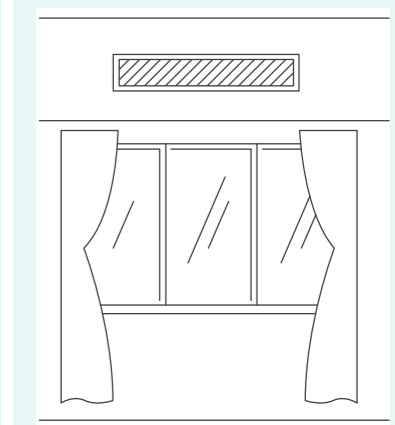

NEW

### COMPACT

(DC) [RPIZ-HNDTS1Q]

- 1) Ideal for installation over closets or windows thanks to a more compact design, 192mm high.
- 2) Drain-pump with 900mm lift as standard optional part.
- 3) Quiet operation level. (as low as 22.5dB(A))
- 4) Fan air flow rate up to 6 taps. (DC motor model only)
- 5) Compatible with AQtiv-Ion Kit (Optional accessory)

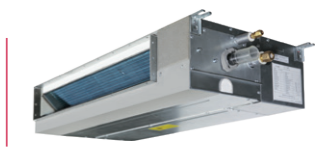

①

Over a closet

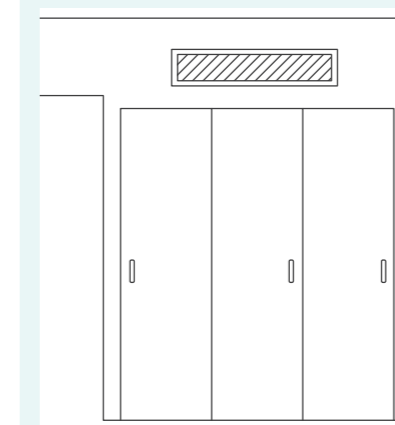

In dropped ceiling, over window

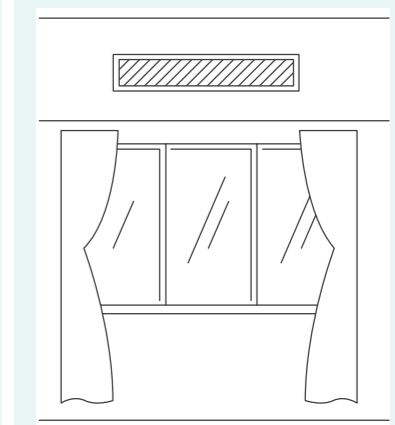

# Solutions

Ceiling cassettes

## PREMIUM DESIGN & INNOVATIVE FEATURES

Meet with our newly upgraded offer, for upgraded comfort!



### 4-WAY CASSETTE (DC) [RCI-FSRP]

- (with P-AP160NAE2)
  - Greater performance & Greater comfort can be achieved
- (with P-GP160NAP)
  - Award-winning Silent-Iconic™ to fit your indoor aesthetics.
  - We have also Black type Silent-Iconic™, and, Gray/Beige normal panel.
- (with P-GP160NAPU)
  - Maintenance will be enormously improved by the auto-elevation grille.
  - Compatible with ViroSense Z2 filter!
  - ViroSense S filter as standard!



Color variation (RCI-FSRP)



Silent-Iconic™ with elevation grille

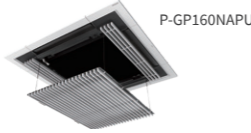

### 4-WAY COMPACT CASSETTE (DC) [RCIM-FSRE]

- Made to give you greater design flexibility as the dimensions fit 600mm×600mm architectural module ceiling specifications
- Quiet operation level (as low as 24.5dB(A))
- Wide range of air flow rate ideal for high ceiling installation with 4.6m air blow down in cooling mode
- Setback temperature control available, leading to better operation.
- Motion sensor available for better energy saving operation
- GentleCool control to ensure you are not bothered by cold draft



### 2-WAY CASSETTE (DC) [RCD-FSR]

- Motion sensor available for better energy saving operation
- Ideal for a higher ceiling location for installation (up to 4.6m in cooling mode)
- Individually operated louvers give room occupants more comfort
- Quiet operation level (as low as 27dB(A))
- Setback temperature control available, leading to better operation.
- GentleCool control to ensure you are not bothered by cold draft
- ViroSense S filter as standard!



### 1-WAY CASSETTE (DC) [RCS-FSR]

- Motion sensor available for better energy saving operation
- Optimum air flow conditions are created by either downward air discharge or frontal air discharge (via optional grille) or a combination of both
- Quiet operation level (as low as 27dB(A))
- Setback temperature control available, leading to better operation.
- GentleCool control to ensure you are not bothered by cold draft
- ViroSense S filter as standard!



### 4-WAY CASSETTE (DC) [RCI-FSKDN1Q]

- With area of air distribution with 7 directions of louvers (distribution with distance available with optional parts (duct flange))
- Individual four-way louvers for greater comfort for individual users
- Ideal for a higher ceiling location for installation (up to 5.5m in cooling mode)
- Setback temperature control available, leading to better operation.
- GentleCool control to ensure you are not bothered by cold draft
- Compatible with ViroSense Z2 filter!
- ViroSense S filter as standard!

## FROM 1.6KW TO 16KW

Ceiling cassettes	Cooling (kW)	1.6	2.2	2.8	4.0	5.6	6.3	7.1	8.0	11.2	14.0	16.0
4-WAY CASSETTE (DC) [RCI-FSRP]				●	●	●		●	●	●	●	●
<b>NEW</b> 4-WAY CASSETTE (DC) [RCI-FSKDN1Q]				●	●	●	●	●	●	●	●	●
4-WAY COMPACT CASSETTE (DC) [RCIM-FSRE]		●	●	●	●	●		●				
2-WAY CASSETTE (DC) [RCD-FSR]			●	●	●	●		●	●	●	●	●
1-WAY CASSETTE (DC) [RCS-FSR]			●	●	●	●		●	●			

## FEATURES COMPARISON

Model	4-WAY CASSETTE TYPE (DC MOTOR TYPE)		4-WAY CASSETTE COMPACT TYPE (DC MOTOR TYPE)	2-WAY CASSETTE TYPE (DC MOTOR TYPE)	1-WAY CASSETTE TYPE (DC MOTOR TYPE)
	RCI-FSRP	RCI-FSKDN1Q	RCIM-FSRE	RCD-FSR	RCS-FSR
Temperature Setting Rate	0.5°C/1.0°C	0.5°C/1.0°C	0.5°C/1.0°C	0.5°C/1.0°C	0.5°C/1.0°C
Fan Speed	4 taps	4 taps	4 taps	4 taps	4 taps
Louver Direction	7 (*4)	7 (*4)	7 (*4)	7 (*4)	7 (*5)
Individual Louver Setting	●	●	●	●	-
Auto Louver Setting	●	●	●	●	●
Dry mode Availability	●	●	●	●	●
Setback (Away Function)	●	●	●	●	●
Cold Draft Prevention Availability (*1)	●	●	●	●	●
Comfort setting Control Cool Air (GentleCool) (*2)	●	●	●	●	●
Direct/Indirect louver direction in COOL	●	●	-	-	-
FloorSense Cool air flow control	●	●	-	-	-
ViroSense S filter as standard	P-AP160NAE2 P-AP160NA3 P-AP160KA3 P-GP160NAP P-GP160NAPU P-GP160KAP	Standard Decoration panel P-AP160NAE2	-	P-AP90DNA P-AP160DNA	P-AP36CNA P-AP56CNA P-AP80CNA
Power Saving with Motion Sensor (*2)	●	●	●	●	●
Outdoor Unit capacity control (*2)	Peak cut control ●	Moderate control ●	●	●	●
Indoor Unit Rotation Control (*2)	Indoor Unit Address ●	Indoor Air Temperature difference ●	●	●	●
Automatic Fan Operation	●	●	●	●	●
AutoBoost (quick function) (*2)	●	●	●	●	●
Daylight Saving Time	●	●	●	●	●
Power Consumption visualization (*2)	●	●	●	●	●
Weekly Schedule Setting	●	●	●	●	●
Power-Saving Setting (*2)	●	●	●	●	●
Filter cleaning reminder	●	●	●	●	●
Check Menu	Sensor Condition Check ●	Model Display (*2) ●	Indoor/Outdoor PCB Check ●	Alarm History Display ●	●
Colored Panel availability	● (*6)	-	-	● (*6)	● (*6)
Motion Sensor	P-AP160NAE2	P-AP160NAE2	SOR-NEC	SOR-NED	SOR-NES
Receiver Kit for wireless remote controller	PC-ALH3	HR4A10NEWQ PC-ALH3	PC-ALHC1	PC-ALHD1	PC-ALHS1
Drain-up mechanism availability	● (*3)	● (*3)	● (*3)	● (*3)	● (*3)
Fresh air intake accessory	● (*7)	-	● (*7)	● (*7)	● (*7)
Decoration Panel	P-AP160NAE2 P-AP160NA3 P-AP160KA3	Standard	P-AP56NAM P-AP56NAMR	P-AP90DNA P-AP160DNA	P-AP36CNA P-AP56CNA P-AP80CNA
Design Panel Silent-Iconic	P-GP160NAP P-GP160NAPU P-GP160KAP	P-GP160NAP P-GP160NAPU P-GP160KAP	-	-	-
ViroSense Z2 filter (optional) compatible with	P-AP160NAE2 P-AP160NA3 P-AP160KA3 P-GP160NAP P-GP160NAPU P-GP160KAP	Standard Decoration panel P-AP160NAE2	-	-	-
Air filter	F-71L-D1 F-160L-D1 B-160H3	-	-	F-90MD-K1 F-160MD-K1 B-90HD B-160HD	-

(\*1) You can use this function to prevent cold discharged air at startup of the heating...  
 (\*2) Advanced wired remote controller PC-ARF1 needs to be connected.  
 (\*3) Included as standard equipment.  
 (\*4) 7 angles are available for individual louver setting, 5 angles only for the operation of Cooling or Dry.  
 (\*5) 5 steps only for the operation of Cooling or Dry.  
 (\*6) 3 colors are available (Beige, Grey, and Black).  
 (\*7) A Duct Adapter (Optional part) is available.

#### ViroSense S filter



**Features**

- New filter as standard
- Lasts up to 5 years (12500h)
- Anti-virus (>99% inhibition)
- Anti-bacteria (>99% inhibition)
- Anti-mold 100% growth stop

#### ViroSense Z2 filter



**Features**

- Optional Accessory
- Lasts up to 4 years (10000h)
- Quick & easy to install/change from existing filters
- Anti-virus (>99.7% inhibition); better than Ion filter
- Anti SARS-CoV-2 (>99.9% inhibition)

# Solutions

Ceiling cassettes

## SILENT-ICONIC™ 4-WAY CASSETTE DESIGN PANEL



Exclusive panel: architectural designers will love it!



reddot winner 2021  
best of the best

[Silent-ionic] receives Red Dot: Best of the Best for ground-breaking design quality



iF Design Award 2020  
Award Winning  
(Discipline: Product)



GOOD DESIGN AWARD 2020  
Good Design Award  
(Category: Equipment and facilities for professional use)

Tomohiko Sato  
Hitachi, Ltd. Product Design Department, Senior Designer



The designer graduated from University in the United Kingdom and soon after, he joined a London based design studio, working across a wide variety of disciplines including furniture, interior and the public realm. Currently, he dedicates himself to air conditioning design, working as a Senior Designer in the Hitachi product design department in Hitachi, Ltd.



The design is well-matched to the space

It is designed to harmonize with the space by creating the central part to be a blind shaped air-inlet port and reducing its occupied presence by darkening the air-outlet port.

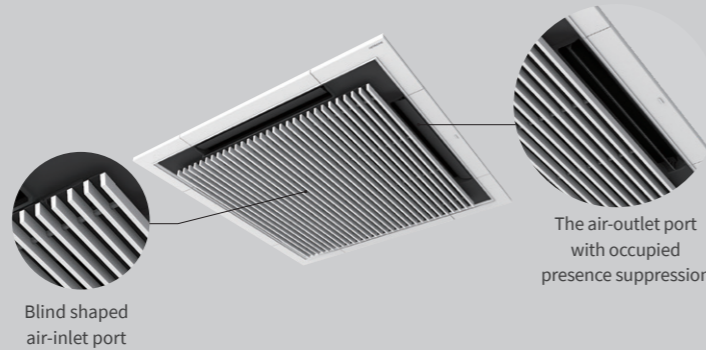

Blind shaped air-inlet port

The air-outlet port with occupied presence suppression



# Success that sparks

NEW

DondiSalotti

### Shop information

Dondi Salotti  
Via Camillo Cavour 57 Gaglianico, Biella, Italia  
dondisalotti.com

### General Information

Year of installation : 2022  
Project type : Retrofit  
Vertical application: Furniture shop  
Installed unit : Total 32HP, (10 units of Silent-Iconic 4-way Cassette)



# Solutions

Ceiling cassettes





NEW

## 4-WAY CASSETTE

(DC) [RCI-FSRP, RCI-FSKDN1Q]

### DECORATION PANEL LINE-UP

Normal	Smart	Aesthetics	Maintenance
Standard	with motion sensor + radiant temperature sensor	Color Panel Design Panel	Silent-Iconic™ with Elevation Grille
P-AP160NA3	P-AP160NAE2	-	P-GP160NAPU
		Standard (Custom Order) Beige Gray Black Silent-Iconic™ White Black P-GP160NAP P-GP160KAP	
(H×W×D) 40×950×950(mm)	(H×W×D) 40×950×950(mm)	Standard (H×W×D) 40×950×950(mm) Silent-Iconic™ (H×W×D) 52×950×950(mm)	(H×W×D) 52×950×950(mm)
RCI-FSRP	RCI-FSRP, RCI-FSKDN1Q	RCI-FSRP	RCI-FSRP

## TWIN-SENSE CASSETTE

Adaptive comfort for real life.

### EXCLUSIVE GENTLECOOL

(standard feature)  
During cooling, the anti cold-draft control function prevents the perception of a cold draft in the discharged air temperature.

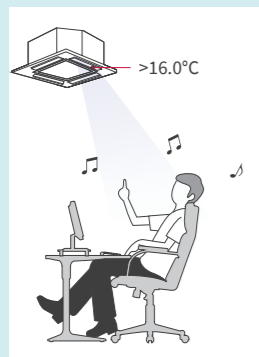

### FLOORSENSE COOL

(with radiant temperature sensor)  
During cooling, based on indoor unit's new radiant sensor, the multi-louvers adjust to the precise airflow position and cooling capacity to prevent the cold air from sinking and overcooling the floor area.

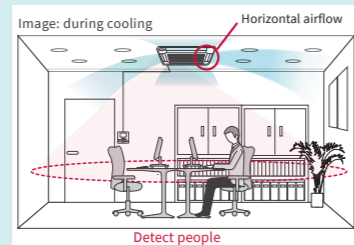

### EXCLUSIVE CROWD-SENSE

(with motion sensor + radiant temperature sensor)  
When detecting an increase of occupants in the room, Twin-Sense anticipates the additional heat source of human bodies. The cassette immediately and proactively adjusts operation for a more stable indoor temperature.



## 4-WAY COMPACT CASSETTE

(DC) [RCIM-FSRE]



① Ideal for suspended ceilings.

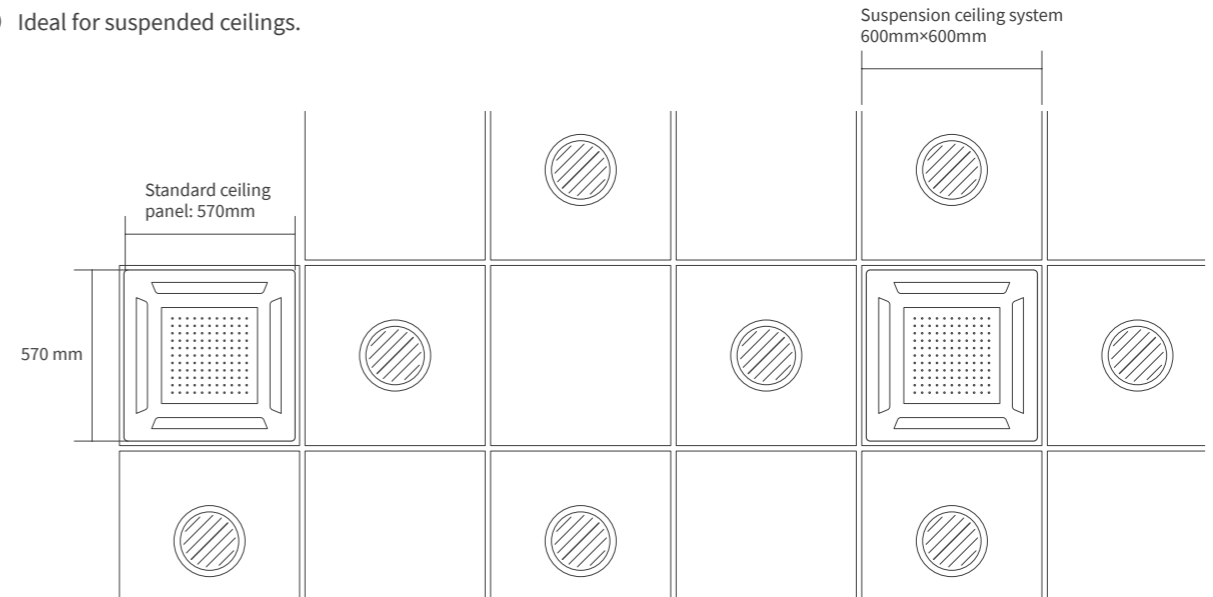

The 600x600 unit can fit in between lighting panels without any disruption.

② Whisper quiet sound level.

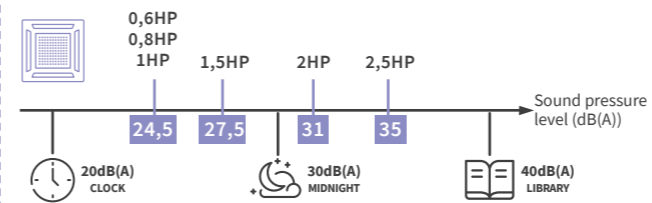

④ Suitable for high ceilings.  
Standard drain pump: up to 850mm lift.

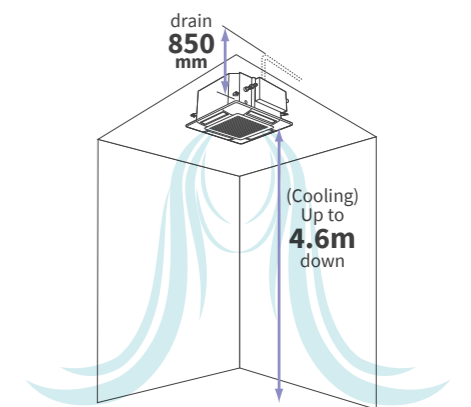

\* Air flow rate: HI2  
\* 2.0-2.5 FSRE

③ Esthetics.

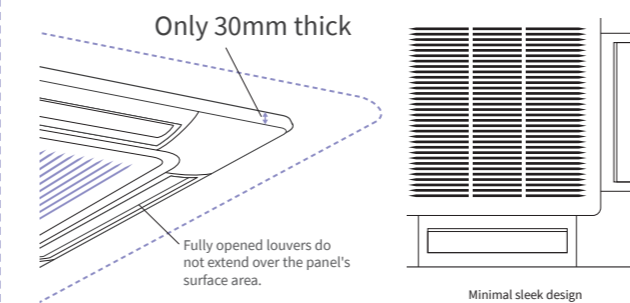

# Solutions

## Ceiling cassettes



### 2-WAY CASSETTE

(DC) [RCD-FSR]

- ① Individually controlled louvers.  
Tailor the air flow direction to both ends of the room.

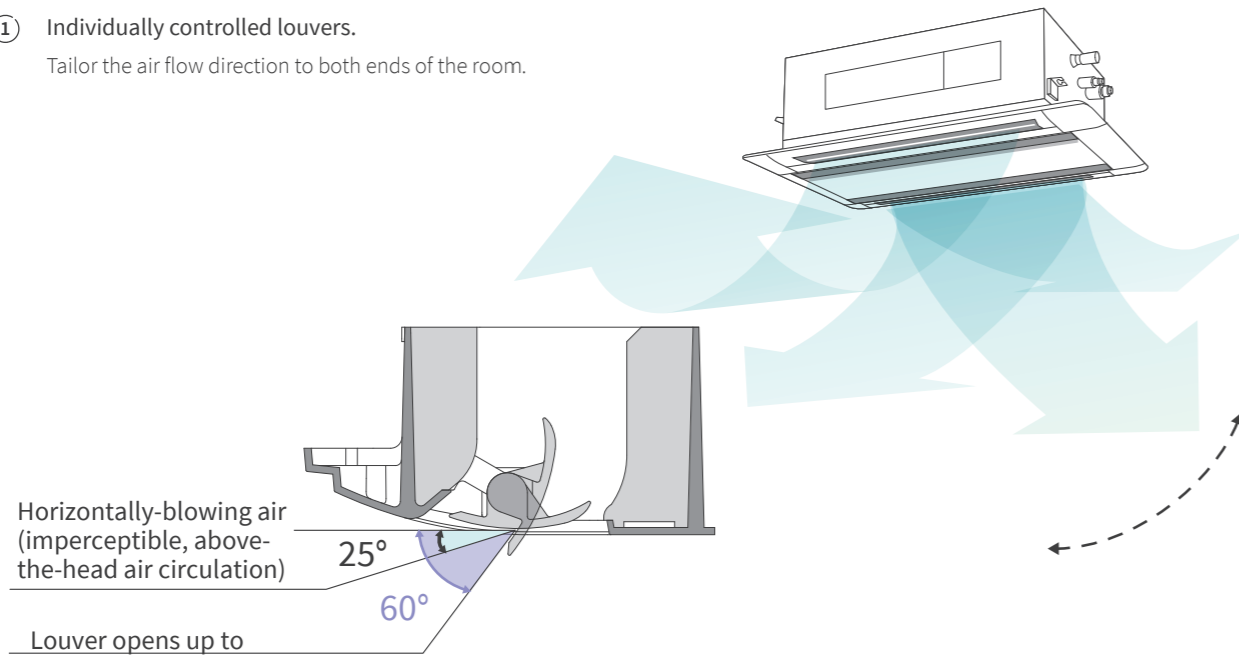

- ② Facilitated installation.

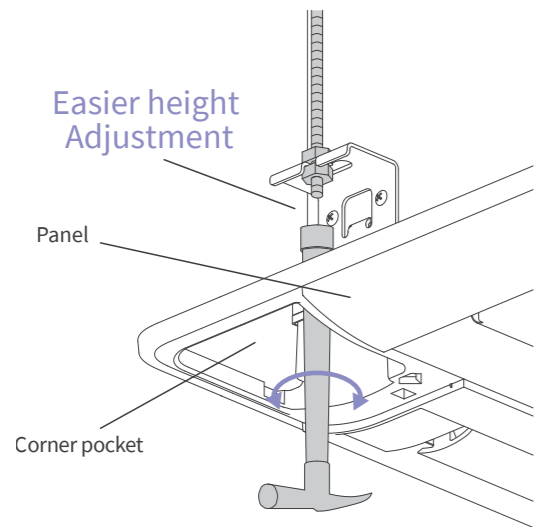

- ③ Suitable for high ceilings.

Standard drain pump: up to 850mm rise.

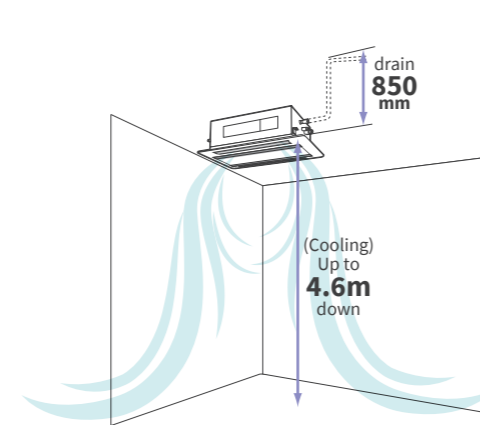

\* Air flow rate: Hi2  
\* 2.0-6.0 FSR

### 1-WAY CASSETTE

(DC) [RCS-FSR]



- ① 3 types of installation.

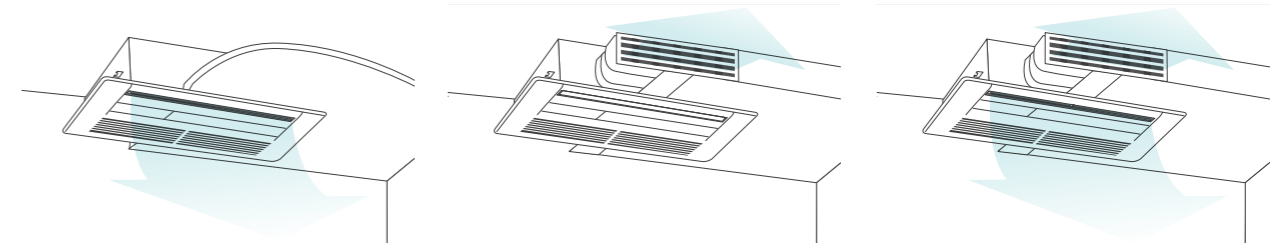

**In corner with open louvers (typical).**  
Allows for ceiling planning for lighting and interiors, suitable for installation near the window.

**With closed louvers & ceiling horizontal vent.**

Suitable for design that focuses on lighting and suspended ceilings, in case the unit is unable to be directly embedded in the ceiling.

**Open louver & ceiling horizontal vent.**

Get two directions with 1-way cassette! Connect the cassette with a horizontal vent on the side, and create both downward air flow and horizontal air flow at the same time.

- ② Whisper quiet sound level.

Reduced sound pressure thanks to new design in fan inlet and fan.

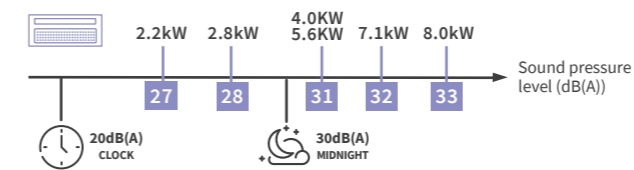

- ④ Suitable for high ceilings.  
Standard drain pump: up to 850mm lift.

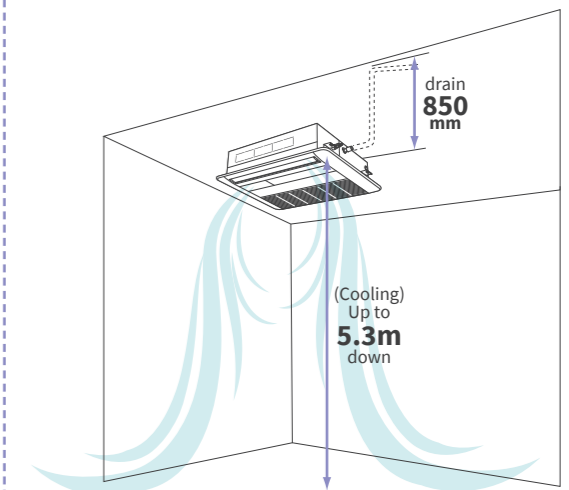

\* Air flow rate: Hi2  
\* 2.5-3.0 FSR  
\* standard corner type

# Solutions

Other indoor units

## WIDE RANGE OF MODELS FOR MINIMAL INSTALLATION WORKS

Hitachi range offers our widest choice of indoor units to give you the versatility to complement any interior.



### WALL MOUNTED (DC) [RPK-FSRM]

- Simple installation procedure
- Flexible discreet design suitable for any interior
- Setback temperature control available, leading to better operation.
- GentleCool control to ensure you are not both



### WALL MOUNTED (DC) [RPK-HNBUSQ]

- Economic choice for any type of room
- Display set-temperature and operation status on front cover by LED



### FLOOR/CEILING CONVERTIBLE (AC) [RPFC-FSNQ]

- Each unit can be floor mounted or ceiling suspended
- Easy installation
- Fresh air-intake design



### CEILING SUSPENDED (DC) [RPC-FSR]

- Ideal for a higher ceiling (up to 5.6m in cooling)
- Better power-saving with optional Motion Sensor
- Quiet operation level (as low as 28dB(A))
- Setback temperature control available, leading to better operation.
- GentleCool control to ensure you are not bothered by cold draft
- ViroSense S filter as standard!



### FLOOR CONCEALED (AC) [RPFI-FSNQ]

- Ideal for spaces without ceiling plenum, can be visually hidden in floor cavities and along the walls.
- Space saving slim unit (only 202/220mm deep).
- Only 620mm high, ideal for under-the-window installation.

## FROM 1.7KW TO 16KW

### Concealed & exposed indoor units

	Cooling (kW)	2.2	2.8	3.6	4.0	4.3	5.0	5.6	6.3	7.1	8.0	8.4	9.0	11.2	14.0	14.2	16.0
WALL MOUNTED (DC) [RPK-FSRM]										●	●			●			
WALL MOUNTED (DC) [RPK-HNBUSQ]		●	●	●	●		●	●	●	●							
FLOOR / CEILING CONVERTIBLE (AC) [RPFC-FSNQ]							●	●	●	●		●	●	●		●	
CEILING SUSPENDED (DC) [RPC-FSR]					●			●		●	●			●	●		●
FLOOR CONCEALED (AC) [RPFI-FSNQ]		●				●		●		●							

## FEATURES COMPARISON

Model	WALL MOUNTED		FLOOR/CEILING CONVERTIBLE	CEILING SUSPENDED	FLOOR CONCEALED
	RPK-FSRM	RPK-HNBUSQ	RPFC-FSNQ	RPC-FSR	RPFI-FSNQ
Temperature Setting Rate	0.5°C/1.0°C	1.0°C	1.0°C	0.5°C/1.0°C	1.0°C
Fan Speed	4 taps	6 taps	3 taps	4 taps	3 taps
Louver Direction	7 (*5)	7 (*5)	7 (*5)	7 (*5)	-
Individual Louver Setting	-	-	-	-	-
Auto Louver Setting	-	●	-	-	-
Dry mode Availability	●	●	●	●	●
Setback (Away Function)	●	-	-	●	-
Cold Draft Prevention Availability (*1)(*6)	●	-	●	●	●
Comfort setting Control Cool Air (GentleCool) (*2)	●	-	-	●	-
Direct/Indirect louver direction in COOL	-	-	-	-	-
FloorSense Cool air flow control	-	-	-	-	-
Power Saving with Motion Sensor (*2)	-	-	-	●	-
Outdoor Unit capacity control (*2)	Peak cut control	●	-	●	-
	Moderate control	●	-	●	-
Indoor Unit Rotation Control (*2)	Indoor Unit Address	●	-	●	-
	Indoor Air Temperature difference	●	-	●	-
Automatic Fan Operation	●	●	●	●	●
AutoBoost (quick function)	●	-	-	●	-
Daylight Saving Time	●	●	●	●	●
Power Consumption visualization (*2)	●	-	-	●	-
Weekly Schedule Setting	●	●	●	●	●
Power-Saving Setting (*2)	●	-	-	●	-
Filter cleaning reminder	●	●	●	●	●
Check Menu	Sensor Condition Check	●	●	●	●
	Model Display (*2)	-	-	-	●
	Indoor/Outdoor PCB Check	●	●	●	●
	Alarm History Display	●	●	●	●
Motion Sensor	-	-	-	SOR-NEP	-
Receiver Kit for wireless remote controller	PC-ALHZ1	PC-RLH11 (*6) PC-ALHZ1	PC-RLH11 (*6) PC-ALHZ1	PC-ALHP1	PC-RLH11 (*6) PC-ALHZ1
Drain-up mechanism availability	-	-	-	DUPC-63K1 DUPC-71K1 DUPC-160K1	-
ViroSense S filter	-	-	-	●	-
Strainer kit	MSF-NP112A1	MSF-NP63A1	-	-	-

(\*1) This function is utilized to prevent cold discharged air at start-up of heating operation, after defrosting operation, etc.  
 (\*2) Advanced wired remote controller PC-ARF1 needs to be connected.  
 (\*3) Included as standard equipment.  
 (\*4) 7 steps are available by individual louver setting. 5 steps only in the operation of Cooling or Dry.  
 (\*5) 5 steps only in the operation of Cooling or Dry.  
 (\*6) Basic Receiver kit (PC-RLH11) is equipped with the unit in package as standard optional part with Wireless Remote Controller (PC-LH7QE).



# Solutions

Other indoor units



## WALL MOUNTED

(DC) [RPK-FSRM]

- ① Simple installation procedure.
- ② Flexible discreet design suitable for any interior.
- ③ **Hotel Setback** feature available, leading to better operation.
- ④ **GentleCool** control to ensure you are not bothered by cold draft.



## WALL MOUNTED

(DC) [RPK-HNBUSQ]



- ① **Meet your detailed requirement & Display**  
RDC fan motor help realize 6-step fan speed adjustment, more quiet and efficient. Also newly equipped display set-temperature and operation status on front cover by LED.
- ② **Simple installation procedure.**  
Refrigerant piping can be connected from the rear, base, or left of the unit, providing much greater flexibility for piping and selection of installation sites.
- ③ **Flexible design suitable for any décor.**  
With smooth flat covers, the units match most modern interiors. Their compact size enables them to blend in, even in small spaces.  
Compact cabinet design with 203mm depth up to 1.3HP and 230mm depth up to 2.5HP.
- ④ **Easy maintenance.**  
Front flat panel keeps the unit from dust and facilitates maintenance work.  
The front grille hinges open easily—no tools are needed to gain quick access to the filter.  
The filter can be removed and cleaned as required.



# Solutions

Other indoor units



## FLOOR/CEILING CONVERTIBLE

(AC) [RPFC-FSNQ]

### 1 2-in-1 versatile unit.

#### Ceiling-suspended installation.

Supplies air to a wide area. Suitable for higher ceilings.

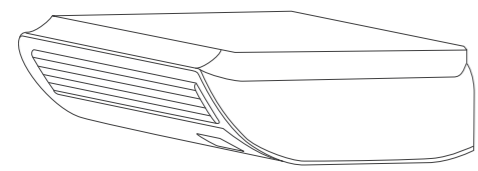

Ceiling Type

#### Floor-mounted installation.

Smaller footprint: only 230mm in depth. Suitable for installation beneath a window thanks to the 680mm height.

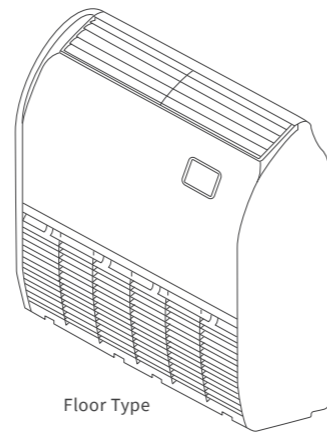

Floor Type

### 2 New air-intake design.

Equipped with air-intakes, the unit can be connected to ventilation equipment such as a Total Heat Exchanger using a duct, providing better interior air quality.

## CEILING SUSPENDED

(DC) [RPC-FSR]



### 1 7m reach motion sensor (option: SOR-NEP).

Use a motion sensor for extra savings when the room is vacant.

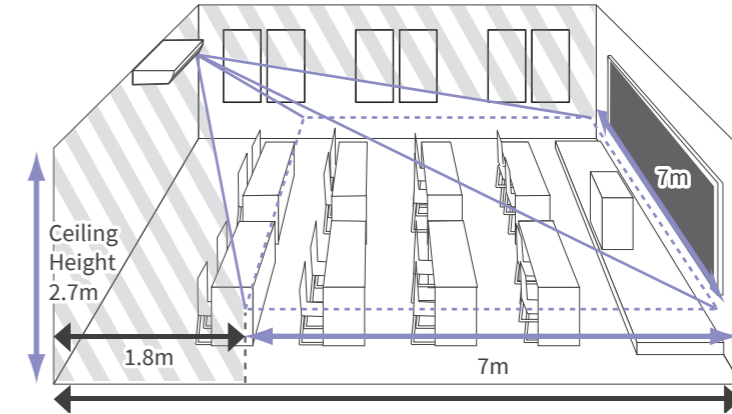

### 2 Auto-swing available.

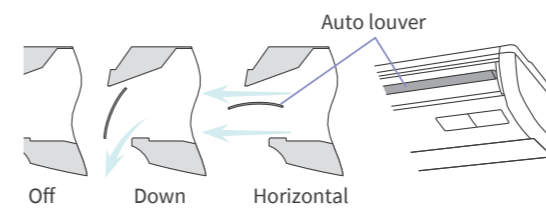

### 3 8m air flow reach.

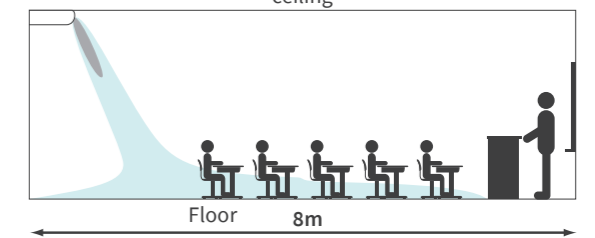

### 4 Decreased sound pressure, thanks to new fan inlet and fan designs.

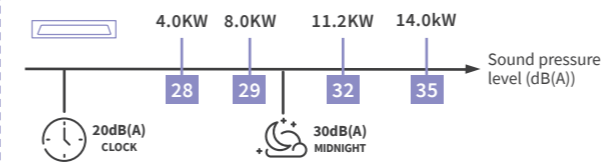

### 5 Suitable for high ceilings.

Capacity model (HP)	1.5-3.0	4.0-6.0
Air flow height (m)	3.5	4.3

\* air flow volume: high

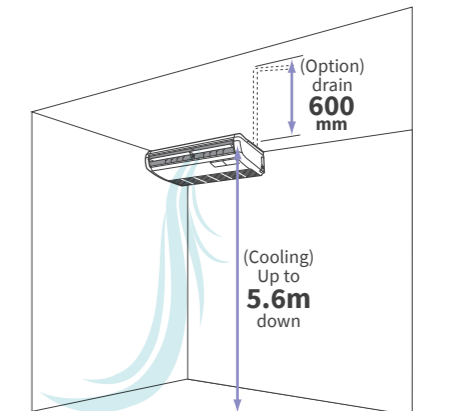

\* Air flow rate: Hi2  
\* 4.0-6.0 FSR



# Solutions

Other indoor units



## FLOOR CONCEALED

(AC) [RPF1-FSNQ]

- 1 Blends unobtrusively with any interior décor: only the suction and discharge grilles are visible.
- 2 Its low height (only 620mm) enables the unit to fit perfectly beneath a window.
- 3 Requires little installation space thanks to its slim 202mm depth.

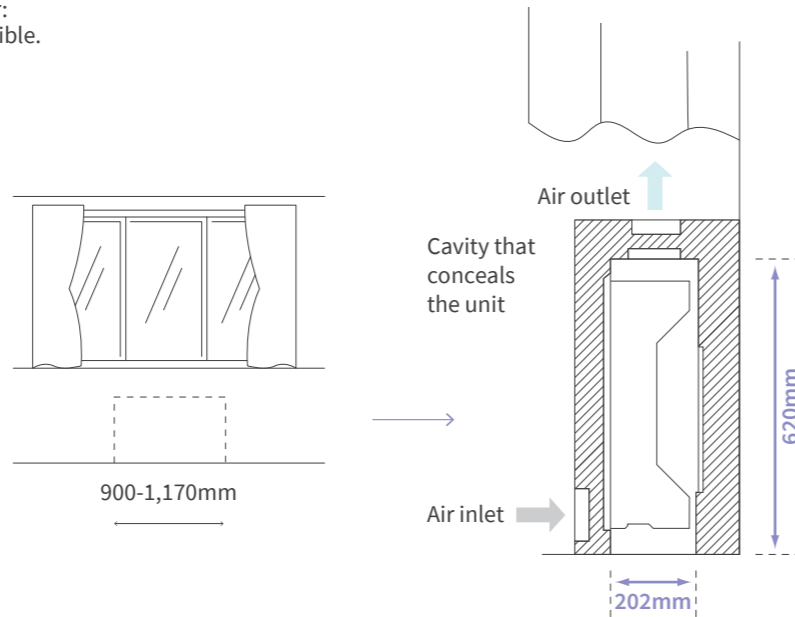

# Specifications & accessories

NEW

## HIGH ESP HIGH EXTERNAL STATIC PRESSURE

(AC) [RPIH-HNAUN1Q, RPI-FSNQ]



Model		RPIH-3.0HNAUN1Q	RPIH-3.3HNAUN1Q	RPIH-4.0HNAUN1Q	RPIH-5.0HNAUN1Q	RPIH-6.0HNAUN1Q	RPI-8.0FSNQ	RPI-10.0FSNQ	
Indoor Unit Power Supply		AC 1Φ, [220-240V/50Hz]						AC 3Φ, [380-415V/50Hz]	
Nominal Capacity	kW	8.4	9.0	11.2	14.2	16.0	22.4	28.0	
Sound Pressure Level	(Hi/Me/Lo) dB(A)	42/39/34	42/39/34	43/39/34	44/41/37	48/42/37	50	52	
Outer Dimension	H×W×D mm	300×1,175×800	300×1,175×800	300×1,175×800	300×1,475×800	300×1,475×800	470×1,060×1,120	470×1,250×1,120	
Net Weight	kg	45	45	45	53	54	96	104	
Refrigerant		R410A	R410A	R410A	R410A	R410A	R410A	R410A	
Indoor Fan Air Flow Rate	(Hi/Me/Lo) m <sup>3</sup> /min	30/28/23	30/28/23	30/28/23	35.5/32/27	41/33/26	58	72	
External Static Pressure (*3)	Pa	120(90)	120(90)	120(90)	120(90)	120(90)	180	180	
Connections		Flare-Nut Connection (with Flare Nuts)						Brazing connection	
Refrigerant Piping	Liquid Line mm	Φ9.52	Φ9.52	Φ9.52	Φ9.52	Φ9.52	Φ9.52	Φ9.52	
Diameter	Gas Line mm	Φ15.88	Φ15.88	Φ15.88	Φ15.88	Φ15.88	Φ19.05	Φ22.23	
Condensate Drain		VP25	VP25	VP25	VP25	VP25	VP25	VP25	
Approximate Packing Volume	m <sup>3</sup>	0.40	0.40	0.40	0.49	0.49	0.90	1.06	

Receiver Kit	Basic	PC-RLH11
	Advanced	PC-ALHZ1
Condensate Drain Pump Kit	PRIH-HNAUN1Q	DUPI-361Q
	PRI-FSNQ	DUPI-15H2Q
Air filter	3.0-4.0 (HP)	KW-PP9Q
	5.0-6.0 (HP)	KW-PP10Q
AQtiv-Ion Kit	PRIH-HNAUN1Q	JK-LZAQ

Notes:

1. The cooling capacity above show the maximum capacities when the outdoor and indoor temperature are under the following conditions.  
Cooling Operation Conditions  
Indoor Air Inlet Temperature:.....27.0°C DB  
19.0°C WB  
Outdoor Air Inlet Temperature:.....35.0°C DB  
Piping Length:7.5 metre  
Piping Lift:0 metre
2. The sound pressure level is based on following conditions. 1.4 metre Beneath the unit. With Discharge Duct (2.0 metre) and Return Duct (1.0 metre). Voltage of the power source for the indoor fan motor is 220V.(In case of the power source of 240V, the sound pressure level increases by about 1-2dB(A).) The above data was measured in an anechoic chamber so that reflected sound should be taken into consideration in the field.
3. The data for external pressure (\*3) indicates "Standard Pressure Setting values when a filter is not used.

NEW

## HIGH ESP HIGH EXTERNAL STATIC PRESSURE

(DC) [RPIH-HNDUSQ]



Model		RPIH-8.0HNDUSQ	RPIH-10.0HNDUSQ
Indoor Unit Power Supply		AC1Φ, [220-240V/50Hz] [220V/60Hz]	
Nominal Cooling	kW	23.2	28.6
Capacity (*1)	kcal/h	20,000	24,600
	Btu/h	79,200	97,600
Nominal Cooling	kW	22.4	28.0
Capacity (*2)	kcal/h	19,300	24,100
	Btu/h	76,500	95,600
Cooling Power Consumption	kW	0.49	0.83
Sound Pressure Level (Overall A Scale) (*4)	dB	49/48/47/46/45/44	53/52/50/49/47/45
Outer Dimensions	H×W×D mm	470×1,250×1,120	470×1,250×1,120
Net Weight	kg	104	104
	(lbs.)	(229)	(229)
Refrigerant		R410A (Nitrogen-Charged for Corrosion-Resistance)	
Indoor Fan Air Flow Rate	m <sup>3</sup> /h	3420/3240/3120/3060/2940/2850	4320/4080/3900/3660/3450/3000
	(cfm)	(2012/1906/1835/1800/1730/1677)	(2541/2400/2294/2153/2030/1765)
External Pressure (*3)	Pa	150	150
Connections		Brazing connection	
Refrigerant Piping	Liquid Line mm	Φ9.53	Φ9.53
	Gas Line (*5) mm	Φ22.2	Φ22.2
Condensate Drain		VP25	VP25
Approximate Packing Measurement	m <sup>3</sup>	1.08	1.08

Receiver Kit	Basic	PC-RLH11	Air filter	Normal Filter	KW-PP14Q
	Advanced	PC-ALHZ1		Coarse Filter	F-10LPIE
Condensate Drain Pump Kit		DUPI-810AQ	ePM10 Filter	F-10HPIE	
			Filter Box	FB-10PIE	
AQtiv-Ion Kit				JK-LZAQ	

Notes:

1. The nominal cooling capacity is the combined capacity of the standard split system.  
Cooling Operation Conditions  
Indoor Air Inlet Temperature:.....27.0°C DB  
(\*1) 19.5°C WB  
(\*2) 19.0°C WB  
Outdoor Air Inlet Temperature:.....35.0°C DB  
Piping Length:7.5 metre  
Piping Lift:0 metre
2. The sound pressure level is based on following conditions. With Discharge Duct (2.0m) and Return Duct (1.0m). Voltage of the power source for the indoor fan motor is 220V. In case of the power source of 240V, the sound pressure level increases by about 1dB. The above data was measured in an anechoic chamber so that reflected sound should be taken into consideration in the field.
3. The data for external pressure (\*3) indicates "Standard Pressure Setting values when a filter is not used.
- 4.(\*4) The noise value is 150Pa corresponding value.
- 5.(\*5) The size of 8HP gas pipe is Φ22.2mm when leaving the factory, and the diameter can be changed to 19.05mm after welding the adapter pipe.

# Specifications & accessories



NEW

## MEDIUM ESP MEDIUM EXTERNAL STATIC PRESSURE (AC) [RPIM-HNAUN1Q, RPI-FSN3Q]

Model		RPIM-0.8HNAUN1Q	RPIM-1.0HNAUN1Q	RPIM-1.3HNAUN1Q	RPIM-1.5HNAUN1Q	RPIM-1.8HNAUN1Q	RPIM-2.0HNAUN1Q	RPIM-2.3HNAUN1Q	RPIM-2.5HNAUN1Q	RPI-8.0FSN3Q	RPI-10.0FSN3Q	
Indoor Unit Power Supply		AC 1Φ, [220-240V/50Hz]									AC 3Φ, [380-415V/50Hz]	
Nominal Capacity	kW	2.2	2.8	3.6	4.3	5.0	5.6	6.3	7.1	22.4	28.0	
Sound Pressure Level	(Hi/Me/Lo) dB(A)	32/27/24	32/27/24	35/33/28	35/33/28	35.5/33/28	35.5/33/28	39/34/26	39/34/26	50	52	
Outer Dimension	(H×W×D) mm	270×725×720	270×725×720	270×725×720	270×725×720	270×975×720	270×975×720	270×975×720	270×975×720	470×1,060×1,120	470×1,250×1,120	
Net Weight	kg	24	24	25	25	31	31	32	32	96	104	
Refrigerant		R410A	R410A	R410A	R410A	R410A	R410A	R410A	R410A	R410A	R410A	
Indoor Fan Air Flow Rate	(Hi/Me/Lo) m <sup>3</sup> /min	10/8/7	10/8/7	12/11/9	12/11/9	16/14/11.5	16/14/11.5	20/16/11	20/16/11	58(56*)	72(70*)	
External Static Pressure (*3)	Pa	50(80)	50(80)	50(80)	50(80)	50(80)	50(80)	50(80)	50(80)	100	100	
Connections		Flare-Nut Connection (with Flare Nuts)									Brazing connection	
Refrigerant Piping Diameter	Liquid Line Gas Line mm	Φ6.35 Φ12.7	Φ6.35 Φ12.7	Φ6.35 Φ12.7	Φ6.35 Φ12.7	Φ6.35 Φ15.88	Φ6.35 Φ15.88	Φ9.52 Φ15.88	Φ9.52 Φ15.88	Φ9.52 Φ19.05	Φ9.52 Φ22.23	
Condensate Drain		VP25	VP25	VP25	VP25	VP25	VP25	VP25	VP25	VP25	VP25	
Approximate Packing Volume	m <sup>3</sup>	0.22	0.22	0.22	0.22	0.28	0.28	0.28	0.28	0.90	1.06	

Receiver Kit	Basic	PC-RLH11
	Advanced	PC-ALHZ1
Condensate Drain Pump Kit	0.8-2.5 (HP)	DUPI-131Q
	8.0-10.0 (HP)	DUPI-15H2Q
Air filter	0.8-1.5 (HP)	KW-PP7Q
	1.8-2.5 (HP)	KW-PP8Q
AQtiv-Ion Kit	PRIM-HNAUN1Q	JK-LZAQ

Notes:  
 1. The cooling capacity above show the maximum capacities when the outdoor and indoor temperature are under the following conditions.  
 Cooling Operation Conditions  
 Indoor Air Inlet Temperature:.....27.0°C DB  
 19.0°C WB  
 Outdoor Air Inlet Temperature:.....35.0°C DB  
 Piping Length:7.5 metre  
 Piping Lift:0 metre  
 2. The sound pressure level is based on following conditions. 1.4 metre Beneath the unit. With Discharge Duct (2.0 metre) and Return Duct (1.0 metre). Voltage of the power source for the indoor fan motor is 220V. (In case of the power source of 240V, the sound pressure level increases by about 1~2dB(A).) The above data was measured in an anechoic chamber so that reflected sound should be taken into consideration in the field.  
 3. The data for external pressure (\*3) indicates "Standard Pressure Setting values when a filter is not used."

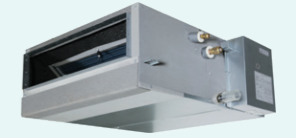

NEW

## LOW ESP LOW EXTERNAL STATIC PRESSURE (AC) [RPIL-HNAUN1Q]

Model		RPIL-0.8HNAUN1Q	RPIL-1.0HNAUN1Q	RPIL-1.3HNAUN1Q	RPIL-1.5HNAUN1Q	RPIL-1.8HNAUN1Q	RPIL-2.0HNAUN1Q	RPIL-2.3HNAUN1Q
Indoor Unit Power Supply		AC 1Φ, [220-240V/50Hz]						
Nominal Capacity	kW	2.2	2.8	3.6	4.3	5.0	5.6	6.3
Sound Pressure Level	(Hi/Me/Lo) dB(A)	28/25/22	28/25/22	34/32/30	34/32/30	34/32/29	34/32/29	36.5/30.5/25
Outer Dimension	(H×W×D) mm	270×725×720	270×725×720	270×725×720	270×725×720	270×975×720	270×975×720	270×975×720
Net Weight	kg	24	24	25	25	31	31	32
Refrigerant		R410A	R410A	R410A	R410A	R410A	R410A	R410A
Indoor Fan Air Flow Rate	(Hi/Me/Lo) m <sup>3</sup> /min	9/8/7	9/8/7	13/11/9	13/11/9	15/14/12	15/14/12	21/14/11
External Static Pressure (*3)	Pa	30	30	30	30	30	30	30
Connections		Flare-Nut Connection (with Flare Nuts)						
Refrigerant Piping Diameter	Liquid Line Gas Line mm	Φ6.35 Φ12.7	Φ6.35 Φ12.7	Φ6.35 Φ12.7	Φ6.35 Φ12.7	Φ6.35 Φ15.88	Φ6.35 Φ15.88	Φ9.52 Φ15.88
Condensate Drain		VP25	VP25	VP25	VP25	VP25	VP25	VP25
Approximate Packing Volume	m <sup>3</sup>	0.22	0.22	0.22	0.22	0.28	0.28	0.28

Model		RPIL-2.5HNAUN1Q	RPIL-3.0HNAUN1Q	RPIL-3.3HNAUN1Q	RPIL-4.0HNAUN1Q	RPIL-5.0HNAUN1Q	RPIL-6.0HNAUN1Q
Indoor Unit Power Supply		AC 1Φ, [220-240V/50Hz]					
Nominal Capacity	kW	7.1	8.4	9.0	11.2	14.2	16.0
Sound Pressure Level	(Hi/Me/Lo) dB(A)	36.5/30.5/25	38/30/24	38/30/24	38/35/31	44/39/35	46/41/35
Outer Dimension	(H×W×D) mm	270×975×720	300×1,175×800	300×1,175×800	300×1,175×800	300×1,475×800	300×1,475×800
Net Weight	kg	32	45	45	45	53	54
Refrigerant		R410A	R410A	R410A	R410A	R410A	R410A
Indoor Fan Air Flow Rate	(Hi/Me/Lo) m <sup>3</sup> /min	21/14/11	29/25/21	29/25/21	29/25/21	36/31/26	42/34/26
External Static Pressure (*3)	Pa	30	60	60	60	60	60
Connections		Flare-Nut Connection (with Flare Nuts)					
Refrigerant Piping Diameter	Liquid Line Gas Line mm	Φ9.52 Φ15.88	Φ9.52 Φ15.88	Φ9.52 Φ15.88	Φ9.52 Φ15.88	Φ9.52 Φ15.88	Φ9.52 Φ15.88
Condensate Drain		VP25	VP25	VP25	VP25	VP25	VP25
Approximate Packing Volume	m <sup>3</sup>	0.28	0.40	0.40	0.40	0.49	0.49

Receiver Kit	Basic	PC-RLH11
	Advanced	PC-ALHZ1
Condensate Drain Pump Kit	0.8-2.5 (HP)	DUPI-131Q
	3.0-6.0 (HP)	DUPI-361Q

Air filter	0.8-1.5 (HP)	KW-PP7Q
	1.8-2.5 (HP)	KW-PP8Q
	3.0-4.0 (HP)	KW-PP9Q
	5.0-6.0 (HP)	KW-PP10Q
AQtiv-Ion Kit		JK-LZAQ

Notes:  
 1. The cooling capacity above show the maximum capacities when the outdoor and indoor temperature are under the following conditions.  
 Cooling Operation Conditions  
 Indoor Air Inlet Temperature:.....27.0°C DB  
 19.0°C WB  
 Outdoor Air Inlet Temperature:.....35.0°C DB  
 Piping Length: 7.5 metre  
 Piping Lift: 0 metre  
 2. The sound pressure level is based on following conditions. 1.4 metre Beneath the unit. With Discharge Duct (2.0 metre) and Return Duct (1.0 metre). Voltage of the power source for the indoor fan motor is 220V. (In case of the power source of 240V, the sound pressure level increases by about 1~2dB(A).) The above data was measured in an anechoic chamber so that reflected sound should be taken into consideration in the field.  
 3. The data for external pressure (\*3) indicates "Standard Pressure Setting values when a filter is not used."





# Specifications & accessories

## SILENT-ICONIC™ 4-WAY CASSETTE DESIGN PANEL FOR 4-WAY CASSETTE [RCI-FSRP]



Model	P-GP160NAP	P-GP160NAPU	P-GP160KAP
Standard/option	Design Panel Standard	Design Panel with an Elevation Grille	Design Panel Standard
Color	Natural White	Natural White	Black

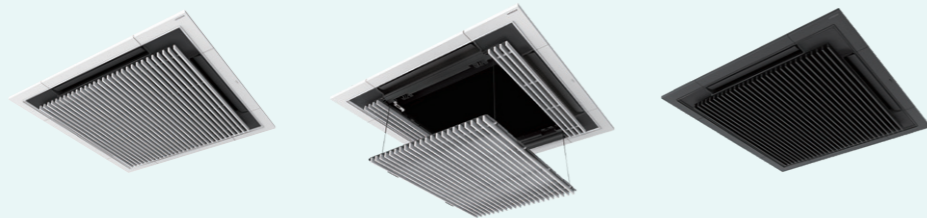

## 4-WAY CASSETTE COMPACT (DC) [RCIM-FSRE]

Model	RCIM-0.6FSRE	RCIM-0.8FSRE	RCIM-1.0FSRE	RCIM-1.5FSRE	RCIM-2.0FSRE	RCIM-2.5FSRE	
Indoor Unit Power Supply	AC 1Φ, [230V/50Hz] [220-240V/50Hz] [220V/60Hz]						
Nominal Capacity	kW	1.6	2.2	2.8	4.0	5.6	7.1
Sound Pressure Level	(Hi2/Hi/Me/Lo) dB(A)	34/30/28/24.5	36/33/29/24.5	38/34/30/24.5	41/37/33/27.5	45/39/35/31	47/43/39/35
Outer Dimension	(H×W×D) mm	285×570×570	285×570×570	285×570×570	285×570×570	285×570×570	285×570×570
Net Weight	kg	16	16	16	16	17	17
Refrigerant		R410A	R410A	R410A	R410A	R410A	R410A
Indoor Fan Air Flow Rate	(Hi2/Hi/Me/Lo) m³/min	10/8.5/7.5/6	11/9.5/8/6	12/10/8.5/6	13/11/9.5/7	15/12/10/8	16/14/12/10
Connections	Flare-Nut Connection (with Flare Nuts)						
Refrigerant Piping	Liquid Line mm	Φ6.35	Φ6.35	Φ6.35	Φ6.35	Φ6.35	Φ9.52
Diameter	Gas Line mm	Φ12.7	Φ12.7	Φ12.7	Φ12.7	Φ12.7	Φ15.88
Condensate Drain		VP25	VP25	VP25	VP25	VP25	VP25
Approximate Packing Volume	m³	0.13	0.13	0.13	0.13	0.13	0.13

Decoration panel	P-AP56NAM	Motion Sensor	SOR-NEC
Decoration panel with Receiver kit	Advanced P-AP56NAMR	Condensate Drain Pump Kit	-(Standard)
Receiver kit	Advanced PC-ALHC1	Duct Adapter	PD-75C

- Notes:
- The cooling capacity above show the maximum capacities when the outdoor and indoor temperature are under the following conditions.  
Cooling Operation Conditions  
Indoor Air Inlet Temperature:.....27.0°C DB  
19.0°C WB  
Outdoor Air Inlet Temperature: .....35.0°C DB  
Piping Length:7.5 metre  
Piping Lift:0 metre
  - The sound pressure level is based on following conditions. 1.5 metre Beneath the unit.  
The data in the table above was measured in an anechoic chamber so that reflected sound should be taken into consideration in the field.
  - RCIM-0.6FSRE cannot be connected to HNRQ series.  
Please refer to the technical catalogue for the details.

## 2-WAY CASSETTE (DC) [RCD-FSR]



Model	RCD-0.8FSR	RCD-1.0FSR	RCD-1.5FSR	RCD-2.0FSR	RCD-2.5FSR	RCD-3.0FSR	RCD-4.0FSR	RCD-5.0FSR	RCD-6.0FSR	
Indoor Unit Power Supply	AC 1Φ, [220-240V/50Hz] [220V/60Hz]									
Nominal Capacity	kW	2.2	2.8	4.0	5.6	7.1	8.0	11.2	14.0	16.0
Sound Pressure Level	(Hi2/Hi/Me/Lo) dB(A)	30/29/28/27	31/29/28/27	37/34/31/30	39/36/33/30	42/39/36/33	45/42/38/33	43/40/37/34	47/44/41/35	48/45/42/39
Outer Dimension	(H×W×D) mm	298×860×630	298×860×630	298×860×630	298×860×630	298×860×630	298×860×630	298×1,420×630	298×1,420×630	298×1,420×630
Net Weight	kg	23	23	25	25	25	25	39	39	39
Refrigerant		R410A	R410A	R410A	R410A	R410A	R410A	R410A	R410A	R410A
Indoor Fan Air Flow Rate	(Hi2/Hi/Me/Lo) m³/min	10/9/7.5/6.5	11/9.5/8.5/7	15/13/11.5/10	16.5/14.5/12.5/10.5	18.5/16.5/14.5/12.5	21/18.5/16/12.5	30/26.5/23/20	35/31/27/21	37/32.5/28.5/24
Connections	Flare-Nut Connection (with Flare Nuts)									
Refrigerant Piping	Liquid Line mm	Φ6.35	Φ6.35	Φ6.35	Φ6.35	Φ9.52	Φ9.52	Φ9.52	Φ9.52	Φ9.52
Diameter	Gas Line mm	Φ12.7	Φ12.7	Φ12.7	Φ12.7	Φ15.88	Φ15.88	Φ15.88	Φ15.88	Φ15.88
Condensate Drain		VP25	VP25	VP25	VP25	VP25	VP25	VP25	VP25	VP25
Approximate Packing Volume	m³	0.24	0.24	0.24	0.24	0.24	0.24	0.36	0.36	0.36

Decoration panel	0.8-3.0 (HP)	P-AP90DNA	0.8-3.0 (HP)	F-90MD-K1
	4.0-6.0 (HP)	P-AP160DNA	4.0-6.0 (HP)	F-160MD-K1
Receiver kit	Advanced	PC-ALHD1	0.8-3.0 (HP)	B-90HD
Motion Sensor		SOR-NED	4.0-6.0 (HP)	B-160HD
Condensate Drain Pump Kit		-(Standard)		-(Standard)
Duct Adapter		PD-150D		
Normal Air Filter			Filter Box	
ViroSense S filter				

- Notes:
- The cooling capacity above show the maximum capacities when the outdoor and indoor temperature are under the following conditions.  
Cooling Operation Conditions  
Indoor Air Inlet Temperature:.....27.0°C DB  
19.0°C WB  
Outdoor Air Inlet Temperature: .....35.0°C DB  
Piping Length:7.5 metre  
Piping Lift:0 metre
  - The sound pressure level is based on following conditions. 1.5 metre Beneath the unit.  
The data in the table above was measured in an anechoic chamber so that reflected sound should be taken into consideration in the field.

## 1-WAY CASSETTE (DC) [RCS-FSR]



Model	RCS-0.8FSR	RCS-1.0FSR	RCS-1.5FSR	RCS-2.0FSR	RCS-2.5FSR	RCS-3.0FSR	
Indoor Unit Power Supply	AC 1Φ, [220-240V/50Hz] [230V/50Hz] [220V/60Hz]						
Nominal Capacity	kW	2.2	2.8	4.0	5.6	7.1	8.0
Sound Pressure Level	(Hi2/Hi/Me/Lo) dB(A)	34/32/29/27	36/34/31/28	40/37/33/31	42/38/35/31	43/39/36/32	43/40/37/33
Outer Dimension	(H×W×D) mm	235×900×710	235×900×710	235×900×710	235×900×710	235×1,210×710	235×1,210×710
Net Weight	kg	25	25	26	26	33	33
Refrigerant		R410A	R410A	R410A	R410A	R410A	R410A
Indoor Fan Air Flow Rate	(Hi2/Hi/Me/Lo) m³/min	8.5/7.5/6.5/6	9.5/8.5/7.5/6.5	13/11.5/10/8.5	14.5/13/11/9.5	18.5/16.5/14.5/12.5	20/17.5/15.5/13
Connections	Flare-Nut Connection (with Flare Nuts)						
Refrigerant Piping	Liquid Line mm	Φ6.35	Φ6.35	Φ6.35	Φ6.35	Φ9.52	Φ9.52
Diameter	Gas Line mm	Φ12.7	Φ12.7	Φ12.7	Φ12.7	Φ15.88	Φ15.88
Condensate Drain		VP25	VP25	VP25	VP25	VP25	VP25
Approximate Packing Volume	m³	0.25	0.25	0.25	0.25	0.32	0.32

Decoration panel	0.8-1.0 (HP)	P-AP36CNA	Duct Adapter	PD-100
	1.5-2.0 (HP)	P-AP56CNA	Grille for Front Discharge	0.8-2.0 (HP) DG-56SW1
	2.5-3.0 (HP)	P-AP80CNA		2.5-3.0 (HP) DG-80SW1
Receiver kit	Advanced	PC-ALHS1		0.8-2.0 (HP) PIS-56LS
Motion Sensor		SOR-NES	Air Outlet Shutter Plate	2.5-3.0 (HP) PIS-80LS
Condensate Drain Pump Kit		-(Standard)	ViroSense S filter	-(Standard)

- Notes:
- The cooling capacity above show the maximum capacities when the outdoor and indoor temperature are under the following conditions.  
Cooling Operation Conditions  
Indoor Air Inlet Temperature:.....27.0°C DB  
19.0°C WB  
Outdoor Air Inlet Temperature: .....35.0°C DB  
Piping Length:7.5 metre  
Piping Lift:0 metre
  - The sound pressure level is based on following conditions. 1.5 metre Beneath the unit.  
The data in the table above was measured in an anechoic chamber so that reflected sound should be taken into consideration in the field.

# Specifications & accessories



## WALL MOUNTED (DC) [RPK-FSRM]

Type	Expansion Valve built-in type		
Model	RPK-2.5FSRM	RPK-3.0FSRM	RPK-4.0FSRM
Indoor Unit Power Supply	AC 1Φ, [220-240V/50Hz] [220V/60Hz]		
Nominal Capacity	kW 7.1	8.0	11.2
Sound Pressure Level	(Hi2/Hi/Me/Lo) dB(A) 45/42/38/35	47/44/40/35	51/48/44/39
Color	White		
Outer Dimension	(H×W×D) mm 300×1,100×260	300×1,100×260	300×1,100×260
Net Weight	kg 15	15	15
Refrigerant	R410A	R410A	R410A
Indoor Fan Air Flow Rate	(Hi2/Hi/Me/Lo) m <sup>3</sup> /min 18.5/16.5/14/12	20/17.5/15.5/12.5	23/20/17.5/14.5
Motor	38	38	38
Connections	Flare-Nut Connection (with Flare Nuts)		
Refrigerant Piping Diameter	Liquid Line mm Φ9.52 Gas Line mm Φ15.88	Φ9.52 Φ15.88	Φ9.52 Φ15.88
Condensate Drain	VP16	VP16	VP16
Approximate Packing Volume	m <sup>3</sup> 0.14	0.14	0.14
Accessory included	Wall Mounting Bracket		

Receiver kit	Advanced	PC-ALHZ1
Strainer kit		MSF-NP112A1

### Notes:

1. The cooling capacity above show the maximum capacities when the outdoor and indoor temperature are under the following conditions.

Cooling Operation Conditions  
Indoor Air Inlet Temperature:.....27.0°C DB  
19.0°C WB

Outdoor Air Inlet Temperature:.....35.0°C DB  
Piping Length: 7.5 metre  
Piping Lift: 0 metre

2. The sound pressure level is based on following conditions.  
1.0 metre Beneath the Unit.  
1.0 metre from Discharge Grille.

The above data was measured in an anechoic chamber so that reflected sound should be taken into consideration in the field.  
When bottom air inlet is adopted, sound pressure will increase according to factors such as installation mode and the room structure.

## Strainer kit

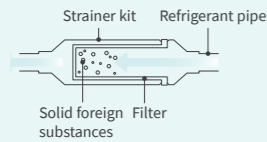

A strainer kit ensures that solid foreign substances, like small particles of metal, are caught before they enter the electric expansion valves of a wall-mounted indoor unit. Without the strainer kit's filter, these particles may prevent the valves from being fully sealed, creating a risk of explosive condensation when the unit becomes active.

## WALL MOUNTED (DC) [RPK-HNBUSQ]



Model	RPK-0.8HNBUSQ	RPK-1.0HNBUSQ	RPK-1.3HNBUSQ	RPK-1.5HNBUSQ	RPK-1.8HNBUSQ	RPK-2.0HNBUSQ	RPK-2.3HNBUSQ	RPK-2.5HNBUSQ
Indoor Unit Power Supply	AC 1Φ, 220~240V/50Hz, 220V/60Hz							
Nominal Capacity	kW 2.2	2.8	3.6	4.0	5.0	5.6	6.3	7.1
Sound Pressure Level	(Hi/Me/Lo) dB(A) 36/35/33/32/30/28	36/35/33/32/30/28	38/35/33/32/30/28	38/37/36/32/31/29	44/42/41/38/31/29	40/38/36/35/33/31	41/40/38/35/33/31	45/42/41/38/35/31
Color	White							
Outer Dimension	(H×W×D) mm 270×815×203	270×815×203	270×815×203	315×915×230	315×915×230	315×1085×230	315×1085×230	315×1085×230
Net Weight	kg 9.0	9.0	9.0	12.5	12.5	14.0	14.0	14.0
Refrigerant	R410A	R410A	R410A	R410A	R410A	R410A	R410A	R410A
Indoor Fan Air Flow Rate	(Hi/Me/Lo) m <sup>3</sup> /min 9.8/9.2/8.7/8.2/7.5/7.0	9.8/9.2/8.7/8.2/7.5/7.0	10.3/9.2/8.7/8.2/7.5/7.0	11.5/11.0/10.3/9.0/8.7/8.0	14.3/13.5/12.8/11.5/9.0/8.0	16.2/15.0/14.2/13.3/12.2/11.5	17.0/16.2/15.0/13.3/12.2/11.5	20.0/18.0/17.0/15.0/13.3/11.7
Connections	Flare-Nut Connection (with Flare Nuts)							
Refrigerant Piping Diameter	Liquid Line mm Φ6.35 Gas Line mm Φ9.53	Φ6.35 Φ9.53	Φ6.35 Φ9.53	Φ6.35 Φ12.7	Φ6.35 Φ12.7	Φ9.53 Φ15.88	Φ9.53 Φ15.88	Φ9.53 Φ15.88
Condensate Drain	VP16	VP16	VP16	VP16	VP16	VP16	VP16	VP16
Approximate Packing Volume	m <sup>3</sup> 0.11	0.11	0.11	0.15	0.15	0.17	0.17	0.17

Receiver kit	Basic	PC-RLH11
	Advanced	PC-ALHZ1
Strainer kit		MSF-NP63A1

### Notes:

1. The cooling capacity above show the maximum capacities when the outdoor and indoor temperature are under the following conditions.

Cooling Operation Conditions  
Indoor Air Inlet Temperature:.....27.0°C DB (80.0°F DB)  
19.0°C WB (66.2°F WB)

Outdoor Air Inlet Temperature:.....35.0°C DB (95.0°F DB)  
Piping Length:7.5 metre  
Piping Lift:0 metre

2. The sound pressure level is based on following conditions.  
1.0 metre Beneath the unit.  
1.0 metre from Discharge grille.

The above data was measured in an anechoic chamber so that reflected sound should be taken into consideration in the field.  
When bottom air inlet is adopted, sound pressure will increase according to factors such as installation mode and the room structure.

## FLOOR/CEILING CONVERTIBLE (AC) [RPFC-FSNQ]



Model	RPFC-1.8FSNQ	RPFC-2.0FSNQ	RPFC-2.3FSNQ	RPFC-2.5FSNQ	RPFC-3.0FSNQ	RPFC-3.3FSNQ	RPFC-4.0FSNQ	RPFC-5.0FSNQ
Indoor Unit Power Supply	AC 1Φ, [220-240V/50Hz] [220V/60Hz]							
Nominal Capacity	kW 5.0	5.6	6.3	7.1	8.4	9.0	11.2	14.2
Sound Pressure Level	Ceiling Mode dB(A) 39/35/30	39/35/30	45/41/37	45/41/37	43/39/34	45/40/36	51/46/40	50/46/42
	Floor Mode dB(A) 43/38/35	43/38/35	48/44/40	48/44/40	46/41/37	48/43/39	54/49/43	55/50/46
Outer Dimension	(H×W×D) mm 230×990×680	230×990×680	230×990×680	230×990×680	230×1,285×680	230×1,285×680	230×1,285×680	230×1,580×680
Net Weight	kg 31	31	32	32	39	40	41	47
Refrigerant	R410A	R410A	R410A	R410A	R410A	R410A	R410A	R410A
Indoor Fan Air Flow Rate	(Hi/Me/Lo) m <sup>3</sup> /h 780/660/540	780/660/540	966/840/678	966/840/678	1,092/912/732	1,164/978/798	1,488/1,230/978	1,980/1,680/1,380
Connections	Flare-Nut Connection (with Flare Nuts)							
Refrigerant Piping Diameter	Liquid Line mm Φ6.35 Gas Line mm Φ15.88	Φ6.35 Φ15.88	Φ9.52 Φ15.88	Φ9.52 Φ15.88	Φ9.52 Φ15.88	Φ9.52 Φ15.88	Φ9.52 Φ15.88	Φ9.52 Φ15.88
Condensate Drain	VP25	VP25	VP25	VP25	VP25	VP25	VP25	VP25
Approximate Packing Volume	m <sup>3</sup> 0.31	0.31	0.31	0.31	0.40	0.40	0.40	0.48

Receiver kit	Basic	PC-RLH11
	Advanced	PC-ALHZ1

### Notes:

1. The cooling capacity above show the maximum capacities when the outdoor and indoor temperature are under the following conditions.

Cooling Operation Conditions  
Indoor Air Inlet Temperature:.....27.0°C DB  
19.0°C WB

Outdoor Air Inlet Temperature:.....35.0°C DB  
Piping Length: 7.5 metre  
Piping Lift: 0 metre

2. The sound pressure level is based on following conditions.  
1.0 metre Beneath the unit.  
1.0 metre from Discharge grille.

The above data was measured in an anechoic chamber so that reflected sound should be taken into consideration in the field.  
When bottom air inlet is adopted, sound pressure will increase according to factors such as installation mode and the room structure.

# Specifications & accessories



## CEILING SUSPENDED (DC) [RPC-FSR]

Model		RPC-1.5FSR	RPC-2.0FSR	RPC-2.5FSR	RPC-3.0FSR	RPC-4.0FSR	RPC-5.0FSR	RPC-6.0FSR
Indoor Unit Power Supply		AC 1Φ, [220-240V/50Hz] [220V/60Hz]						
Nominal Capacity	kW	4.0	5.6	7.1	8.0	11.2	14.0	16.0
Sound Pressure Level	(Hi2/Hi/Me/Lo) dB(A)	37/35/31/28	38/35/31/28	38/35/31/28	40/37/33/29	44/42/37/32	48/45/41/35	49/47/42/36
Color		Neutral White						
Outer Dimension	(H×W×D) mm	235×960×690	235×960×690	235×1,270×690	235×1,270×690	235×1,580×690	235×1,580×690	235×1,580×690
Net Weight	kg	26	27	35	35	41	41	41
Refrigerant		R410A	R410A	R410A	R410A	R410A	R410A	R410A
Indoor Fan Air Flow Rate	(Hi2/Hi/Me/Lo) m <sup>3</sup> /min	15/13/11/9	15/13/11/9	19/16.5/14/11.5	21/18.5/15.5/12.5	30/26.5/22/17	35/31/25.5/20	37/32.5/27/21
Connections		Flare-Nut Connection (with Flare Nuts)						
Refrigerant Piping	Liquid Line mm	Φ6.35	Φ6.35	Φ9.52	Φ9.52	Φ9.52	Φ9.52	Φ9.52
Diameter	Gas Line mm	Φ12.7	Φ15.88	Φ15.88	Φ15.88	Φ15.88	Φ15.88	Φ15.88
Condensate Drain		VP20	VP20	VP20	VP20	VP20	VP20	VP20
Approximate Packing Volume	m <sup>3</sup>	0.23	0.23	0.31	0.31	0.38	0.38	0.38
Receiver kit	Advanced	PC-ALHP1						
Motion Sensor		SOR-NEP						
Condensate Drain Pump Kit	1.5 (HP)	DUPC-63K1						
	2.0 (HP)	DUPC-71K1						
	2.5-6.0 (HP)	DUPC-160K1						
ViroSense S filter		-(Standard)						

### Notes:

1. The cooling capacity above show the maximum capacities when the outdoor and indoor temperature are under the following conditions.

Cooling Operation Conditions  
 Indoor Air Inlet Temperature:.....27.0°C DB  
 19.0°C WB  
 Outdoor Air Inlet Temperature: .....35.0°C DB  
 Piping Length: 7.5 metre  
 Piping Lift: 0 metre

2. The sound pressure level is based on following conditions.  
 1.0 metre Beneath the unit.  
 1.0 metre from Discharge grille.

The above data was measured in an anechoic chamber so that reflected sound should be taken into consideration in the field.  
 When bottom air inlet is adopted, sound pressure will increase according to factors such as installation mode and the room structure.

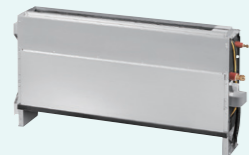

## FLOOR CONCEALED (AC) [RPFI-FSNQ]

Model		RPFI-1.0FSNQ	RPFI-1.5FSNQ	RPFI-2.0FSNQ	RPFI-2.5FSNQ
Indoor Unit Power Supply		AC 1Φ, [220-240V/50Hz]			
Nominal Capacity	kW	2.8	4.3	5.6	7.1
Sound Pressure Level	(Hi/Me/Lo) dB(A)	37/34/31	40/38/35	42/38/36	45/43/40
Outer Dimension	(H×W×D) mm	620×900×202	620×900×202	620×1,170×202	620×1,170×202
Net Weight	kg	25	26	34	34
Refrigerant		R410A	R410A	R410A	R410A
Indoor Fan Air Flow Rate	(Hi/Me/Lo) m <sup>3</sup> /min	8.5/7/6	12/8/7	16/12.5/10.5	16/14/11
Connections		Flare-Nut Connection (with Flare Nuts)			
Refrigerant Piping	Liquid Line mm	Φ6.35	Φ6.35	Φ6.35	Φ9.52
Diameter	Gas Line mm	Φ12.70	Φ12.70	Φ15.88	Φ15.88
Condensate Drain		VP25	VP25	VP25	VP25
Packaging Volume	m <sup>3</sup>	0.19	0.19	0.23	0.23
Receiver kit	Basic	PC-RLH11			
	Advanced	PC-ALHZ1			

### Notes:

1. The cooling capacity above show the maximum capacities when the outdoor and indoor temperature are under the following conditions.

Cooling Operation Conditions  
 Indoor Air Inlet Temperature:.....27.0°C DB  
 19.0°C WB  
 Outdoor Air Inlet Temperature: .....35.0°C DB  
 Piping Length: 7.5 metre  
 Piping Lift: 0 metre

2. The sound pressure level is based on following conditions.  
 1.0 metre from the unit.  
 1.0 metre from floor level.

Voltage of the power source for the indoor fan motor is 220V.  
 The above data was measured in an anechoic chamber.







## Improve indoor air quality!

Today, the average person spends more than 75% of their day indoors. Without proper ventilation, CO<sub>2</sub> levels rise, pollutants circulate and potentially harmful bacteria build-up, impacting on the wellbeing, comfort and productivity of occupants. Make these spaces as healthy and comfortable as possible by connecting our ventilation solutions into your Hitachi VRF systems.

# VENTILATION

---

97 Our ventilation line-up

---

99 Ventilation Solutions

99 All fresh air unit  
100 Total heat exchanger

---

101 DX-KIT

---



# Our ventilation line-up

Our line-up fulfils the ventilation requirements of the desired space by drawing in clean air from the outside and replenishing indoor spaces. It features solutions that suit every type of building; you can use the ventilation technology as it is or it can be incorporated into a Hitachi indoor unit via the fresh-air port. Thanks to our ventilation options, you can optimize the design of your system to meet your needs.

## ALL FRESH AIR UNIT



- Creates a comfortable and healthy indoor environment, thanks to the fresh air and cool functions.
- Various controllers can be selected and interfaced with the H-LINK system.
- Longer ducts can be connected on-site, thanks to the higher ESP.

## TOTAL HEAT EXCHANGER

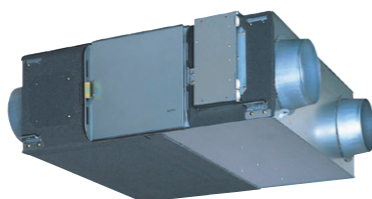

- Creates a healthy indoor environment thanks to the fresh air and ventilation functions.
- Every unit is equipped with a remote controller for the total heat exchanger as a standard part.

## FROM 150 TO 6,000m<sup>3</sup>/h

Fan Air Flow Rate (m <sup>3</sup> /h)	150	200	210	230	300	400	500	550	650	700	800	1,000	1,080	1,250	1,500	1,680	2,000	2,100	2,500	3,000	4,000	5,000	6,000	
All Fresh Air Unit													•				•		•		•	•	•	•
Total Heat Exchanger	•	•	•	•	•	•	•	•	•	•	•	•	•	•	•	•	•	•	•	•	•	•	•	•

## EXTRA AIR-RENEWAL SOLUTION OFFERINGS

We offer two additional options to meet both occupants' needs and your building's requirements.



### DX-KIT

- Offers great flexibility by enabling you to integrate Hitachi VRF into your building's existing air handling units (AHU).
- Wide capacity range (available up to 96HP AHU).
- Wide configuration options with AHU/Indoor units.

### FRESH-AIR INTAKE PORT



- Optional duct adapter which enables fresh air into the unit so that it can be blown out with conditioned air.
- Connects with the indoor units: 4-way cassette type, 4-way compact cassette type, 2-way cassette type, 1-way cassette type.



# Ventilation solutions



## ALL FRESH AIR UNIT

Model		RPI-5.0KFNQ	RPI-8.0KFNQ	RPI-10.0KFNQ	RPI-12.0KFNQ		
Power Supply		AC 1Φ 220-240V/50Hz	AC 1Φ 220V/60Hz	AC 1Φ 220-240V/50Hz	AC 1Φ 220V/60Hz	AC 1Φ 220-240V/50Hz	AC 3Φ 380-415V/50Hz
Cooling	Capacity	kW	14.0	22.4	28.0	28.0	33.5
	Power	kW	0.30	0.48	0.50	0.58	0.68
	Nominal Current	A	1.4	2.2	2.3	2.65	1.43
Sound Pressure Level (overall a scale)	dB(A)	42	44	47	47	56	56
Dimensions	H×W×D	mm	370×1320×800	486×1270×1069	486×1270×1069	486×1270×1069	486×1270×1069
Net Weight	kg	63	110	110	110	110	110
Refrigerant		R410A	R410A	R410A	R410A	R410A	R410A
Air Flow Rate	m <sup>3</sup> /min	18	28	35	35	50	50
External Pressure	Pa	200	220	220	220	220	220
Piping	Liquid	mm	Φ9.53	Φ9.53	Φ9.53	Φ9.53	Φ12.7
	Gas	mm	Φ15.88	Φ15.88	Φ19.05	Φ19.05	Φ25.4
Condensate Drain		VP25, Outer Diameter: Φ32mm					
Temperature range of fresh air drawn		Cooling: 20.0°C-43.0°C					

Model		RPI-16.0KFNQL	RPI-16.0KFNQH	RPI-20.0KFNQL	RPI-20.0KFNQH	RPI-20.0KFNQLF	RPI-20.0KFNQHF
Power Supply		AC 3Φ 380-415V/50Hz	AC 3Φ 380V/60Hz	AC 3Φ 380-415V/50Hz	AC 3Φ 380V/60Hz	AC 3Φ 380-415V/50Hz	AC 3Φ 380V/60Hz
Connectable Outdoor Unit		RAS-160HNCEL(R)W		RAS-200HNCEL(R)WS, RAS-200HNCEL(R)WP, RAS-200HNCEL(R)WS			
Cooling	Capacity	kW	45.0	56.0	56.0	56.0	56.0
	Power	kW	0.72	1.06	1.22	1.39	1.60
	Nominal Current	A	1.8	2.53	2.22	3.14	3.45
Sound Pressure Level (overall a scale)	dB(A)	58	62	61	65	63	67
Dimensions	H×W×D	mm	635×1950×805	635×1950×805	735×1950×805	735×1950×805	735×1950×805
Net Weight	kg	196	196	222	222	222	222
Refrigerant		R410A	R410A	R410A	R410A	R410A	R410A
Air Flow Rate	m <sup>3</sup> /min	67	67	83	83	100	100
External Pressure	Pa	200	300	200	200	200	200
Piping	Liquid	mm	Φ12.7	Φ12.7	Φ15.88	Φ15.88	Φ15.88
	Gas	mm	Φ25.4	Φ25.4	Φ28.6	Φ28.6	Φ28.6
Condensate Drain		RC1 (Internal Screw)					
Temperature range of fresh air drawn		Cooling: 20.0°C-43.0°C					

### Notes:

- Cooling capacity tested in the following conditions:  
Cooling conditions: 33.0°CDB, 28.0°CWB, pipeline length 7.5 metre, pipe height difference 0 metre.
- Noise test conditions are as follows:  
At a distance of 1.5 metre from the unit surface.  
The above parameters are measured in the anechoic chamber without reflected echo, therefore the impact of the reflected echo must be counted at the scene.
- An air filter with dust removal efficiency of 50% or more needs to be installed at the air inlet.
- When the field duct resistance is small and the fan speed is too high, the unit will appear the phenomena of abnormal shutdown, fault, water spray etc., and the duct pipe should be insulated to prevent generating dew.
- Air processor can only be used for processing fresh air, indoor air conditioning load processing need to use other air conditioners.
- Fresh air processing unit should be connected with Hitachi Top Flow VRF unit.  
When fresh air processing unit and other indoor units air all connected to the same outdoor unit, its equivalent cooling capacity is calculated by the following criteria:  
Type\_5HP class: 21.0kW; 8HP class: 33.3kW; 10HP class: 42.0kW
- Refer to capacity restrains shown on Table below for indoor unit capacity connectable to outdoor unit.

System	All Fresh Air Unit System (Only All Fresh Air Unit)	Mixed System (All Fresh Air Unit and Other Indoor Unit)
Range of Combination Capacity	80 to 100%	i) 80 to 100% and ii) Total Capacity of All Fresh Air: 30%

Mixed system is only available with RPI-5.0/8.0/10.0KFNQ.

RPI-12.0KFNQ or above is only available as one to one All Fresh Air Unit system.

8. When outdoor temperature is below 20.0°C in cooling operation, the system will be automatically converted to ventilation operation.

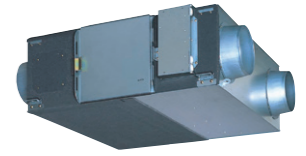

## TOTAL HEAT EXCHANGER

Model		KPI-20H-A-GQ	KPI-30H-A-GQ	KPI-40H-A-GQ	KPI-50H-A-GQ	KPI-65H-A-GQ	KPI-80H-A-GQ	KPI-100H-A-GQ	KPI-125H-A-GQ	
Unit Power Supply		AC 1Φ, [220/50Hz]								
Temp. Efficiency	Summer (Hi/Me/Lo)	%	64/64/70	60/60/65	61/61/66	60/60/62	65/65/69	65/65/69	65/65/69	65/65/69
	Winter (Hi/Me/Lo)	%	80/80/83	77/77/80	79/79/81	75/75/76	75/75/78	74/74/78	72/72/76	70/70/78
Enthalpy Efficiency	Summer (Hi/Me/Lo)	%	69/69/76	63/63/70	64/64/69	63/63/65	57/57/60	60/60/63	58/58/63	53/53/61
	Winter (Hi/Me/Lo)	%	75/75/78	70/70/75	70/70/75	69/69/71	65/65/70	70/70/72	66/66/69	63/63/72
Sound Pressure Level	(Hi/Me/Lo)	dB(A)	32/30/25	36/34/28	39/37/30	40/38/31	40/38/35	40/38/34	43/42/34	42/40/37
Outer Dimension	(H×W×D)	mm	220×962×735	220×962×735	220×1,112×735	220×1,112×735	388×1,119×884	388×1,119×884	388×1,119×884	430×1,250×1,135
Net Weight	kg	38	40	46	52	61	69	69	95	
Air Flow Rate	(Hi/Me/Lo)	m <sup>3</sup> /h	200/200/150	300/300/210	400/400/230	500/500/400	650/650/550	800/800/650	1,000/1,000/700	1,250/1,250/800
External Static Pressure	(Hi/Me/Lo)	Pa	100/70/40	120/90/50	120/90/50	120/90/50	130/100/90	130/100/90	165/120/60	100/50/30
Power Input	(Hi/Me/Lo)	W	120/110/75	165/155/120	210/200/130	330/310/230	2×(188/173/142)	2×(207/188/165)	2×(250/228/205)	2×(308/266/237)
Current	(Hi/Me/Lo)	A	0.6/0.5/0.4	0.8/0.7/0.6	1.0/1.0/0.7	1.6/1.5/1.1	1.72/1.58/1.31	2.04/1.93/1.73	2.35/2.09/1.92	3.03/2.45/2.18
Connection Duct Diameter	mm	Φ144	Φ144	Φ144	Φ194	Φ242	Φ242	Φ242	320×250 +320×250	
Approximate Packing Volume	m <sup>3</sup>	0.37	0.37	0.43	0.49	0.94	1.15	1.15	1.25	

Model		KPI-150H-E-GQ	KPI-200H-E-GQ	KPI-250H-E-GQ	KPI-300H-E-GQ	KPF-400H-E-GQ	KPF-500H-E-GQ	
Unit Power Supply		AC 3Φ, [380/50Hz]						
Temp. Efficiency	Summer	%	63	63	63	63	63	
	Winter	%	68	72	75	75	73	
Enthalpy Efficiency	Summer	%	57	57	55	56	53	
	Winter	%	68	68	72	72	61	
Sound Pressure Level	dB(A)	50	51	53	54	57	58	
Outer Dimension	(H×W×D)	mm	536×1,500×1,300	536×1,500×1,400	640×1,700×1,500	640×1,750×1,600	1,655×1,400×850	1,730×1,700×850
Net Weight	kg	144	155	180	220	225	260	
Air Flow Rate	m <sup>3</sup> /h	1,500	2,000	2,500	3,000	4,000	5,000	
External Static Pressure	Pa	165	160	180	200	220	240	
Power Input	W	2×440	2×810	2×925	2×1080	2×1,470	2×1,980	
Current	A	2.84	3.08	4.19	5.23	5.57	7.51	
Connection Duct Diameter	mm	400×320 +400×320	400×320 +400×320	500×350 +500×350	500×350 +500×350	400×320 +590×320	500×350 +700×320	
Approximate Packing Volume	m <sup>3</sup>	1.82	1.95	2.63	2.93	3.01	3.75	

### Note:

Please confirm the model name for "wires remote controller" compatible with Total Heat Exchanger to your local distributor.



# DX-KIT

Integrate Hitachi VRF into your pre-existing Air Handling Units (AHU).



## DX-KIT: GREAT FLEXIBILITY FOR SIMPLIFIED HVAC UPGRADE

### ① Wide range of capacity:

- (DX-Kit) Single capacity from 2HP to 30HP
- (Custom AHU) up to 112HP available by DX-Kit combination

Our DX-Kit can cover from small to large capacity AHU. It can meet any requirement in any application!

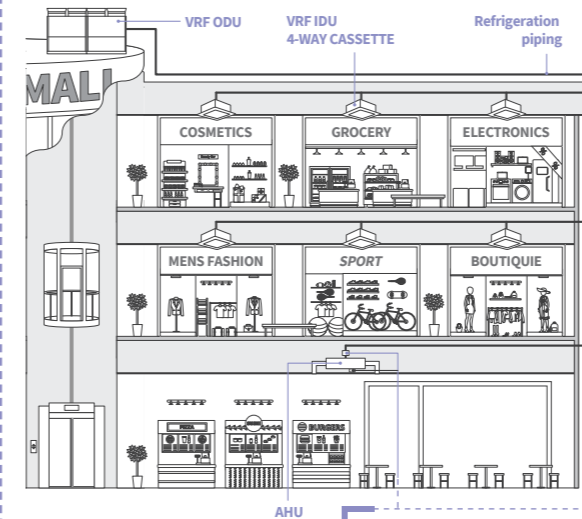

DX-Kit  
Above : Expansion Valve Box (EXV Box).  
Below : Control Box (C Box).

### ② Flexible installation:

- Both outdoor & indoor installation of DX-Kit available
- Design Flexibility in wiring & piping

DX-Kit facilitates system design!

Both outdoor & indoor installations available!

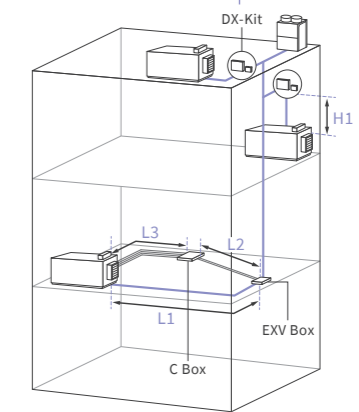

Item	Max (m)
Level difference between AHU Heat Exchanger and EXV Box	H1 2
Piping length between AHU Heat Exchanger and EXV Box	L1 5
Length of control wiring between AHU Heat Exchanger and EXV Box	L2 10
Length of the thermistor to AHU Heat Exchanger from C Box	L3 10

### Dimensions

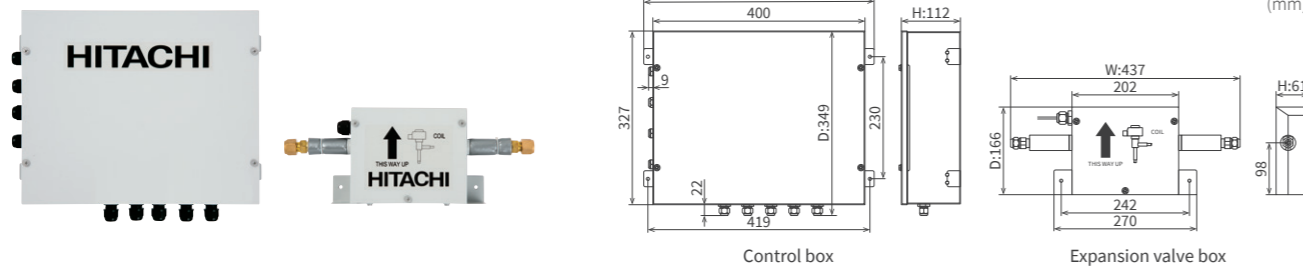

Capacity (HP)	2	4	6	8/10	12~20	22~30
Model	DXF-2.0A1	DXF-4.0A1	DXF-6.0A1	DXF-10.0A1	DXF-20.0A1	DXF-30.0A1
Power Supply	AC1Φ, [220-240V /50Hz] [220V 60Hz]					
Control Box (C Box)	Height	112	112	112	112	112
	Width	435	435	435	435	435
	Depth	349	349	349	349	349
	Weight	5.2	5.2	5.2	5.2	5.2
	Material	Steel Plate + White Grey Coating				
Expansion Valve Box (EXV Box)	Height	61	61	61	61	61
	Width	437	437	437	437	437
	Depth	166	166	166	166	166
	Weight	1.7	1.7	1.7	1.7	1.7
	Quantity	1	1	1	1	2
Material	Steel Plate + White Grey Coating					
Liquid Pipe Diameter	φ6.35	φ9.52	φ9.52	φ9.52	φ12.7	φ12.7

AHU Suction Temperature Range 21.0°C to 32.0°C (DB) / 15.0°C to 23.0°C (WB)

Connection Ratio in different configurations  
 → Total AHU or AHU & IDU Connection Ratio against ODU capacity = X  
 (In case of "Inlet Air Temperature Control")

- 1 ODU to 1 AHU : 50% < X ≤ 100%
- 1 ODU to 1 AHU (Separate Heat Exchanger Type) : 50% < X ≤ 100%
- 1 ODU to Multiple AHUs : 50% < X ≤ 100%
- 1 ODU to AHU & IDUs :
  - (1) 50% < X ≤ 100% → Total AHU capacity: No limitation / Each AHU capacity: No limitation
  - (2) 100% < X ≤ 110% → Total AHU capacity: less than 30% of total capacity / Each AHU capacity: between 2-6HP class

Maximum Piping Length	Total	m	2	4	6	8/10	12~20	22~30
Between AHU Heat Exchanger and EXV Box		m	5	5	5	5	5	5
Between ODU and [AHU/IDU]		m	• 50 (When ODU is above [AHU & IDU & DX-Kit].) • 40 (When ODU is below [AHU & IDU & DX-Kit].)					
Maximum Level Difference		m	2	2	2	2	2	2
Maximum Length	Control wiring between AHU Heat Exchanger and EXV Box	m	10	10	10	10	10	10
	Thermistor to AHU Heat Exchanger from C Box	m	10	10	10	10	10	10

Temperature Control Modes (\*1)  
 • Inlet Air Temperature Control  
 • Outlet Air Temperature Control  
 • Duty Control

(\*1) [Outlet Air Temperature Control] & [Duty Control] are available only in case of connections "1 ODU to 1 AHU" & "1 ODU to 1 AHU (Separate Heat Exchanger Type)".

### ③ 4 examples of configuration:

- 1 VRF outdoor unit + 1 AHU
- 1 VRF outdoor unit + 1 AHU (external heat exchanger)
- 1 VRF Outdoor unit + multiple AHUs
- 1 VRF Outdoor unit + VRF indoor units + AHUs

[Example] DX-Kit  
 Left: Control Box (C Box)  
 Right: Expansion Valve Box (EXV Box)

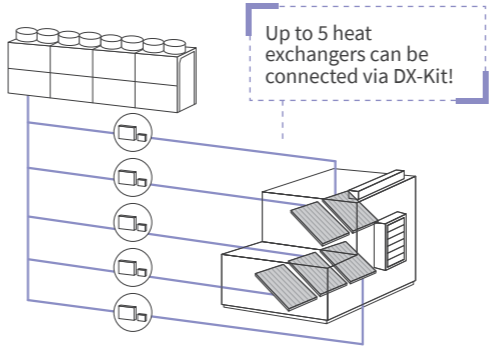

Various available AHU capacity connections.

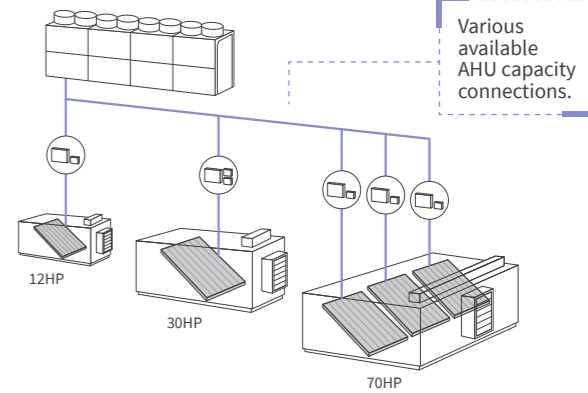

Flexible combination with VRF indoor units.

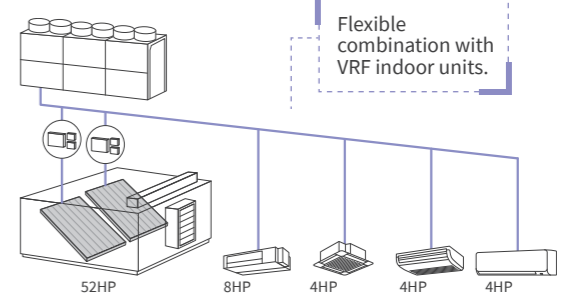



## New generation: simple and smart!

Everyone deserves comfort, but comfort does not mean the same to everyone. That's why control is key. Our controllers offer best-in-class simplicity. Using our praised central stations, building managers can instantly optimize air conditioning in targeted zones. For occupants, our new advanced color controller provides intuitive navigation with a premium design. With airCloud Pro, our exclusive new-generation solution, users can manage from one indoor unit to several systems remotely via IoT (web/smartphone).

---

# CONTROLLERS

---

## 105 Centralized controllers

- 105 Line-up overview
- 107 **airCloud Pro**
- 109 Central Station EX
- 110 Central Station EZ
- 110 Central Station MINI

---

## 111 Individual controllers

- 111 Line-up overview
- 113 **airCloud Tap**
- 115 Advanced color wired remote controller
- 117 Eco-compact controller
- 119 Wired remote controller
- 120 Advanced wireless remote controller
- 120 Wireless remote controller
- 120 Receiver kit

---

## 121 Accessories

---

## 123 H-LINK: enjoy more freedom

---

# Centralized controllers

Control each indoor unit, one specific zone or even multiple systems from one place!

## airCloud Pro (HC-IoTGW)

- Remote access via smartphone app or web.
- Unlimited number of systems, zones and users.
- Intuitive scheduling function.
- Troubleshooting with access to error history and alerts.
- Filter sign display to quickly overview daily maintenance needs.
- Ideal for all types of applications.

## CENTRAL STATION EX (PSC-A128EX3)

- Control capacity: max 2,560 indoor units (+15x Extension Adapter PSC-AD128EX3).
- With energy calculation software (PSC-AS01EXC), determine each tenant's energy usage.
- Easy monitoring with simplified interface.
- Best option for middle-large size buildings.
- Remote access! Operate Central Station EX from your laptop PC or touch-panel PC.

## CENTRAL STATION EZ (PSC-A64GT)

- Control capacity: max 64 remote control group of indoor units.
- Compact and optimized 170x250mm body screens fitting in even small walls.
- Easy monitoring with simplified interface.
- Best option for middle size buildings.

## CENTRAL STATION MINI (PSC-A32MN)

- Control capacity: max 32 remote control group of indoor units.
- Compact and optimized 120x140mm body screens fitting in even small walls.
- Easy monitoring with simplified interface.
- Best option for small size buildings.

## SMALL TO LARGE SYSTEMS & FIXED OR CLOUD-BASED

		airCloud Pro HC-IoTGW	CENTRAL STATION EX PSC-A128EX3	CENTRAL STATION EZ PSC-A64GT	CENTRAL STATION MINI PSC-A32MN	
Capacity comparison	Total Connection capacity	RC group: 64 (*6) Group: 64 (*6) Block: Unlimited (*7) Area: Unlimited (*7) Indoor unit: 80 (*6) Outdoor unit: 16 (*6)	2,560 (*1) 2,048 (*1) 512 (*2) 512 (*2) 2,560 (*1) 1,024 (*1)	64 64 4 -	32 32 2/4/8/16 -	
	Building scale	Small to Large	Large	Medium	Small	
	Operation	Web + Mobile Phone	Touch screen + Web (New!)	Touch screen	Touch screen	
	Display	Operation panel size options	Adaptive	7	2	3
		Layout	-	●	-	-
		List options	-	3	-	-
	Operation unit	All together	●	●	●	●
By layout		-	●	-	-	
By area		●	●	-	-	
By block		●	●	●	●	
By group		●	●	-	-	
By RC group		-	-	●	●	
By indoor unit		●	●	-	-	
Control Function	Main 5 functions (*5)	●	●	●	●	
	Individual controller lock	●	●	Δ (*3)	●	
	Filter sign reset	●	●	●	●	
	Outdoor unit capacity control	-	●	-	Δ (*4)	
Monitor Function	Outdoor unit noise control	-	●	-	-	
	Main 5 functions (*5)	●	●	●	●	
	Individual controller lock	●	●	●	●	
	Alarm status & code	●	●	●	●	
	Filter sign	●	●	●	●	
	Air inlet temperature of indoor unit	-	●	-	●	
Schedule Function	Air inlet temperature of outdoor unit	-	●	-	●	
	Weekly	●	●	●	-	
	Setting times per day	16	16	10	10	
	Special day setting	5	5	-	-	
	Holiday setting	-	●	-	-	
Other function	Annual/Summer/Winter schedule	Future Version	●	-	-	
	Alarm history (records number)	Unlimited	10,000	100	100	
	External in/output history	-	1,000	-	-	
	Management report visualization(*11)	Energy Estimation (*8) - Future	●	●	●	
IoT Functions	Data output by external media	Download from Web - Future	SD card, USB flash device	-	-	
	Individual WRC clock synchronization	-	●	-	-	
	Connectivity	Ethernet + 4G (*9)	-	-	-	
	Future Extendability	Firmware OTA (*10) Web + Mobile Update	-	-	-	

(\*1) One Extension Adapter (PSC-AD128EX3) enable CENTRAL STATION EX to control additional 160 RC groups /128 groups / 160 IDUs / 64 ODU, and up to 15 adapters can connect to one Central Station EX.

(\*2) No restriction on the number of H-LINK.

(\*3) Individual Feature Control in Each Remote Controller is not available.

(\*4) Applicable only with Schedule function or external signal input. You cannot set it up directly from monitoring panel.

(\*5) Main 5 functions meaning: 1) Run/Stop 2) Operation mode 3) Temperature setting 4) Fan speed 5) Louver control.

(\*6) Ability to connect unlimited number of "HC-IoTGW" in one project and control all AC units via one single screen on Web or Mobile Phone.

(\*7) Unlimited creation of zones, across multiple "HC-IoTGW" units within the same project.

(\*8) Visualization of outdoor unit energy consumption.

(\*9) 4G available through optional 4G module; 4G module package comes with global SIM and pre-paid global data plan.

(\*10) OTA: Over-the-air firmware update, provides always up-to-date firmware and latest functionalities.

(\*11) Mini, EZ: Accumulated operation time ( min ), Accumulated thermo - ON ( min ).

EX: Accumulated operation time ( min ), Accumulated thermo - ON time ( min ), Average air intake temperature of indoor unit, Average air intake temperature of outdoor unit, Average setting temperature, Average RC sensor temperature.

# Centralized controllers

airCloud Pro

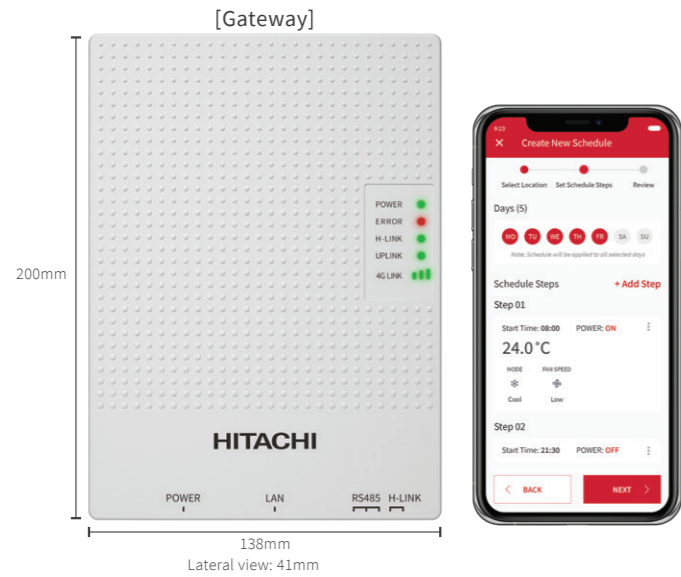

## Specifications

Gateway	HC-IoTGW
Net weight (g)	540
Connection capacity	16 outdoor + 80 indoor units
Power supply (V)   (Hz)	100-240, AC   50/60
Max. power consumption (W)	10
Communication port	1 H-LINK, 1 RS485 Port
Internet connection	LAN (Ethernet) or 4G <sup>3</sup>
External interface (log storage)	1 micro SD card slot

Control is in your hands.  
24/7 control at your fingertips on smartphone, tablet, or PC.

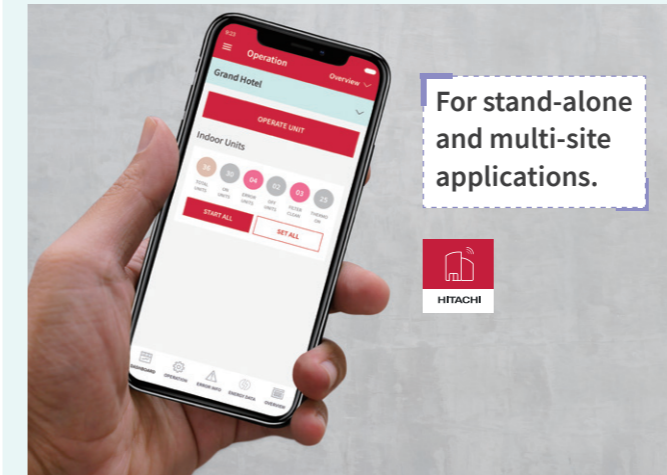

### ✓ Intuitive simplicity

airCloud Pro is designed to make your job easier. An intuitive app that anyone can use, airCloud Pro makes managing your VRF systems easier than ever before.

### ✓ Control from anywhere

Enjoy the freedom of remote access from your smartphone, tablet or laptop. airCloud Pro allows you to remotely control your VRF system(s) from a single app, saving you travel time.

## Functions

IoT connection (cloud-based)	<ul style="list-style-type: none"> <li>• Access via smartphone app or web</li> <li>• Unlimited number of gateways</li> <li>• Unlimited number of locations</li> <li>• Unlimited number of users</li> </ul>
Operation unit	<ul style="list-style-type: none"> <li>• Per entire location</li> <li>• Per system</li> <li>• Per zone (unlimited zone creation)</li> <li>• Per indoor unit remote control group</li> </ul>
Control function	<ul style="list-style-type: none"> <li>• On/Off • Mode • Set temperature</li> <li>• Fan speed • Louver • RC lock</li> <li>• Filter sign reset</li> </ul>

Monitor Function	<ul style="list-style-type: none"> <li>• On/Off • Mode • Set temperature</li> <li>• Air intake temperature • RC sensor temperature (*3)</li> <li>• Air intake temperature of outdoor unit</li> <li>• Fan Speed • Louver • RC prohibition</li> <li>• Thermo-ON information • Filter sign/Auto cleaning fault</li> <li>• Alarm status/Alarm codes</li> </ul>
Schedule function	<ul style="list-style-type: none"> <li>• Weekly schedule • Easy selection of days and zones</li> <li>• Setting items in schedule is as below; • On/Off</li> <li>• Operation mode • Setting temperature</li> <li>• Louver • Fan speed</li> </ul>

\*All Groups Run/Stop" command signal exception function for selected groups is available by "Exception of Run/Stop Operation," function.

## System configuration.



## Recommended facilities (examples.)



## Is airCloud Pro for me?

All VRF users can enjoy these benefits!

- Save energy
- Save time and unnecessary transportation
- Delegate VRF systems administration
- Create a comfortable climate for guests

## Future-proof

With updates and new features added regularly, airCloud Pro ensures you are always up to date.



- Compatible with new and former
- Hitachi Variable Refrigerant
- Flow systems\*1

## A simple yet powerful tool.

### 👍 Simplify your job

The pilot app makes managing your VRF systems easy.

### 🌍 Save more energy

Monitor energy consumption and optimize usage.

- **Centralized control**  
Control your entire VRF system or selected zones in one touch.
- **Simplified troubleshooting**  
A clear error history, concise error description and follow-up.
- **Smartphone alerts**<sup>2</sup>  
In the event of a critical malfunction.
- **Flexible user management**<sup>2</sup>  
Add users and custom access restrictions.

- **Energy consumption data**<sup>2</sup>  
Simple graphs visualize power consumption.
- **Intuitive scheduling**  
Plan operations ahead based on your business hours.
- **Individual controller lock**  
Prevent inappropriate usage from occupants.

### ❤️ Create better comfort

Adjust temperature, fan speed, and modes with ease, creating total comfort and the ideal climate throughout your building.

An integrated weather forecast<sup>2</sup> display helps you determine the most suitable conditions for your indoor spaces all year round.

### 🔧 Easy plug-and-play

Our airCloud gateway makes installation a breeze.

Connect to the airCloud via 3G/4G<sup>3</sup> or ethernet and pair your VRF systems via QR code scan. With automatic detection of indoor units and an optimized installer view, configuring your site and zones has never been quicker.

### + data security

**Best-in-class standards:**  
TLS.v1.2, HTTPS 2038 encryption.

**Minimal personal details:**  
Only your name, email address and phone number are required for login.

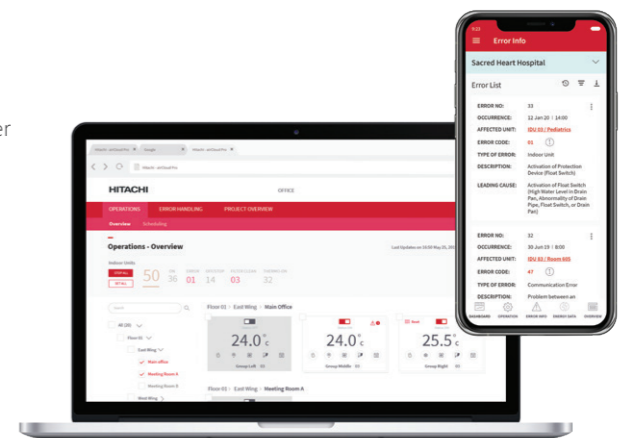

\*1 Confirm compatibility of your VRF installation with your Hitachi Cooling & Heating representative.

<sup>2</sup> Functions not available as of September 2019, coming soon.  
<sup>3</sup> 4G module available as a side accessory.

# Centralized controllers

## CENTRAL STATION EX FOR LARGE-SCALE BUILDINGS

(PSC-A128EX3)



For middle or large-scale buildings such as hotels, educational facilities, and hospitals, our Central Station EX features a highly intuitive and functional 12.1-inch wide, wall-mountable, color LCD screen. Control up to 2,560 indoor units with our proprietary H-LINK system with 15 extension adapters (PSC-AD128EX3).

Also, with energy calculation software (PSC-AS01EXC), Central Station EX can help you easily manage each tenant's electricity & report the power consumption of VRF system for each tenant.

Install by add-on software and activate, then, you can select electricity ratio or usage ratio from several methods.

### Capacity

H-LINK	16
RC group	2,560 (*1)
Group	2,048 (*1)
Block	512 (*2)
Area	512 (*2)
Indoor unit	2,560 (*1)
Outdoor unit	1,024 (*1)
Building scale	Large

#### Extension adapter



PSC-AD128EX3

(\*1) 1 extension adapter (PSC-AD128EX3) enables Central Station EX to control additional 160 RC groups / 128 groups / 160 IDUs / 64 ODUUs. Central Station EX can connect up to 15 adapters.  
(\*2) No restriction on the number of H-LINK

#### Energy calculation software\*



PSC-AS01EXC

### Specifications

Rated power supply	100~240VAC ±10% (50/60Hz)
Electrical power consumption	50W (Max.)
Communication unit	Units of Adopting for H-LINK
Communication line	Two-wire non-polar
Communication speed	9,600bps
Wiring length	1,000m (Total Length)
Display	12.1 inch TFT color liquid crystal display
Display control	Touch Panel

### Functions

Operation unit	All together Each area Each block Each group Each indoor unit
----------------	---------------------------------------------------------------------------

Control function	On/Off Mode Set temperature Fan speed Louver RC prohibition Filter sign reset Function selection for indoor units (*1) Function selection for outdoor units (*2) Capacity control for outdoor units (*2) Lower noise control for outdoor units (*2)
------------------	-----------------------------------------------------------------------------------------------------------------------------------------------------------------------------------------------------------------------------------------------------------------------------------

Monitor function	On/Off Mode Set temperature Air intake temperature RC sensor temperature (*3) Air intake temperature of outdoor unit Fan Speed Louver RC prohibition Thermo-ON information Filter sign/Auto cleaning fault Alarm status/Alarm codes
------------------	----------------------------------------------------------------------------------------------------------------------------------------------------------------------------------------------------------------------------------------------------------------------

Schedule function	Each of the following settings is available in 3 different [annual] [summer][winter] categories: → Weekly schedule → Up to 16 actions can be set per day → Exception day setting: 5 different types → Holiday setting
-------------------	-----------------------------------------------------------------------------------------------------------------------------------------------------------------------------------------------------------------------------------

History	Setting items in schedule is as below: • On/Off • Operation mode • Setting temperature • Louver • Fan speed • RC operation prohibition • Capacity control for outdoor units • Lower noise control for outdoor units
---------	---------------------------------------------------------------------------------------------------------------------------------------------------------------------------------------------------------------------------------------------

Management report visualization	Alarm history: 10,000 records External In/Output history: 1,000 records Pulse input history: 6 months  Up to 2 years worth of data history can be displayed for the following: • Accumulated operation time (min.) • Accumulated thermo-ON time (min.) • Average air intake temp temperature of indoor unit • Average air intake temperature of outdoor unit • Average setting temperature • Average RC sensor temperature
---------------------------------	----------------------------------------------------------------------------------------------------------------------------------------------------------------------------------------------------------------------------------------------------------------------------------------------------------------------------------------------------------------------------------------------------------------------------------------------------------

Energy saving:	• Run/Stop • RC prohibition • Temperature shift (For Cool/Dry mode: +1.0°C→+9.0°C (+1.0°F→+18.0°F)) • Mode shift (Mode shifted to Fan when in Cool/Dry mode) • Capacity control on outdoor units • Lower noise control for outdoor units
----------------	---------------------------------------------------------------------------------------------------------------------------------------------------------------------------------------------------------------------------------------------------------------

External input / output	Control/Monitor → Controlled items: • Run/Stop • Mode (Cool) → Monitored items: • Run/Stop • Mode (Cool) • Alarm state
-------------------------	---------------------------------------------------------------------------------------------------------------------------------------------

Others:	• Power consumption signal input • Emergency stop
---------	------------------------------------------------------

(\*1) Some indoor units may not fully support all functions.  
(\*2) Available for applicable outdoor units only.  
(\*3) Whether this is shown on the screen depends on the remote controller settings.

### Remote access.

You can now operate Central Station EX from your laptop PC or touch panel PC. Install our software and you can connect from anywhere, using our VPN network.

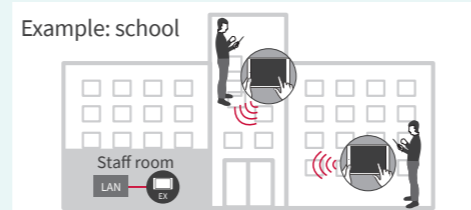

## CENTRAL STATION EZ FOR MEDIUM-SCALE BUILDINGS

(PSC-A64GT)



With easy control via an 8.5 inch color touch panel, its detailed control functionalities such as Weekly Scheduling, Operation hours tracking, and more, help you save energy. Up to 64 remote-controlled groups and up to 160 indoor units can be connected to the Central Station EZ.

### Capacity

RC group	64
Group	64
Block	4
Indoor Unit	160
Outdoor Unit	64
Building Scale	Small-Medium

### Specifications

Rated Power Supply	1-, AC 100-240V, 50/60Hz
Electrical Power Consumption	30W (Max.)
Communication Unit	Units of Adopting for H-LINK
Communication Line	Non-polar 2-wire
Communication Speed	9,600bps
Wiring Length	1,000m (Total Length)
Display	8.5-inch Wide Color LCD (Full Dot)
Display Control	Touch Panel

### Functions

Monitor Function	• Run/Stop/Abnormality • Setting Temperature • RC Operation Prohibited Setting • Accumulated Operating Time • Operation Mode • Setting Fan Speed • Setting Louver • Filter Sign • Alarm Code
Control Function	• Run/Stop* • Fan Speed • Operation Mode • Louver • Temperature Setting • RC Operation Prohibited • Filter Sign Reset

\*The "All Groups Run/Stop" command signal exception function for selected groups is available via the "Exception of Run/Stop Operation" function.

## CENTRAL STATION MINI FOR SMALL-SCALE BUILDINGS

(PSC-A32MN)



With easy control via an 5.0 inch color touch panel, its detailed control functionalities such as weekly scheduling, operation hours tracking, help you save energy. Up to 32 remote-controlled groups and up to 160 indoor units can be connected to the Central Station mini.

### Capacity

RC group	32
Group	32
Block	4 Patterns (2/4/8/16)
Indoor Unit	160
Outdoor Unit	64
Building Scale	Small

### Specifications

Rated Power Supply	1-, AC 100-240V, 50/60Hz
Electrical Power Consumption	20W (Max.)
Communication Unit	Units of Adopting for H-LINK
Communication Line	Non-polar 2-wire
Communication Speed	9,600bps
Wiring Length	1,000m (Total Length)
Display	5.0-inch Wide Color LCD (Full Dot)
Display Control	Touch Panel

### Functions

Monitor Function	• Run/Stop/Abnormality • Setting Temperature • RC Operation Prohibited Setting • Accumulated Operating Time • Operation Mode • Setting Fan Speed • Setting Louver • Filter Sign • Alarm Code"
Control Function	• Run/Stop* • Fan Speed • Operation Mode • Louver • Temperature Setting • RC Operation Prohibited • Filter Reset Signal

\*"All Groups Run/Stop" command signal exception function for selected groups is available by "Exception of Run/Stop Operation." function.



# Individual controllers

## A new generation of room controller now available!

With two new room controllers, the experience of controls has become easier and more stylish than ever

### NEW ADVANCED-COLOR CONTROLLER (PC-ARFG1-\*)



Contactless settings via **airCloud Tap**

#### Complete controls in a rich interface

- Colored screen displaying visual charts and descriptive texts
- Access to all existing Hitachi VRF indoor unit features including user features settings, installation & maintenance features settings.
- Energy consumption monitoring
- Ideal for indoor units with motion sensors, cassettes with elevating grilles
- Multiple languages available

\*Except Sleep Mode timer

### NEW ECO-COMPACT CONTROLLER (PC-ARC-\*)



Contactless settings via **airCloud Tap**

#### Value without compromise

- Segment screen displaying pictograms
- Essential controls in a glimpse
- On/Off weekly schedule
- Some extra advanced features such as GentleCool, Power-Saving Peak-Cut mode and Sleep Mode Timer
- Embedded IR receiver, ideal for ducted units

## Still available for order

### WIRED REMOTE CONTROLLER (HCWA10NEGQ)



- 88mm square controller with LCD screen.
- Smaller body with multiple features.
- Best option for spaces frequented by recurring users, e.g. offices.

## Controls from anywhere in the room

### ADVANCED WIRELESS REMOTE CONTROLLER (PC-AWR)



- Wireless remote controller with more features.
- Several temperature units and settings available; 0.5°C/1.0°C/1.0°F.
- Ideal for controlling the unit from anywhere in the room, e.g. residential spaces.

### WIRELESS REMOTE CONTROLLER (PC-LH7QE)



- Budget option featuring primary control settings.
- 1.0°C temperature step.
- Ideal for visitors to control the unit from anywhere in the room, e.g. hotel suite.

## From basic to advanced controls

		NEW PC-ARFG1	NEW PC-ARC	HCWA10NEGQ	PC-AWR	PC-LH7QE
Connection Capacity	No of RC-Group	1	1	1	-	-
	No of indoor units	16	16	16	-	-
Product Size	Width*Height*Depth (mm)	120*120*16.5 (D: thinnest part)	90*90*15.5 (D: thinnest part)	88*88*15.5	140*55*16.8	140*52*19.3
Screen		Color LCD with backlight	Segment LCD with backlight	Segment LCD with backlight	Segment LCD	Segment LCD
Embedded IR receiver		-	●	-	-	-
Smartphone App	Use With airCloud Tap	● (support NFC)	● (support NFC)	-	-	-
Essential Operations	Run / Stop	●	●	●	●	●
	Operation Mode	●	●	●	●	●
	Auto Mode Setting	●	●	●	●	●
	Temperature Setting	●	●	●	●	●
	Fan Speed	●	●	●	●	●
	Louver Direction	●	●	●	●	●
	Simple Timer	●	● (On/Off Timer)	● (On/Off Timer)	● (On/Off Timer)	● (On/Off Timer)
	Weekly Operation Schedule	●	●	●	-	-
	Power Savings Setting	●	● (Capacity Control only)	-	-	-
	Night Quiet Operation	●	-	-	-	-
Power Savings/Night Quiet Schedule	●	-	-	-	-	
Power Consumption Display	●	-	-	-	-	
AutoBoost	●	-	-	-	-	
Comfort Setting	●	● (GentleCool only)	-	-	-	
Advanced Feature Settings	Sleep Mode	-	●	-	-	-
	Motion Sensor Setting (1)	●	-	-	-	-
	Setback Setting	●	-	-	-	-
	Elevating Grille	●	-	-	-	-
	Filter Reminder Time Reset	●	-	-	●	●
	Filter Auto-Cleaning (1)	●	-	-	-	-
	Individual Louver Setting	●	●	●	-	-
	Louver Open/Close	●	-	-	-	-
	Ventilation	●	-	-	-	-
	Total Heat Exchanger SET	●	-	-	-	-
Display Settings	Adjusting Date/Time	●	●	●	-	-
	Daylight Saving Time	●	-	-	-	-
	Run Indicator Brightness Adjustment	●	● (Only On/Off setting)	-	-	-
	Display Adjustment	●	-	-	-	-
	Temperature Units (°C/°F)	●	-	●	●	- (°C only)
	Temperature setting at 0.5°C step	●	●	●	●	- (1.0°C only)
	Room Temperature Display	●	-	-	-	-
	Language available	EN, JPN, CN (traditional & simplified), FR, ES, PT	EN	EN	EN	EN
	Keypad Touch Sound	●	●	● (Cannot turn off)	-	-
	Lock Function	●	● (Lock function individually)	● (Lock whole keypad)	-	-
Service Functions	Password Setting	●	-	-	-	-
	Hotel Mode	●	-	-	-	-
	Power Saving Details Setting	●	-	-	-	-
	Temperature Range Restriction	●	● (in Function Selection)	● (in Function Selection)	-	-
	Dual Setpoint	●	-	-	-	-
	Main/Sub Display	●	-	-	-	-
	Set Room Name	●	-	-	-	-
	Set Contact Information	●	-	-	-	-
	NFC Setting	●	●	-	-	-
	Simple Maintenance Check Menu	●	-	-	-	-
Installation Functions	Test Run	●	●	●	-	-
	Function Selection	●	-	-	-	-
	Thermistor Selection	●	● (in Function Selection)	● (in Function Selection)	-	-
	Input/Output	●	●	●	-	-
	Thermistor Calibration in Controller	●	● (in Function Selection)	-	-	-
	Fan Speed At Thermo-Off	●	● (in Function Selection)	● (in Function Selection)	-	-
	Indoor Unit Address Change	●	●	●	-	-
	Address Check Operation	●	-	-	-	-
	Address Initialization	●	-	-	-	-
	Setting Initialization	●	●	-	-	-
Check Menu	Main/Sub Controller Setting	●	●	●	-	-
	Priority Setting	●	-	-	-	-
	Cancel Preheating Control	●	-	-	-	-
	Elevating Grille Setting	●	-	-	-	-
	Power Up Setting	●	-	-	-	-
	Setback Trigger Unit	●	-	-	-	-
	Refrigerant Leak Sensor Setting	●	-	-	-	-
	Check 1	●	●	●	-	-
	Check 2	●	●	●	-	-
	Alarm History Display	●	●	●	-	-
Other features	Display Model Number	●	-	-	-	-
	Check PCB of the Units	●	-	-	-	-
	Self Check	●	●	-	-	-
	Synchronize Date/ time with Central Controller	● (Only available from Central Station EX PSC-A128EX3)	● (Only available from Central Station EX PSC-A128EX3)	-	-	-
	Stop operation delay	●	●	-	-	-
	Emergency operation	●	●	-	-	-
	Two WRC Control	●	●	-	-	-
	Alarm Display	●	●	●	-	-
	Filter cleaning reminder sign display	●	●	●	-	-

(\*1) Available when the controller is connected with selected indoor unit offering this feature.

# Individual controllers

airCloud Tap

Download airCloud Tap!



For HVAC professionals: Quicker commissioning & service by airCloud Tap Contactless 'read and write' settings

### Ready-to-tap controllers

- NFC chip embedded in the controller

### Convenience using with a mobile app

- Easy browsing of all settings by scrolling phone's screen
- Complete text description of each setting

### More savvy than traditional settings by physical device

- Less buttons to press, no AC hardware to manipulate
- Time saving setting process
- Reduced need of documentation support



## What you can do with airCloud Tap | some highlights:

### Installation & Commissioning

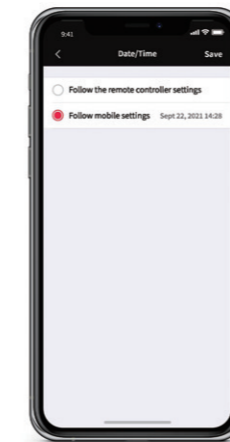

#### Date/time setting

import the date & time from your phone into the controller

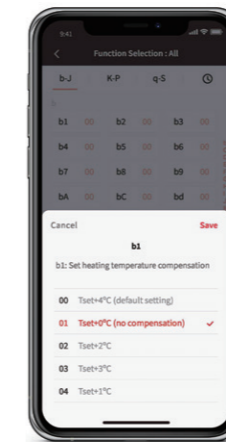

#### Function selection

Scroll your phone's screen and browse over 140 commissioning settings available

### Operation

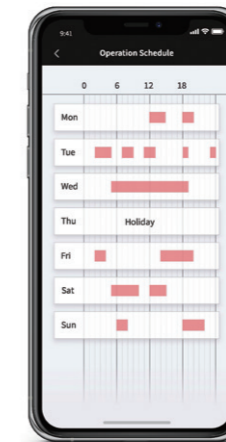

#### Scheduling

Save preferred AC schedule and save to copy to other controllers of the same building

### Maintenance & Service

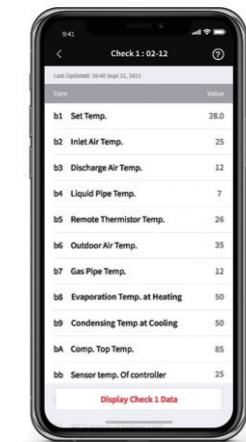

#### Troubleshooting

Visualize all the service check data on your phone

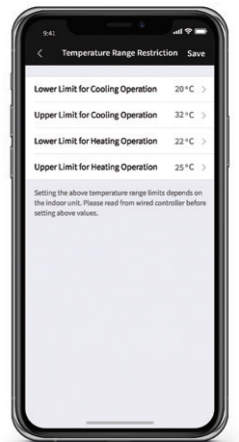

#### Temperature range restrictions

Apply min/max set temperature to prevent excessive cooling

## Special tip: Save time on multi-room commissioning

Specify settings for one room, save them, then apply these settings to other similar rooms in one tap. Particularly useful for multiple zones with similar needs! Hotel guestrooms, office meeting rooms, condominium units, etc.

### STEP1

Read the settings from one device and save settings.

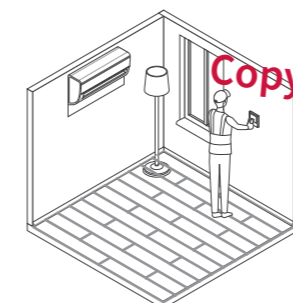

### STEP2

Hold the mobile device over each product and write settings of STEP1.

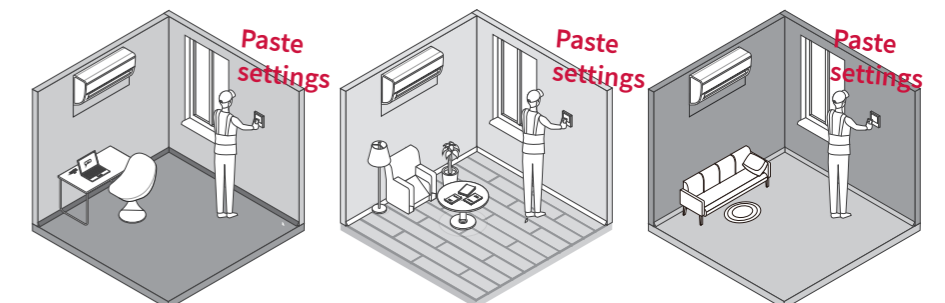

## How does airCloud Tap works?



1. Activate the NFC function on the AC equipment.

2. Open the airCloud Tap app and tap the AC equipment with your phone to read the current settings.

3. Edit the desired settings on your phone.

4. Tap again your equipment to apply the new settings.

# Individual controllers

NEW

## ADVANCED COLOR WIRED REMOTE CONTROLLER (PC-ARFG1)

### Simplicity with style

Combining the best of form and function, enjoy climate control made easy with Hitachi's most advanced wall controller yet.



- Super user-friendly interface
- Easy-to-navigate menus
- Available in 7 languages
- Pictograms and colors for an optimal user experience

#### Award-winning design

- Minimalist design aesthetic
- Distinctive curves for ergonomics
- Modern and subtle colors

With **Near-field communication (NFC) contactless-enabled system** commissioning via the airCloud Tap smartphone app, you can now save, copy, and paste settings to the Advanced Color Controller with a simple tap.



- 1 Room name
- 2 Set temperature
- 3 Operation mode
- 4 Indoor unit ON/OFF light
- 5 Indoor unit ON/OFF
- 6 Navigation buttons
- 7 Back button
- 8 OK button
- 9 Fan speed
- 10 Louver direction
- 11 Access to menu
- 12 Filter cleaning reminder

#### Outer dimensions (H×W×D)

- 120×120×16.5mm (thinnest part)
- 120×120×21.5mm (thickest part)

#### Capacity

Power Supply	Powered by indoor unit, 15VDC±10%
	180g (approx.)
Installation	Indoor, on the wall or switch box
Connection capacity	Up to 16 indoor units (with the same wired remote controller)
▲ Display	When two wired Advanced Controller units are connected to the same indoor unit, the maximum brightness of each controller will be halved

\* H is the height of the unit from the front, without the protrusion at the bottom.

### System configuration example

Possibility of 2 Wired Controller Connection

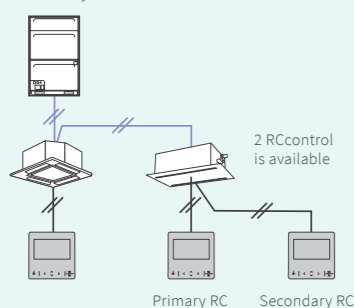

2 RCcontrol is available

Up to 16 IDU connection

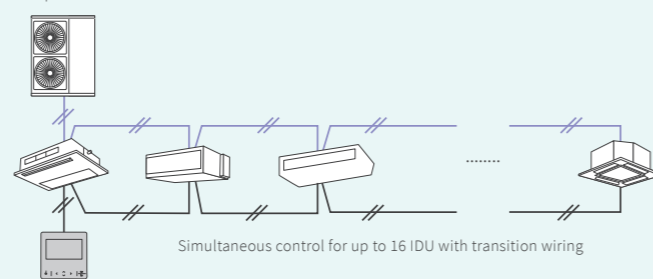

Simultaneous control for up to 16 IDU with transition wiring

— H-LINK  
— Remote Control Cable

### Energy optimization

Power-saving features enable VRF system operators to optimize energy usage

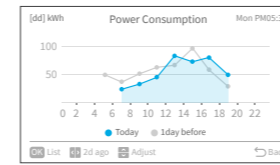

Energy consumption visualization

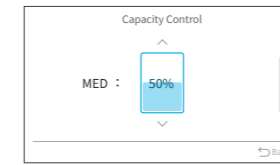

Capacity - peak cut control

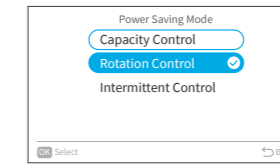

Choice of power-saving method

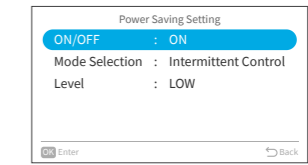

Power saving setting

Set specific schedules for features like peak capacity cuts and the thermal operation rotation of indoor units, enabling you to match energy-saving operation hours with your utility tariffs plan. Building managers can also set the minimum and maximum temperature range for occupants and visualize energy consumption with daily, weekly or monthly comparison options.

### From basic to advanced functions

Users can control the main temperature settings from Advanced-Color controller's main screen. In addition, more advanced comfort settings help customizing the air to their occupants' specific needs.

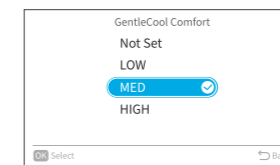

**GentleCool** limits the temperature of conditioned air, preventing cold drafts for optimal comfort.

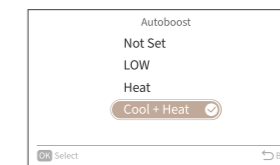

**AutoBoost** automatically activates for 30 minutes every time the AC is turned on, helping the room reach the desired temperature faster.

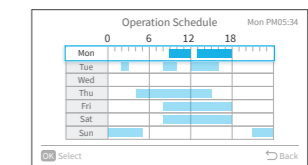

**AC Scheduling** is easier than ever, thanks to flexible features such as the holiday calendar.

### The latest VRF features

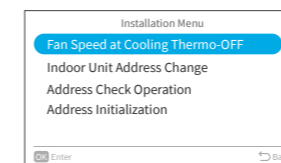

**NEW** Fan speed at thermo-off reduces air circulation when cooling is not effective.

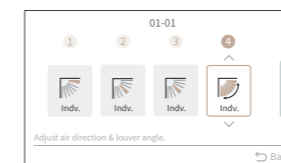

Individual **4-way cassette louvers** optimizes air flow direction to each corner layout.

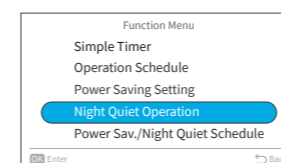

Schedule **Night Quiet** mode to minimize the outdoor unit's operation noise so you and your neighbors get a better night's sleep.

### Special features for hotels

**NEW** **Hotel mode** enables instant access to the functions demanded most by hotel guests. After guests check out, housekeeping can reset the controller in one touch. **Hotel setback** allows interlocking with hotel key cards. When the room is vacant, the indoor unit switches to a selected energy-saving setback temperature, ensuring the room remains at a comfortable temperature when unoccupied.

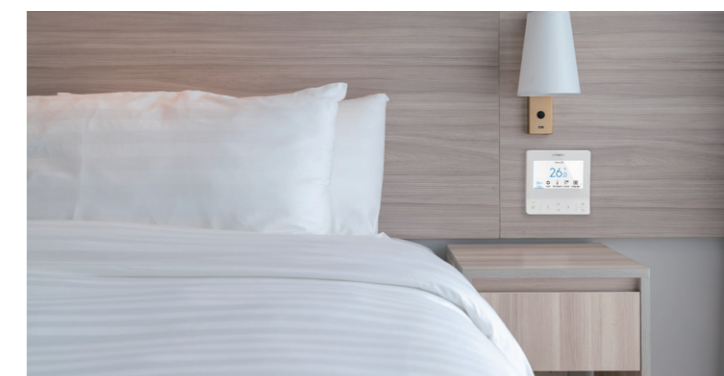

### Ideal for indoor units with motion sensor features

**NEW** Active intelligent comfort features connected to your indoor unit's motion sensor and/or radiant sensor\*: choice of direct/indirect air flow, **FloorSense Cool NEW** and the exclusive **Crowd-Sense NEW** to prevent heat peak from rapid crowd arrival.

# Individual controllers

## NEW ECO-COMPACT CONTROLLER (PC-ARC-\*)

### Climate control in a compact size

- Great value for money that combines the best of form and function.
- Minimalist design aesthetic that reflects Hitachi's Duality Design philosophy.



- Budget-sensitive VRF projects
- Users who prefer simple controls
- Functional spaces

### Stylish & Intuitive

With distinctive curves and an aesthetic inspired by Hitachi's Duality Design philosophy, the Eco-Compact Controller is stylish, ergonomic, cost-effective, and convenient. Enjoy climate control made easy through an optimized interface with easy-to-understand pictograms for a truly intuitive user experience.

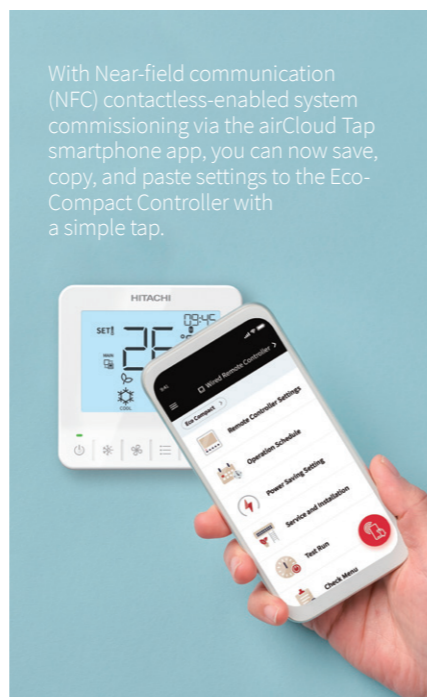

With Near-field communication (NFC) contactless-enabled system commissioning via the airCloud Tap smartphone app, you can now save, copy, and paste settings to the Eco-Compact Controller with a simple tap.



- 1 Set Temperature
- 2 Operation mode
- 3 Run indicator
- 4 On/Off button
- 5 Operation mode button
- 6 Fan speed button
- 7 Menu buttons
- 8 Directional key
- 9 Fan speed
- 10 Louver direction
- 11 Current time

### Outer dimensions (H×W×D)

90mm×90mm×15.5mm(thinnest part)  
90mm×90mm×18.5mm(thickest part)

### Capacity

Power Supply	Powered by indoor unit, 15VDC±10%
	100g (approx.)
Installation	Indoor, on the wall or switch box
Connection capacity	Up to 16 indoor units (with the same wired remote controller)

## System configuration example

Possibility of 2 Wired Controller Connection

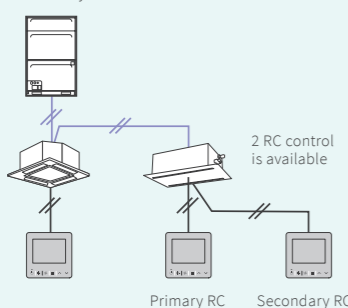

Primary RC Secondary RC

Up to 16 IDU connection

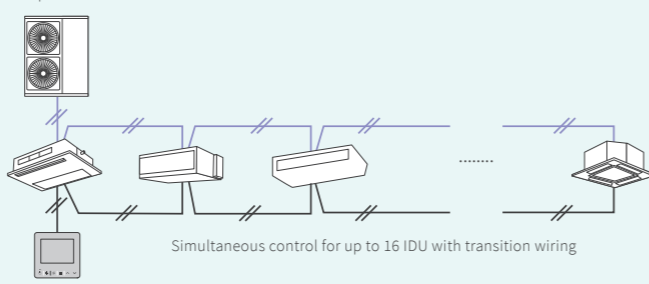

Simultaneous control for up to 16 IDU with transition wiring

— H-LINK  
— Remote Control Cable

## Easy access to essential controls

Simplified navigation enables users to change temperatures and adjust essential controls directly from the home screen in one touch.



Set temperature with 0.5°C precision\*

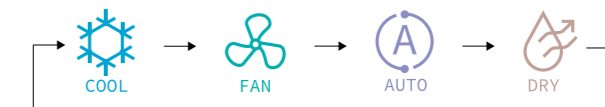

Operation modes

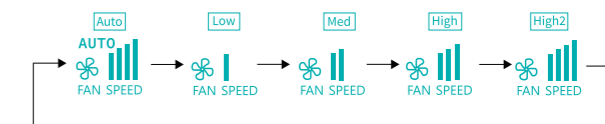

Fan speed



Louvers' positions

## Energy-saving features

The Eco-Compact Controller includes energy-saving features to minimize unnecessary AC operation.



The **Peak-Cut** feature enables users to save even more energy during peak consumption periods.



**Weekly scheduling** automatically turns the indoor unit on/off at set times, great for classrooms, retail businesses or other premises with regular opening hours.

## Accrued comfort

The Eco-Compact Controller includes energy-saving features to minimize unnecessary AC operation.



Include **GentleCool**, which controls the discharged air temperature for a smooth cooling down and prevents cold drafts.



**AutoBoost** activates for 30 minutes every time the AC is turned on, helping the room reach the desired temperature faster with a powerful automatic mode, which is ideal for meeting rooms and other areas requiring fast temperature reach.

## Supports easy maintenance

A filter symbol appears when it's time to clean the filter. In the event of an error, the error code and the related indoor unit number is clearly displayed for ease of maintenance.

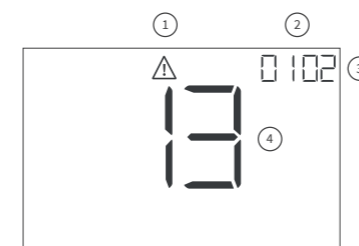

- 1 Alarm Icon
- 2 Indoor Unit No. (Refrigerant system)
- 3 Indoor Unit No. (Refrigerant system)
- 4 Alarm Code

## Special features



**For residential users:** set the Sleep mode timer **NEW** to gradually change the room temperature for a better night's sleep. The unit will turn off automatically after a set time.



**For hotels:** interlock the Eco-Compact Controller with your hotel key card receiver and activate setback temperature while guest is away.

## Embedded IR receiver

For use with the Wireless Remote Controller. Ideal for indoor units without embedded IR receiver (ex: ducted units)

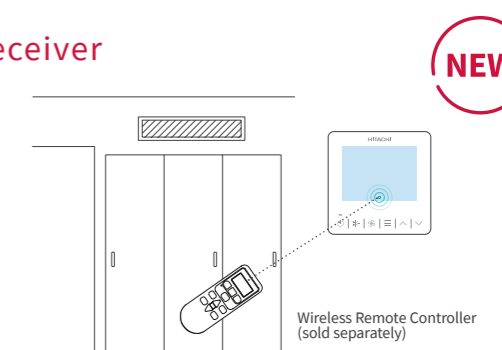

When IR receiver receives the commands, the buzzer sounds.  
\*Compatible HCRB10NEWQ and PC-LH7QE/PC-LH7QE1 wireless controllers

# Individual controllers

## WIRED REMOTE CONTROLLER (HCWA10NEGQ)

**Temperature display**  
Room temperature  
RT 26.0°C RT 79.0°F

**Set temperature**  
SET 26.0°C SET 79.0°F

ON/OFF Button  
Mode Button

Liquid Crystal Display (LCD) Screen

Up Button & Down Button

**Operation Mode**

- Cooling Mode ❄️
- Dry Mode 💧
- Fan Mode 🌀
- Auto Mode 🔄

Fan Speed Setting  
Timer/Clock Setting

**Fan Speed**

MAX (flickering) MAX

MIN

**Timer Setting**

- ON Timer On
- OFF Timer Off
- ONCE Timer Valid for One Time
- DAILY Timer Valid for One Day
- WEEKLY Timer Set for a Week

Outer dimensions (H×W×D)  
(mm) 88.0×88.0×15.5

### Functions

Run/Stop	Operation Mode
Auto Mode Setting	Temperature Setting
Temperature Setting Rate 0.5°C/1.0°C/1.0°F	Fan Speed 3/4/6 taps
Louver Direction	Sensor Condition Check
Sensor Data Check	Alarm History Display
Test Run	Function Selection (Optional Function Setting)
Thermistor Selection	Thermistor Calibration
Input / Output Setting	Indoor Unit Address Change
Management	key pad lock
Lower Limit for Cooling Operation	Schedule
Simple Timer (On/Off)	Date/time setting

Notes:  
1. Fan speed taps setting unit availability varies with the indoor unit. Please check each technical catalog in advance.  
2. Initial setting of temperature display is "Set temperature" display only. Please contact your dealer to display room temperature.

## ADVANCED WIRELESS REMOTE CONTROLLER (PC-AWR)

Transmitter

Transmitting indication  
LCD (Liquid Crystal Display)

Mode selection switch  
Reset switch

Fan speed switch  
On switch  
Off switch

Louver angle switch  
Temp. switch  
Filter reset switch

Timer switches

Outer dimensions (H×W×D) (mm) 140.0×55.0×16.8

### Functions

Run/Stop	Operation Mode	Auto Mode Setting	Temperature Setting	Temperature Setting Rate 0.5°C/1.0°C/1.0°F	Fan Speed 3/4/6 Taps	Louver Direction
Filter Sign Reset	Service	Side-by-side indoor unit identification	Schedule	Built-in Timer (On/Off)		

## WIRELESS REMOTE CONTROLLER (PC-LH7QE)

Transmitter

Transmitting indication  
LCD (Liquid Crystal Display)

Run/Stop switch

Temp. switch  
Louver angle switch

Timer switches

Reset switch

Outer dimensions (H×W×D) (mm) 140.0×52.0×19.3

### Functions

Run/Stop	Operation Mode	Auto Mode Setting	Temperature Setting	Temperature Setting Rate 1.0°C	Fan Speed 3/4/6 Taps	Louver Direction
Service	Side-by-side indoor unit identification	Schedule	Built-in Timer (On/Off)			

## RECEIVER KIT FOR WIRELESS REMOTE CONTROLLER

Model	PC-RLH11 (Basic)				PC-ALHZ1 (Advanced)				
	Ducted High ESP (AC Motor)	Ducted High ESP (DC Motor)	Ducted Medium ESP (AC Motor)	Ducted Low ESP (AC Motor)	Ducted Compact		Wall-Mounted (DC Motor)	Floor / Ceiling Convertible (AC Motor)	Floor Concealed (AC Motor)
Indoor unit	RPIH-HNAUN1Q RPI-FSNQ	RPIH-HNDUSQ	RPIH-HNAUN1Q RPI-FSN3Q	RPIL-HNAUN1Q	RPIZ-HNATN1Q	RPIZ-HNDTS1Q	RPK-HNBUSQ	RPFC-FSNQ	RPFI-FSNQ
Advanced Wireless Remote Controller PC-AWR	○	○	○	○	○	○	○	○	○
Standard Wireless Remote Controller PC-LH7QE	○	○	○	○	○	○	○	○	○
Model	HR4A10NEWQ (Basic)	PC-ALH3 (Advanced)	PC-ALHC1 (Advanced)	P-AP56NAMR (Advanced)	PC-ALHD1 (Advanced)	PC-ALHS1 (Advanced)	PC-ALHP1 (Advanced)	PC-ALHZ1 (Advanced)	
Indoor unit	4-way Cassette (DC Motor)	4-way Cassette (DC Motor)	4-way compact Cassette (AC Motor)	4-way compact Cassette (AC Motor)	2-way Cassette (DC Motor)	1-way Cassette (DC Motor)	Ceiling Suspended (DC Motor)	Wall-Mounted (DC Motor)	
Indoor unit	RCI-FSKDN1Q	RCI-FSRP	RCIM-FSRE	RCIM-FSRE	RCD-FSR	RCS-FSR	RPC-FSR	RPK-FSRM	
Advanced Wireless Remote Controller PC-AWR	○	○	○	○	○	○	○	○	
Standard Wireless Remote Controller PC-LH7QE	○	-	-	-	-	-	-	-	

(\*) Basic function receiver kit is installed as a standard part in this wall-mounted unit. Wireless remote controller (PC-LH7QE) is delivered as a standard accessory as well. If separate placement of receiver kit is required, please use optional basic receiver kit [PC-RLH11] or optional advanced receiver kit [PC-ALHZ1].

Notes:  
When using a basic receiver kit PC-RLH11 or HR4A10NEWQ together with wireless remote controller PC-LH7QE:  
1) It won't be possible to lock individual remote controllers from Hitachi Central Stations (mini/EZ/EX)  
2) It won't be possible to apply min/max restrictions on set temperature from Hitachi Central Stations (mini/EZ/EX)

**Basic**  
Limited function available for centralized controllers  
Temperature setting rate [1.0°C] only

**Advanced**  
Full function available for centralized controllers  
Temperature setting rate [0.5°C/1.0°C/1.0°F]



# Accessories



**3P CONNECTOR CABLE PCC-1A**  
FOR CONNECTION TO REMOTE ON/OFF DEVICE/RECEIPT OF OUTPUT SIGNAL

## Operation example

•Cooling operation:  
Compressor is ON by closing terminals 2 and 3 of CN3.  
Compressor is OFF by opening terminals 2 and 3 of CN3.

\*One set contains five 3P connector cables.  
\*PCC-1A can connect to external signal input-output terminal both in outdoor unit and indoor unit.

## System configuration example

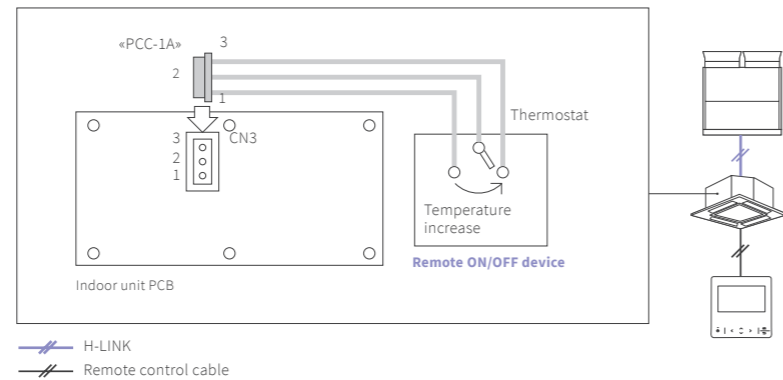

**BMS ADAPTER for BACnet® HC-A64BNP1**  
CONTROL UP TO 64 INDOOR UNITS

## Specifications

Outer dimensions (H×W×D)  
(mm) 68.0×240.0×154.0

## Functions

Corresponding BACnet® Standard	ANSI/ASHRAE Standard 135-2004 BACnet®
Control Item at Upper System	<ul style="list-style-type: none"> <li>• Run Stop (Setting)</li> <li>• Operation Mode (Setting)</li> <li>• Fan Speed Level (Setting)</li> <li>• Indoor Temperature (Setting)</li> <li>• RC Operation lock (Setting)</li> <li>• Filter Sign Reset</li> </ul>
Monitoring Item at Upper System	<ul style="list-style-type: none"> <li>• Run Stop (State)</li> <li>• Operation Mode (State)</li> <li>• Fan Speed Level (State)</li> <li>• Indoor Temperature (State)</li> <li>• Prohibiting RC Operation (State)</li> <li>• Filter Signal</li> <li>• Indoor Air Intake Temperature</li> <li>• Alarm Signal</li> <li>• Alarm Code</li> <li>• Communication State</li> </ul>

## System configuration example

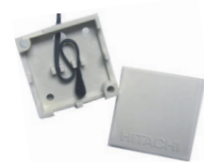
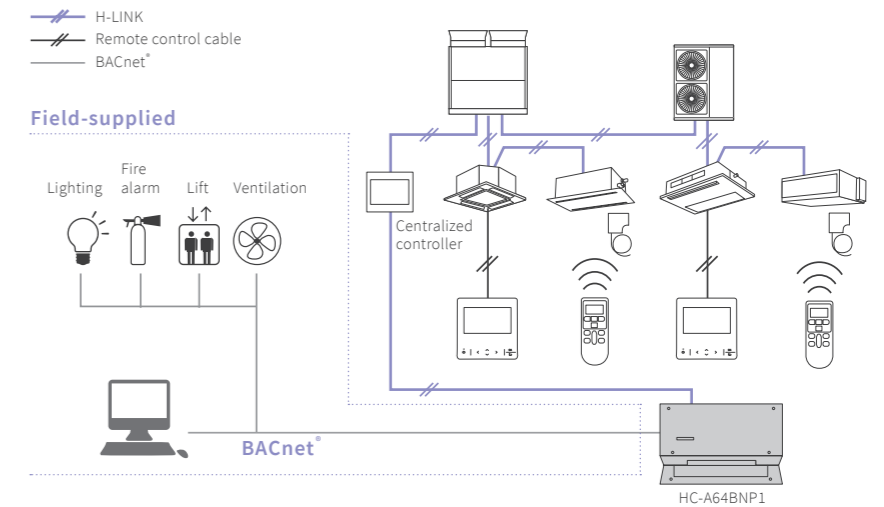

**REMOTE SENSOR THM-R2A**  
ROOM TEMPERATURE SENSOR

Outer dimensions (H×W×D)  
(mm) 50.0×50.0×15.0

Length m 8.00

## System configuration example

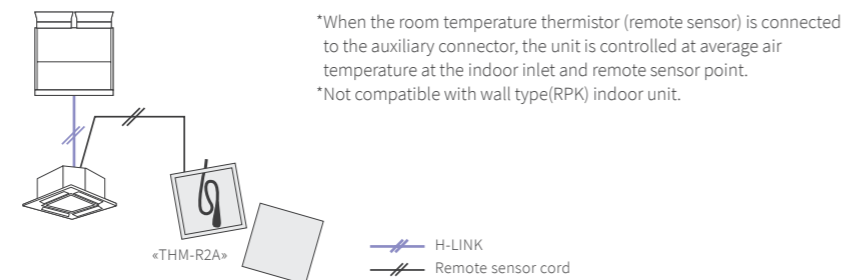

**REMOTE CONTROL CABLE PRC-5K, 10K, 15K**  
FOR PC-ARFG1 CONNECTION (TO IDU)

	PRC-5K	PRC-10K	PRC-15K
Length m	5.00	10.00	15.00

## System configuration example

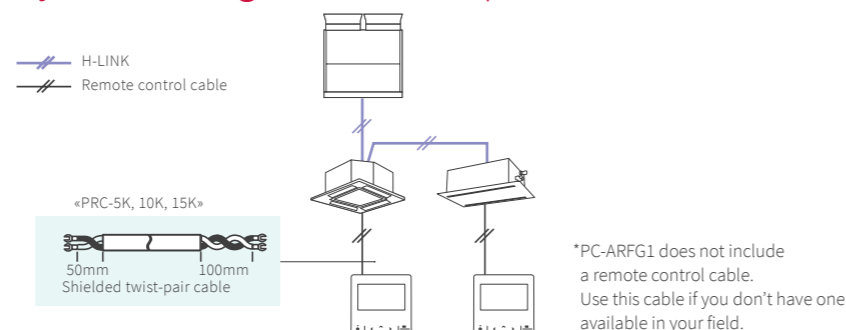

# H-LINK: enjoy more freedom

## WHAT IS H-LINK?

H-LINK is Hitachi Cooling & Heating original communication system to control multiple VRF refrigerant systems from one centralized control point.

H-LINK simplifies commissioning and service maintenance for installers and service engineers. For building owners and occupants, it provides outstanding versatility enabling the connection of various types of central control options, enabling better system management. Our proprietary high-performance communication system enables the connection of control wiring between indoor and outdoor units, and between a centralized control system and indoor/outdoor units across two or more refrigerant systems.

## Examples



Educational institutions such as primary schools where installation work cannot be performed on weekdays.



Hotels where it is preferable to complete installation work during late evenings.



Rehabilitation facilities or hospitals where it is necessary to minimize the burden on users.



## Definition of terms in Hitachi centralized control systems

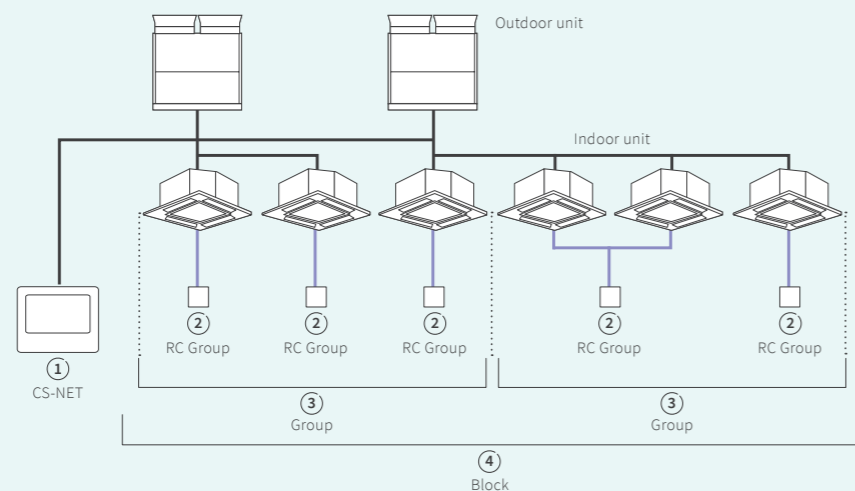

- ① CS-NET/Central station  
→ Hitachi original centralized controller.
- ② RC Group (Remote Controller System Group)  
→ Stands for a number of indoor units (up to 16 units) connected using "same remote controller" wiring. In this group, connected indoor units are all controlled in the same way.
- ③ Group  
→ Stands for the multiple "RC groups" that are registered in the centralized controller network setting.
- ④ Block  
→ Stands for the multiple "groups" that are registered in the centralized controller network setting.

## CENTRALIZED CONTROLS: FLEXIBLE WIRING ROUTE!

- (1) • Multiple refrigerant systems located in one area.
  - Central monitoring room in separate area.

### H-LINK SOLUTION

- Wire the central station to the closest indoor unit.
- Wiring distance is reduced substantially.

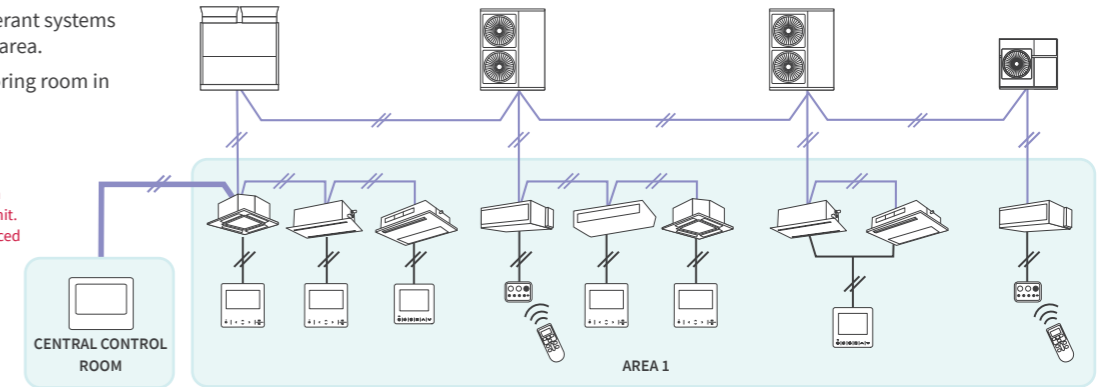

- (2) • Refrigeration systems in different places.
  - Some indoor units of each respective system are close to one another.

### H-LINK SOLUTION

- Where two indoor units of each respective system are close together: you can connect two refrigerant systems via the indoor units.
- Wiring distance is reduced substantially.

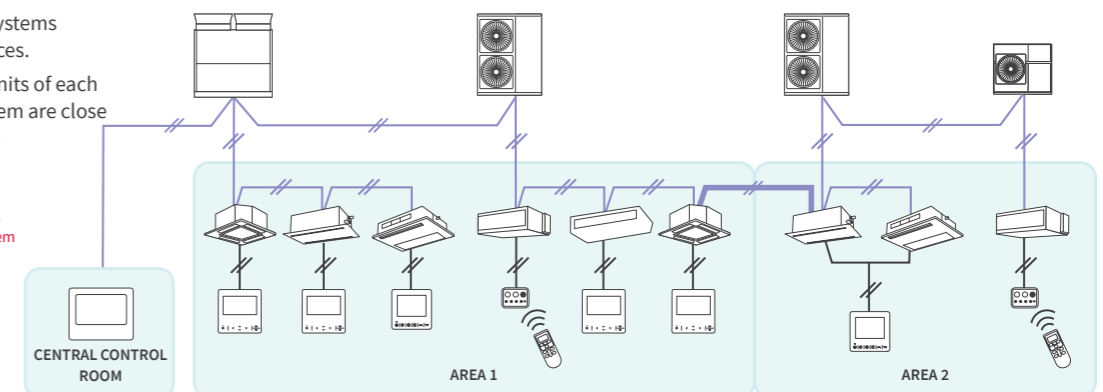

- (3) • One refrigerant system far away from the remaining ones.

### H-LINK SOLUTION

- Connect the farthest refrigerant system directly to central station either to outdoor units or indoor units.
- The central station can make the central link between the different refrigerant systems.

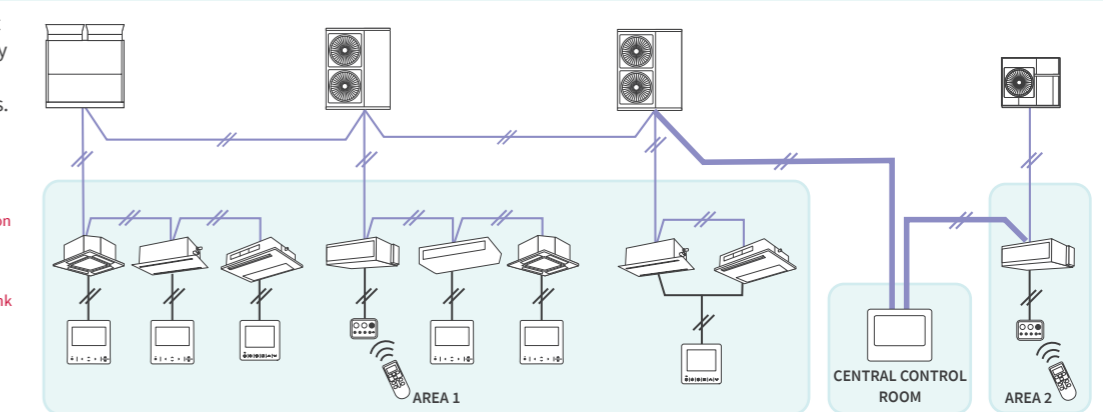

- (4) • Each refrigerant system in separate areas.
  - Indoor units are closer from one group to another.

### H-LINK SOLUTION

- Centralized control can be achieved by connecting the refrigerant systems via the closer indoor units.
- Wiring can be indoors only.

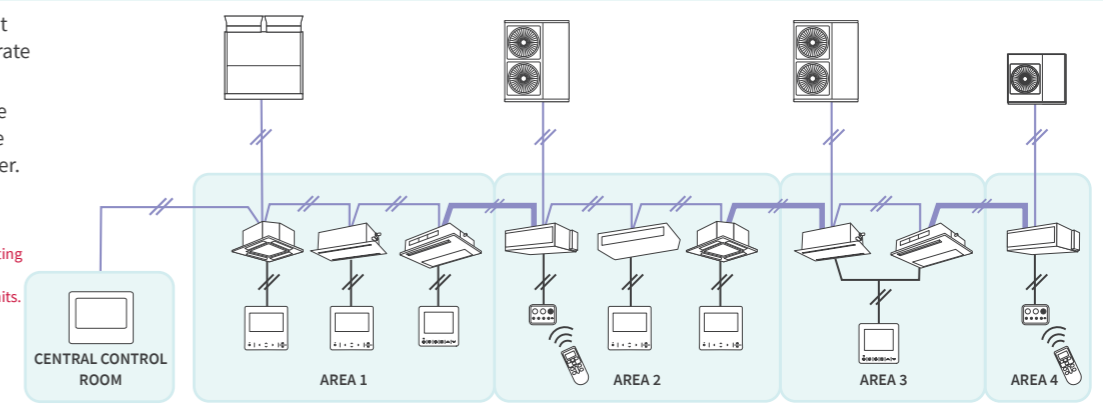

— H-LINK solution    — H-LINK    — Remote control cable