

Chiller Plant Design

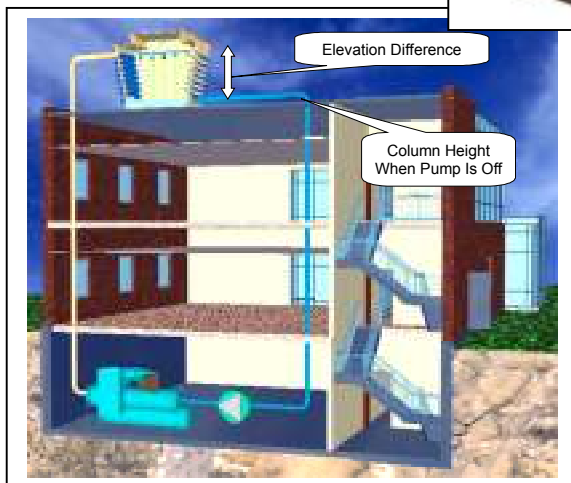
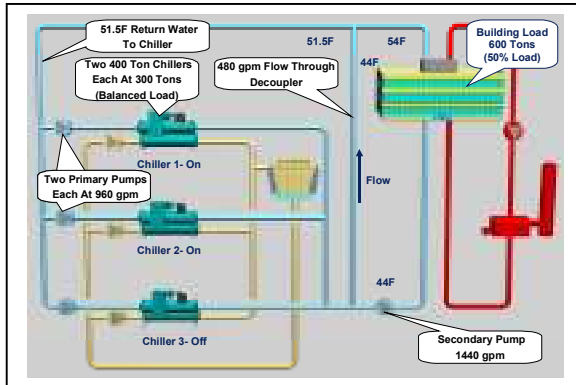

Table of Contents

Introduction	4
Using This Guide	4
Basic System	4
Chiller Basics	4
Piping Basics	7
Pumping Basics	11
Cooling Tower Basics	15
Load Basics	20
Control Valve Basics	20
Loop Control Basics	23
Piping Diversity	24
Water Temperatures and Ranges	25
Supply Air Temperature	25
Chilled Water Temperature Range	26
Condenser Water Temperature Range	26
Temperature Range Trends	27
Air and Evaporatively Cooled Chillers	28
Air-Cooled Chillers	28
Evaporatively Cooled Chillers	30
Dual Compressor and VFD Chillers	31
Dual Compressor Chillers	31
VFD Chillers	31
System Design Changes	32
Mechanical Room Safety	34
Standard 34	34
Standard 15	34
Single Chiller System	38
Basic Operation	38
Basic Components	38
Single Chiller Sequence of Operation	39
Parallel Chiller System	41
Basic Operation	41
Basic Components	41
Parallel Chiller Sequence of Operation	42
Series Chillers	44
Basic Operation	44
Basic Components	44
Series Chillers Sequence of Operation	46
Series Counterflow Chillers	47
Using VFD Chillers in Series Arrangements	49
System Comparison	49
Primary/Secondary Systems	51

Basic Operation	51
Basic Components	51
Very Large Chiller Plants.....	58
Primary/Secondary Sequence of Operation	58
Water-Side Free Cooling	61
Direct Waterside Free Cooling.....	61
Parallel Waterside Free Cooling	61
Series Waterside Free Cooling.....	62
Waterside Free Cooling Design Approach	63
Cooling Tower Sizing	63
Waterside Free Cooling Sequence of Operation	64
Economizers and Energy Efficiency	65
Hybrid Plants.....	66
Heat Recovery and Templifiers™	67
General.....	67
Load Profiles.....	67
Heat Recovery Chillers	67
Templifiers™	71
ASHRAE Standard 90.1	73
Variable Primary Flow Design	75
Basic Operation	75
Basic Components	75
Variable Primary Flow Sequence of Operation.....	76
Training and Commissioning	78
Low Delta T Syndrome	80
Low Delta T Example.....	80
Low Delta T Syndrome Causes and Solutions	82
Other Solutions	84
Process Applications	86
Process Load Profiles	86
Condenser Relief.....	87
Winter Design.....	87
Chilled Water Volume.....	87
Temperatures and Ranges	88
Minimum Chilled Water Volume	89
Estimating System Volume	89
Evaluating System Volume	89
Conclusions	92
References	93

The information contained within this document represents the opinions and suggestions of McQuay International. Equipment, the application of the equipment, and the system suggestions are offered by McQuay International as suggestions only, and McQuay International does not assume responsibility for the performance of any system as a result of these suggestions. Final responsibility for the system design and performance lies with the system engineer.

Introduction

Using chilled water to cool a building or process is efficient and flexible. A two-inch Schedule 40 pipe of chilled water can supply as much comfort cooling as 42" diameter round air duct. The use of chillers allows the design engineer to produce chilled water in a central building location or even on the roof and distribute the water economically and without the use of large duct shafts. Chilled water also provides accurate temperature control that is especially useful for variable air volume (VAV) applications.

The purpose of this manual is to discuss various piping and control strategies commonly used with chilled water systems including variable flow pumping systems.

Using This Guide

This Guide initially discusses the components used in a chilled water system. It then reviews various chiller plant designs explaining their operation, strengths and weaknesses. Where appropriate, sequence of operations are provided. Each project is unique so these sequences are just guidelines.

In addition, many sections reference ASHRAE Standard 90.1-2001. The ASHRAE section numbers are provided in parentheses to direct the reader. The sections referenced in this Guide are by no means complete. It is recommended that the reader have access to a copy of Standard 90.1 as well as the Users Manual. The Standard and manual can be purchased online at WWW.ASHRAE.org.



Basic System

Figure 1 shows a basic chiller loop with a water-cooled chiller. The system consists of a chiller, cooling tower, building cooling load, chilled water and condensing water pumps and piping. This section will review each of the components.

Figure 1 - Single Chiller Loop

Chiller Basics

The chiller can be water-cooled, air-cooled or evaporatively cooled. The compressor types typically are reciprocating, scroll, screw or centrifugal. The evaporator can be remote from the condensing

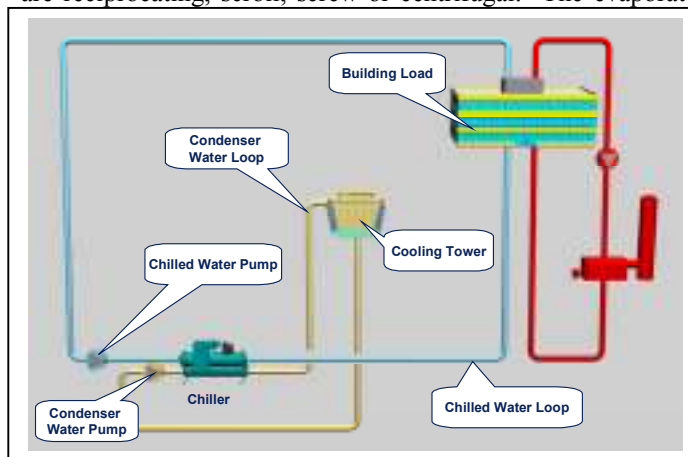

section on air-cooled units. This has the advantage of allowing the chilled water loop to remain inside the building envelope when using an outdoor chiller. In applications where freezing conditions can be expected, keeping the chilled water loop inside the building avoids the need for some form of antifreeze.

There can be multiple chillers in a chilled water plant. The details of various multiple chiller plant designs will be discussed in future sections.

The chilled water flows through the evaporator of the chiller. The evaporator is a heat exchanger where the chilled water gives up its sensible heat (the water temperature drops) and transfers the heat to the refrigerant as latent energy (the refrigerant evaporates or boils).

Flow and Capacity Calculations

For air conditioning applications, the common design conditions are 44°F supply water temperature and 2.4 gpm/ton. The temperature change in the fluid for either the condenser or the evaporator can be described using the following formula:

$$Q = W \times C \times \Delta T$$

Where

Q = Quantity of heat exchanged (Btu/hr)

W = flow rate of fluid (USgpm)

C = specific heat of fluid (Btu/lb· °F)

ΔT = temperature change of fluid (°F)

Assuming the fluid is water, the formula takes the more common form of:

$$\text{Load (Btu/hr)} = \text{Flow (USgpm)} \times (\text{°F}_{\text{in}} - \text{°F}_{\text{out}}) \times 500$$

Or

$$\text{Load (tons)} = \text{Flow (USgpm)} \times (\text{°F}_{\text{in}} - \text{°F}_{\text{out}}) / 24$$

Using this equation and the above design conditions, the temperature change in the evaporator is found to be 10°F. The water temperature entering the evaporator is then 54°F.

Most air conditioning design conditions are based on 75°F and 50% relative humidity (RH) in the occupied space. The dewpoint for air at this condition is 55.08°F. Most HVAC designs are based on cooling the air to this dewpoint to maintain the proper RH in the space. Using a 10°F approach at the cooling coil means the supply chilled water needs to be around 44°F or 45°F.

The designer is not tied to these typical design conditions. In fact, more energy efficient solutions can be found by modifying the design conditions, as the project requires.

Changing the chilled water flow rate affects a specific chiller's performance. Too low a flow rate lowers the chiller efficiency and ultimately leads to laminar flow. The minimum flow rate is typically around 3 fps (feet per second). Too high a flow rate leads to vibration, noise and tube erosion. The maximum flow rate is typically around 12 fps. The chilled water flow rate should be maintained between these limits of 3 to 12 fps.

The condenser water flows through the condenser of the chiller. The condenser is also a heat exchanger. In this case the heat absorbed from the building, plus the work of compression, leaves the refrigerant (condensing the refrigerant) and enters the condenser water (raising its temperature). The condenser has the same limitations to flow change as the evaporator.

Chillers and Energy Efficiency

Chillers are often the single largest electricity users in a building. A 1000 ton chiller has a motor rated at 700 hp. Improving the chiller performance has immediate benefit to the building operating cost. Chiller full load efficiency ratings are usually given in the form of kW/ton, COP (Coefficient of Performance = $\text{kW}_{\text{cooling}} / \text{kW}_{\text{input}}$) or EER (Energy Efficiency Ratio = $\text{Tons} \times 12 / \text{kW}_{\text{input}}$). Full load performance is either the default ARI conditions or the designer specified conditions. It is important to be specific about operating conditions since chiller performance varies significantly at different operating conditions.

Chiller part load performance can be given at designer-specified conditions or the NPLV (Non-Standard Part Load Value) can be used. The definition of NPLV is spelled out in **ARI 550/590-98, Test Standard for Chillers**. For further information refer to McQuay Application Guide **AG 31-002, Centrifugal Chiller Fundamentals**.

☺ *Tip: To convert from COP to kW/ton;
 $COP = 3.516/(kW/ton)$
 To calculate $EER = Tons \times 12/(total\ kW\ input)$*

Figure 2 - ASHRAE Std 90.1 Chiller Performance Table¹

Water Chilling Packages – Minimum Efficiency Requirements				
Equipment Type	Size Category	Subcategory or Rating Condition	Minimum Efficient	Test Procedure
Air Cooled, with Condenser, Electrically Operated	<150 tons		2.80 COP 3.05 IPLV	ARI 550/590
	≥150 tons			
Air Cooled, without Condenser, Electrically Operated	All Capacities		3.10 COP 3.45 IPLV	
Water Cooled, Electrically Operated, Positive Displacement (Reciprocating)	All Capacities		4.20 COP 5.05 IPLV	ARI 550/590
Water Cooled, Electrically Operated, Positive Displacement (Rotary Screw and Scroll)	<150 tons		4.45 COP 5.20 IPLV	ARI 550/590
	≥150 tons and <300 tons		4.90 COP 5.60 IPLV	
	≥300 tons		5.50 COP 6.15 IPLV	
Water Cooled, Electrically Operated, Centrifugal	<150 tons		5.00 COP 5.25 IPLV	ARI 550/590
	≥150 tons and <300 tons		5.55 COP 5.90 IPLV	
	≥300 tons		6.10 COP 6.40 IPLV	
Air-Cooled Absorption Single Effect	All Capacities		0.60 COP	ARI 560
Water-Cooled Absorption Single Effect	All Capacities		0.70 COP	
Absorption Double Effect, Indirect-Fired	All Capacities		1.00 COP 1.05 IPLV	
Absorption Double Effect, Direct-Fired	All Capacities		1.00 COP 1.00 IPLV	

a The chiller equipment requirements do not apply for chillers used in low-temperature applications where the design leaving fluid temperature is ≤4°F.
 b Section 12 contains a complete specification of the referenced test procedure, including the referenced year version of the test procedure.

Since buildings rarely operate at design load conditions (typically less than 2% of the time) chiller part load performance is critical to good overall chiller plant performance. Chiller full and part load efficiencies have improved significantly over the last 10 years (Chillers with NPLVs of 0.35 kW/ton are available) to the point where future chiller plant energy performance will have to come from chiller plant design.

ASHRAE Standard 90.1-2001 includes mandatory requirements for minimum chiller performance. Table 6.2.1.C of this standard covers chillers at ARI standard conditions. Tables 6.2.1H to M cover centrifugal chillers at non-standard conditions.

¹ Copyright 2001, American Society Of Heating, Air-conditioning and Refrigeration Engineers Inc., www.ashrae.org. Reprinted by permission from ASHRAE Standard 90.1-2001

Piping Basics

Static Pressure

Figure 3 - Closed Loop

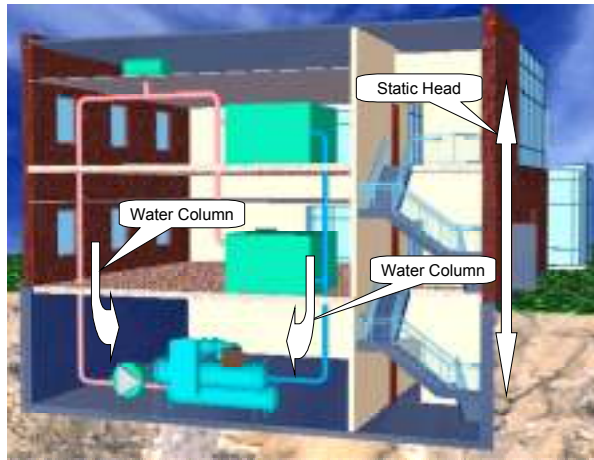

The piping is usually steel, copper or plastic. The chilled water piping is usually a closed loop. A closed loop is not open to the atmosphere. Figure 3 shows a simple closed loop with the pump at the bottom of the loop. Notice that the static pressure created by the change in elevation is equal on both sides of the pump. In a closed loop, the pump needs only to overcome the friction loss in the piping and components. The pump does not need to “lift” the water to the top of the loop.

When open cooling towers are used in condenser piping, the loop is an open type. Condenser pump must overcome

the friction of the system and “lift” the water from the sump to the top of the cooling tower. Figure 4 shows an open loop. Notice the pump need only overcome the elevation difference of the cooling tower, not the entire building.

In high-rise applications, the static pressure can become considerable and exceed the pressure rating of the piping and the components such as chillers. Although chillers can be built to higher pressure ratings (The standard is typically 150 PSI but the reader is advised to check with the manufacturer) high pressure systems can become expensive. The next standard rating is typically 300 PSI. Above that, the chillers become very expensive. One solution is to use heat exchangers to isolate the chillers from the static pressure. While this solves the pressure rating for the chiller, it introduces another device and another approach that affects supply water temperature and chiller performance. A second solution is to locate chiller plants on various floors throughout the building selected to avoid exceeding the 150 PSI chiller rating.

© *Tip: Most chillers are rated for 150 PSI water side pressure. This should be considered carefully for buildings over 10 stories.*

Figure 4 -Open Loop

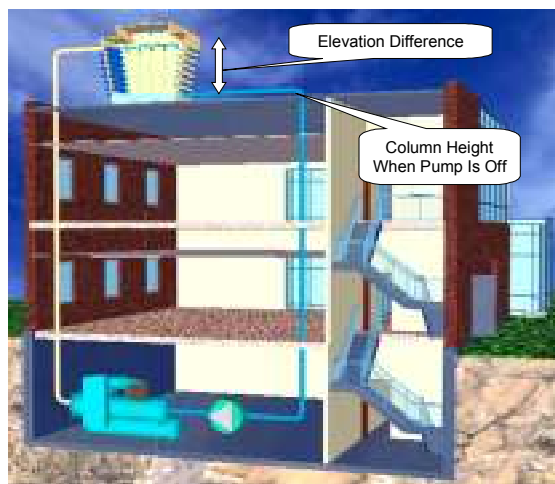

Expansion Tanks

An expansion tank is required in the chilled water loop to allow for the thermal expansion of the water. Expansion tanks can be open type, closed type with air-water interface or diaphragm type. Tank location will influence the type. Open tanks must be located above the highest point in the system (for example, the penthouse). Air-water interface and diaphragm type tanks can be located anywhere in the system. Generally, the lower the pressure in the tank, the smaller the tank needs to be. Tank size can be minimized by locating it higher in the system.

Figure 5 - Expansion Tank Location

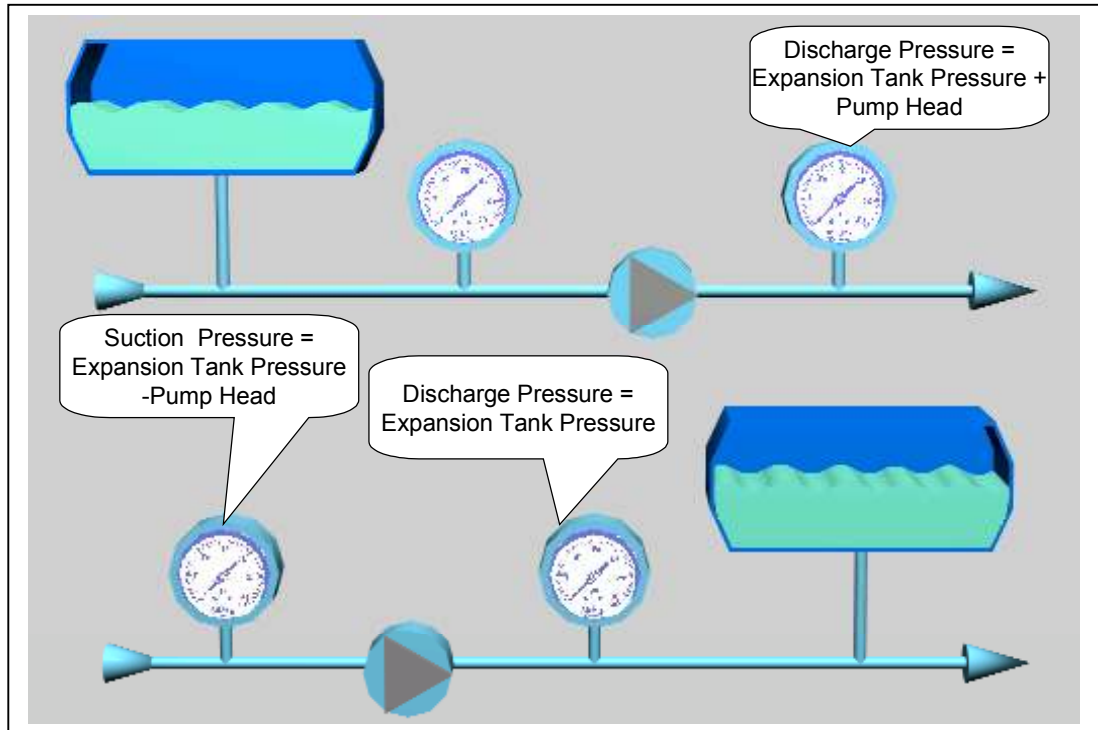

The pressure at which the tank is operated is the reference point for the entire hydronic system. The location of the tank -which side on the pump (suction or discharge) - will affect the total pressure seen by the system. When the pump is off, the tank will be exposed to the static pressure plus the pressure due to thermal expansion. If the tank is located on the suction side, when the pump is running, the total pressure seen on the discharge side will be the pressure differential, created by the pump, *added* to the expansion tank pressure. If the expansion tank is located on the discharge side of the pump, the discharge pressure will be the same as the expansion tank pressure and the suction side pressure will be the expansion tank pressure *minus* the pump pressure differential.

Piping Insulation

Chilled water piping is insulated since the water and hence the piping is often below the dewpoint temperature. Condensate would form on it and heat loss would occur. The goal of the insulation is to minimize heat loss and maintain the outer surface above the ambient air dewpoint.

Condenser Water Piping

In most cases, the condenser water piping is an open loop. Figure 4 shows an open loop with the water open to the atmosphere. When the pump is not running, the level in the supply and return piping will be even at the level of the sump. When the pump operates, it needs to overcome the friction loss in the system and “lift” the water from the sump level to the top of the loop. Condenser water piping is typically not insulated since there will be negligible heat gain or loss and sweating will not occur. If the piping is exposed to cold ambient conditions, however, it could need to be insulated and heat traced to avoid freezing.

Reverse Return/Direct Return Piping

Figure 6 - Reverse Return Piping

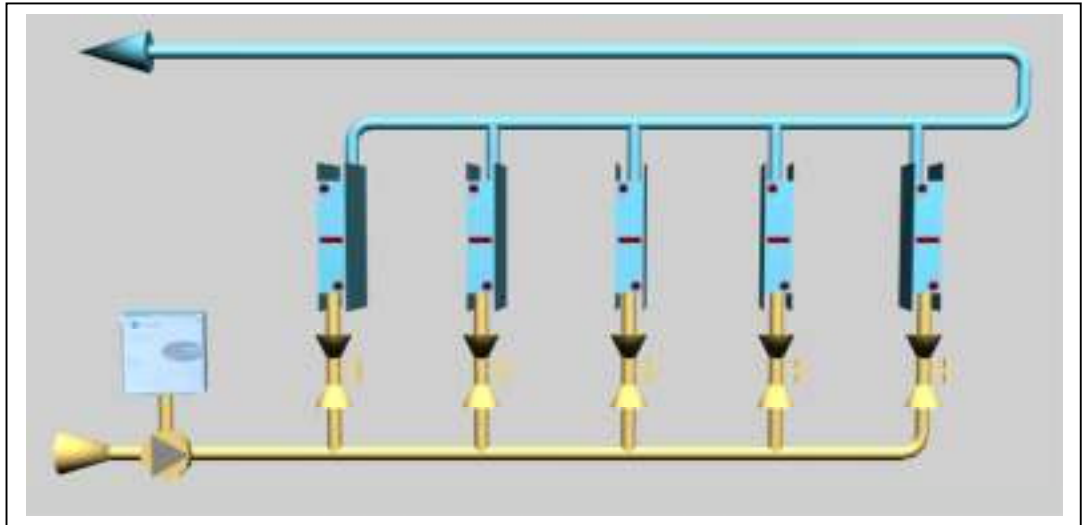
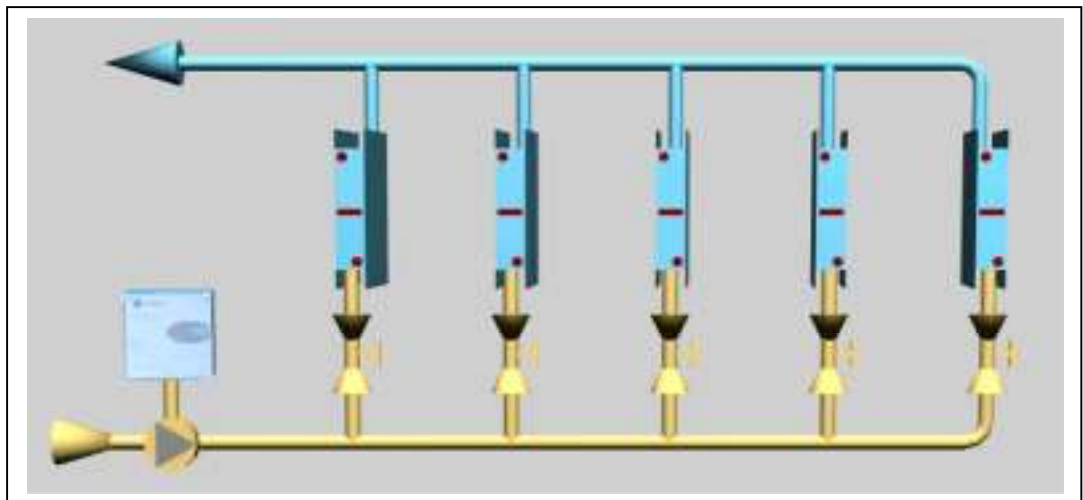

Figure 6 shows reverse return piping. Reverse return piping is designed such that the path through any load is the same length and therefore has approximately the same fluid pressure drop. Reverse return piping is inherently self-balancing. It also requires more piping and consequently is more expensive.

Figure 7 - Direct Return Piping



Direct return piping results in the load closest to the chiller plant having the shortest path and therefore the lowest fluid pressure drop. Depending on the piping design, the difference in pressure drops between a load near the chiller plant and a load at the end of the piping run can be substantial. Balancing valves will be required. The advantage of direct return piping is the cost savings of less piping.

For proper control valve selection, it is necessary to know the pressure differential between the supply and return header (refer to *Control Valve Basics*, page 20). While at first it would appear with reverse return piping, that the pressure drop would be the same for all devices, this is not certain. Changes in pipe sizing in the main headers, different lengths and fittings all lead to different pressure differentials for each device. When the device pressure drop is large relative to piping pressure losses, the difference is minimized.

In direct return piping, the pressure drops for each device vary at design conditions depending on where they are in the system. The valve closest to the pumps will see nearly the entire pump head. Valves at the furthest end of the loop will see the minimum required pressure differential. Assuming

the pressure differential sensor is located at the furthest end, all valves in a direct return system should be selected for the minimum pressure differential. This is because if any one device is the only one operating, the pressure differential controller will maintain the minimum differential across that device.

The decision whether to use direct or reverse return piping should be based on system operability vs. first cost. Where direct return piping is used, flow-balancing valves should be carefully located so that the system can be balanced.

Piping and Energy Efficiency

Piping materials and design have a large influence on the system pressure drop, which in turn affects the pump work. Many of the decisions made in the piping system design will affect the operating cost of the chiller plant every hour the plant operates for the life of the building. When viewed from this life cycle point of view, any improvements that can lower the operating pressure drop should be considered. Some areas to consider are:

- ❑ Pipe material. Different materials have different friction factors.
- ❑ Pipe sizing. Smaller piping raises the pressure drop. This must be balanced against the capital cost and considered over the lifetime of the system.
- ❑ Fittings. Minimize fittings as much as possible.
- ❑ Valves. Valves represent large pressure drops and can be costly. Isolation and balancing valves should be strategically placed.
- ❑ Direct return vs. Reverse return.

Piping insulation reduces heat gain into the chilled water. This has a compound effect. First, any cooling effect that is lost due to heat gain is additional load on the chiller plant. Second, in most cases, to account for the resultant temperature rise, the chilled water setpoint must be lowered to provide the correct supply water temperature at the load. This increases the lift on the chillers and lowers their performance.

ASHRAE 90.1-2001 requires the following for piping systems:

- ❑ Piping must be insulated as per ASHRAE Standard 90.1 Table 6.2.4.1.3. (See Table 1)

Exceptions include:

- ❑ Factory installed insulation.
- ❑ Systems operating between 60°F and 105°F.
- ❑ The hydronic system be proportionally balanced in a manner to first minimize throttling losses and then the impeller trimmed or the speed adjusted to meet the design flow conditions (6.2.5.3.3)

Exceptions include:

- ❑ Pumps with motors less than 10 hp.
- ❑ When throttling results in no greater than 5% of nameplate horsepower or 3 hp, whichever is less.
- ❑ Three pipe systems with a common return for heating and cooling are not allowed. (6.3.2.2.1)
- ❑ Two pipe changeover systems are acceptable providing: (6.3.2.2.2)
 - ❑ Controls limit changeovers based on 15°F ambient drybulb deadband.
 - ❑ System will operate in one mode for at least 4 hours.
 - ❑ Reset controls lower the changeover point to 30°F or less.
- ❑ Systems with total pump nameplate horsepower exceeding 10 hp shall be variable flow able to modulate down to 50%. (6.3.4)

Table 1 - Minimum Piping Insulation As Per Std 90.1²

Fluid Design Operating Temp. Range (°F)	Insulation Conductivity		Nominal Pipe or Tube Size (in)				
	Conductivity Btu·in/(h·ft ² ·°F)	Mean Rating Temp °F	<1	1 to <1-1/2	1-1/2 to <4	4<8	≥8
Cooling Systems (Chilled Water, Brine and Refrigerant)							
40-60	0.22-0.28	100	0.5	0.5	1.0	1.0	1.0
>60	0.22-0.28	100	0.5	1.0	1.0	1.0	1.5

Pumping Basics

Figure 8 - Inline Centrifugal Pump



Typically centrifugal type pumps are used for both condenser water and chilled water systems. They can be either inline or base mounted. The pumps must be sized to maintain the system dynamic head and the required flow rate. Normally, the pumps are located so they discharge into the chiller heat exchangers.

Figure 9 - Basic Pump Curve

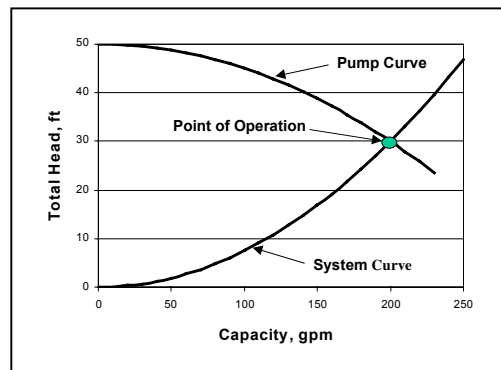

Centrifugal pumps are non-positive displacement type so the flow rate changes with the head. The actual operating point is where the system curve crosses the pump curve. In systems with control valves, the system curve changes every time a valve setting changes. This is important because the pump affinity laws cannot be used to estimate a change if the system curve is allowed to change. Identical pumps in parallel will double the flow at the same head. Identical pumps in series will double the head.

² Copyright 2001, American Society Of Heating, Air-conditioning and Refrigeration Engineers Inc., www.ashrae.org. Reprinted by permission from ASHRAE Standard 90.1-2001

Figure 10 - Pump Curve Profiles

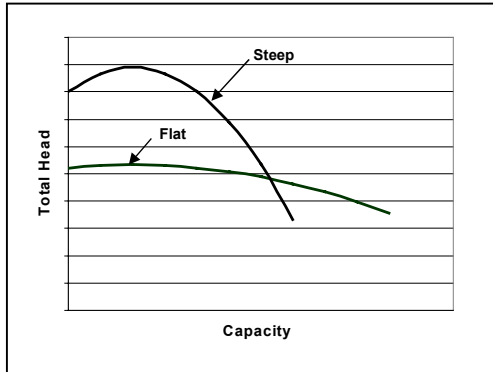

Figure 10 shows a steep and flat curve profile. Different pumps provide different profiles each with their own advantages. The steep curve is better suited for open systems such as cooling towers where high lift and stable flow are desirable. The flat profile is better suited for systems with control valves. The flat profile will maintain the necessary head over a wide flow range.

Figure 11 – Typical Centrifugal Pump Curve

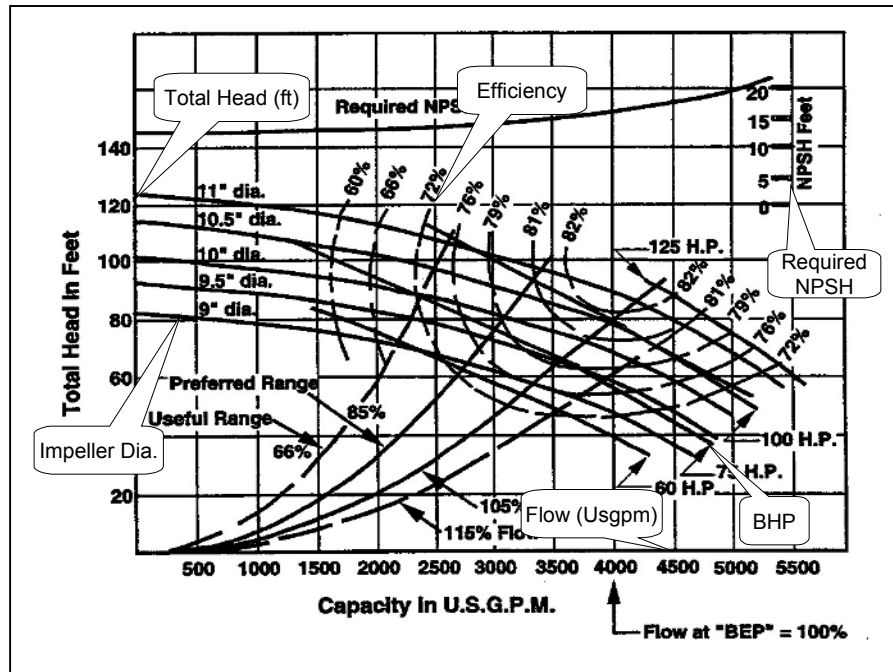

Figure 11 shows a typical pump curve. Since pumps are direct drive, the pump curves are typically for standard motor speeds (1200, 1800 or 3600 rpm). The required flowrate and head can be plotted and the subsequent efficiency and impeller diameter can be found. As the flow increases, generally the Net Positive Suction Head (NPSH) decreases. This is due to the increased fluid velocity at the inlet of the impeller. NPSH is required by the pump to avoid the fluid flashing to gas in the inlet of the impeller. This can lead to cavitation and pump damage. NPSH is an important consideration with condenser pumps particularly when the chillers are in the penthouse and the cooling towers are on the same level.

© Tip: For a constant system curve, the following pump affinity laws may be used;

At constant impeller diameter (Variable speed)
 $RPM_1 / RPM_2 = gpm_1 / gpm_2 = (H_1)^{1/2} / (H_2)^{1/2}$

At constant speed (Variable impeller diameter)
 $D_1 / D_2 = gpm_1 / gpm_2 = (H_1)^{1/2} / (H_2)^{1/2}$

Multiple Pumps

To provide redundancy, multiple pumps are used. Common approaches are (1) a complete full-sized stand-by pump, or (2) the design flow is met by two pumps with a third stand-by pump sized at half the load. When multiple pumps are used in parallel, check valves on the discharge of each pump are required to avoid “short circuiting”. Pumps can also utilize common headers to allow one pump to serve multiple duties (headered primary pumps serving multiple chillers). Refer to Primary Pumps, page 52 for more information on primary pumps.

Variable Flow Pumps

Many applications require the flow to change in response to load. Modulating the flow can be accomplished by:

- ❑ Riding the pump curve
- ❑ Staging on pumps
- ❑ Using variable frequency drives (VFDs)

Riding the pump curve is typically used on small systems with limited flow range. Staging on pumps was the traditional method until VFDs. Today, VFDs are the most common method for varying flow. They are the most efficient method as well. System flow is usually controlled by maintaining a pressure differential between the supply and return lines. The measuring point should be at or near the end of the pipe runs as opposed to being in the mechanical room to reduce unnecessary pump work. This is particularly true for direct return systems.

Figure 12 shows the differential pressure sensor located at the end of the piping run. At design load, the pressure drop across coil 1 is 60 ft while the pressure drop across coil 5 is only 30 ft. Then differential pressure

© *Tip: The differential pressure setpoint for variable flow pumps should be based on field measurements taken during commissioning and balancing. Using an estimated setting may lead to unnecessary pump work for the life of the building*

controls should be set up to maintain 30 ft. When only coil 1 is operating, the pressure differential across coil 1 will only be 30 ft if the differential sensor is located at the end of the run as shown. If the sensors had been near the pumps, however, the differential controller would have to have been set for 60 ft to meet the design requirements. When only coil 1 operates, the pressure would have been maintained at 60 ft, which would have wasted pump work.

Figure 12 - Secondary Pump Control in Direct Return Systems

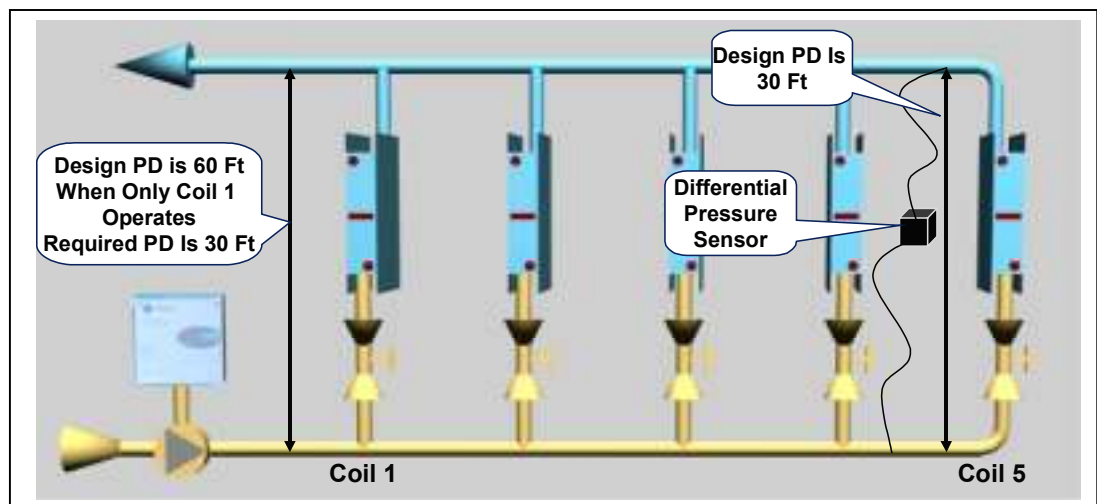

Another method of controlling variable flow pumps is to monitor the valve positions of a control valve in a critical part of the system. This valve is typically the furthest from the pumps. The control

system then maintains the minimum pressure differential necessary, which allows the valve to maintain setpoint. The advantage of this approach is the system pressure is maintained at the minimum required to operate properly and that translates into minimum pump work.

When multiple pumps are required to be variable flow, such as the secondary pumps of a primary-secondary system, VFDs are recommended on all pumps. Consider a system with two equal pumps, both are required to meet the design flow. Pump 1 has a VFD while pump 2 does not. From 0 to 50% flow, pump 1 can be used with its VFD. Above 50%, the second pump will be required. When pump 2 is started, it will operate at design speed. It will overpower pump 1, which will need to operate at less than design speed and will not generate the same head.

Figure 13 - Pumping Power vs. Flow³

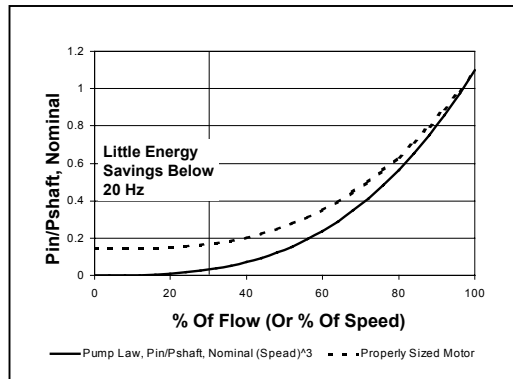
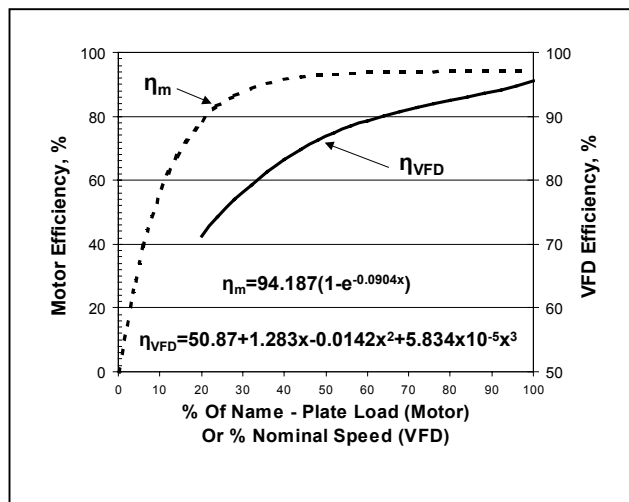

Figure 13 shows percent pumping power as a function of percent flow. From this figure, it can be seen that VFD pumps will not save much energy below 33% or 20Hz. Operating pumps much below 30% starts to create problems for motors, chiller minimum flows, etc. Since there are minimal savings anyway, the recommended minimum frequency is 20 Hz.

Pumps and Energy Efficiency

Pump work is deceptive. Although the motors tend to be small (when compared to chiller motors), they operate whenever the chiller operates. In a single water-cooled chiller plant with constant chilled water flow, it is not unusual for the pumps to use two-thirds of the energy consumed by the chiller. Optimal use of pumps can often save more energy than any other improvement to a chiller plant.

Figure 14 - Motor and VFD Efficiency At Part Load



When both motors and VFDs operate at less than 100% capacity, their efficiency drops off. Figure 14 shows motor and VFD efficiencies at part load. It can be seen that oversizing motors can lead to significantly poorer performance than expected.

Oversizing pumps themselves also leads to wasted energy. If the pumps produce too much flow, the flow will be throttled, usually with a balancing valve, to meet the desired flow. This creates an unnecessary pressure drop and consumes power all the time the pump operates. The solution in most cases, is to trim the impeller.

³ Bernier, Michel., Bernard Bourret, 1999. *Pumping Energy and Variable Speed Drives*. ASHRAE Journal, December 1999. ASHRAE. Atlanta, Ga.

ASHRAE 90.1-2001 requires the following for pumps:

- ❑ The hydronic system be proportionally balanced in a manner to first minimize throttling losses and then the impeller trimmed or the speed adjusted to meet the design flow conditions (6.2.5.3.3)

Exceptions include:

- ❑ Pumps with motors less than 10 hp.
- ❑ When throttling results in no greater than 5% of nameplate horsepower or 3 hp, whichever is less.
- ❑ Systems with total pump nameplate horsepower exceeding 10 hp shall be variable flow able to modulate down to 50%. (6.3.4)
- ❑ Individual pumps with over 100- head and a 50-hp motor shall be able to operate at 50% flow with 30% power.
- ❑ The differential pressure shall be measured at or near the furthest coil or the coil requiring the greatest pressure differential.

Exceptions include:

- ❑ Where minimum flow interferes with proper operation of the equipment (i.e., the chiller) and the total pump horsepower is less than 75.
- ❑ Systems with no more than 3 control valves.

Cooling Tower Basics

Cooling towers are used in conjunction with water-cooled chillers. Air-cooled chillers do not require cooling towers. A cooling tower rejects the heat collected from the building plus the work of compression from the chiller. There are two common forms used in the HVAC industry: induced draft and forced draft. Induced draft towers have a large propeller fan at the top of the tower (discharge end) to draw air counterflow to the water. They require much smaller fan motors for the same capacity than forced draft towers. Induced draft towers are considered to be less susceptible to recirculation, which can result in reduced performance.

Figure 15 - Induced Draft Cooling Tower



Forced draft towers have fans on the air inlet to push air either counterflow or crossflow to the movement of the water. Forward curved fans are often employed. They use more fan power than induced draft but can provide external static pressure when required. This can be important if the cooling tower requires ducting, discharge cap or other device that creates a pressure drop.

Condenser water is dispersed through the tower through trays or nozzles. The water flows over fill within the tower, which greatly increases the air-to-water

surface contact area. The water is collected into a sump, which can be integral to the tower or remote from the tower. The latter is popular in freezing climates where the condenser water can be stored indoors.

Either tower type can have single or multiple cells. The cells can be headered together on both the supply and return side with isolation valves to separate the sections. This approach allows more cells to be added as more chillers are activated or to allow more tower surface area to be used by a single chiller to reduce fan work.

Typical Operating Conditions

The Cooling Tower Institute (CTI) rates cooling towers at 78°F ambient wetbulb, 85°F supply water temperature and a 10°F range. Since it is common (but not necessary) to use a temperature range of 10°F, the cooling tower flow rate will be 3.0 gpm/ton compared to the chilled water flow rate which is 2.4 gpm/ton. The extra condenser water flow rate is required to accommodate the heat from the work of compression. Cooling towers are very versatile and can be used over a wide range of approaches, ranges, flows and wetbulb temperatures. Lower condenser water temperatures can be produced in many climates with low wet bulb temperatures which significantly improves chiller performance.

Figure 16 - Forced Draft Cooling Tower

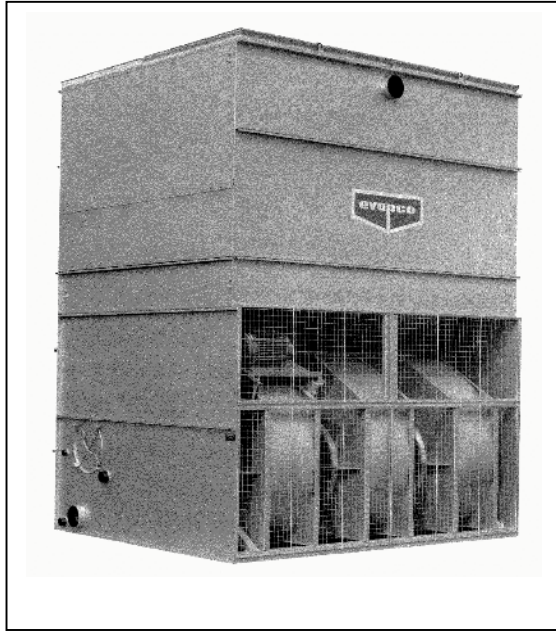

Cooling Tower Process

Cooling towers expose the condenser water directly to the ambient air in a process that resembles a waterfall. The process can cool condenser water to below ambient drybulb. The water is cooled by a combination of sensible and latent cooling. A portion of the water evaporates which provides the latent cooling. The example on page 18 shows the cooling tower process on a psychrometric chart at ARI conditions. As the wetbulb temperature drops, cooling towers rely more on sensible cooling and less on latent cooling. Ambient air below freezing can hold very little moisture which leads to large plumes; and in some cases the winter tower selection requires a larger tower than the summer conditions. Additional care should be taken when selecting cooling towers for use in winter.

Psychrometric Process for Cooling Towers

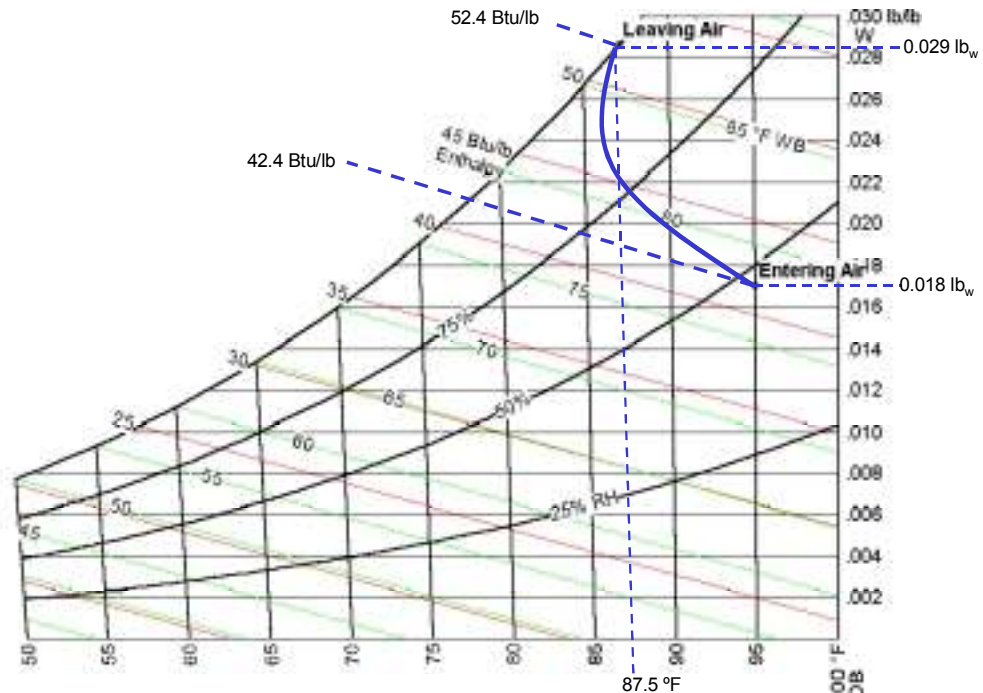

The above psychrometric chart shows the cooling tower process at ARI conditions. Assume 1 lb. of water is cooled by 1 lb. of air. The water cools from 95°F to 85°F and releases 10 Btus of heat to the air (1 Btu = the amount of heat required to raise the temperature of 1 lb. of water, 1°F). The 10 Btus of heat raises the enthalpy of air from 42.4 Btu/lb. to 52.4 Btu/lb. and saturates the air. The leaving air condition is 87.5°F and 100% RH. The moisture content went from 0.018 lb_w to 0.029 lb_w. This means 0.029-0.018 lb. = 0.011 of water was evaporated which is why it is common to hear that cooling towers lose about 1% of their water flow to evaporation. The latent heat of vaporization for water at 85°F is about 1045 Btu/lb. Multiplying the latent heat times the amount of evaporated water (1045 x 0.011) results in 11.45 Btus of cooling effect. Cooling the water required 10 Btus, the rest was used to cool the air sensibly. The air entered the tower at 95°F and left the tower at 87.5°F.

Approximately 1% of the design condenser water flow is evaporated (See the above example). A 1000-ton chiller operating at design conditions can consume 1800 gallons of water per hour. The specific amount can be calculated by reviewing the psychrometric process. In locations where the cost of water is an issue, air-cooled chillers may provide a better operating cost despite the lower chiller performance.

Winter Operation

Cooling towers required to work in freezing winter environments require additional care. The condenser water must not be allowed to freeze particularly when the tower is idle. Common solutions include electric or steam injection heaters or a remote sump within the building envelope. The high RH of ambient winter air results in a plume, which can frost over surrounding surfaces. Low plume towers are available. Finally, freezing of condenser water on the tower itself can lead to blockage and reduced or no performance. Modulating water flow through a cooling tower (such as the use of three-way chiller head pressure control) should be given careful consideration. In many instances this can lead to increased possibility of freezing the tower.

Water Treatment

Condenser water has all the right ingredients for biological growth; it is warm, exposed to air and provides surfaces to grow on. In addition, the constant water loss makes water treatment even more difficult. Both chemical and ozone-based treatment systems are used. A thorough discussion on the topic of water treatment is beyond the scope of this Guide but it suffices to say, that it is necessary to provide the proper operation of both the tower and the chiller.

Closed Circuit Coolers

Cooling towers differ from closed-circuit coolers in that closed-circuit coolers reject heat sensibly while cooling towers reject heat latently. Consider ambient design conditions of 95°F DB and 78°F wb. If closed circuit coolers are used, the condenser water must be warmer than the ambient drybulb (typically 10°F warmer or 105°F). This raises the condensing pressure in the chiller and requires more overall power for cooling. Closed circuit coolers are larger than cooling towers for the same capacity and can be difficult to locate on the roof.

Figure 17 - Chiller Power Vs. Tower Power⁴

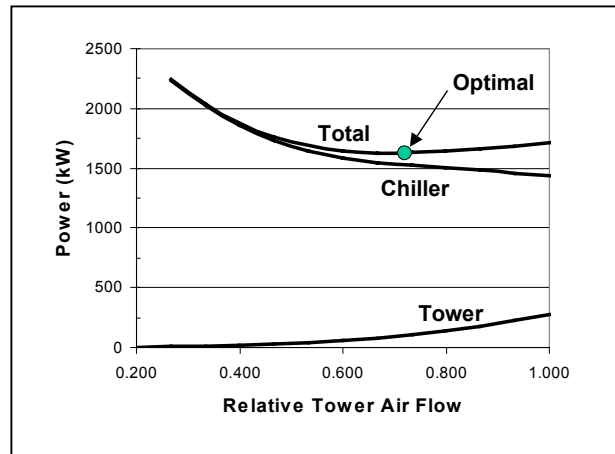

Cooling Tower Controls

Cooling tower controls provide condenser water at the correct temperature to the chillers. Defining correct water temperature is very important. Lowering the condenser supply water temperature (to the chiller) increases the effort by the cooling tower and more fan work can be expected. It also improves the chiller performance. Figure 17 shows the relationship between chiller and tower work.

Table 2 - Chiller Performance Vs. CSWT

Chiller Type	Performance Improvement (Percent kW / °F condenser water)
W/C Recip.	1.1 to 1.3
W/C Scroll	1.3 to 1.5
W/C Screw	1.6 to 1.8
W/C Centrifugal	1.0 to 1.6
W/C Centrifugal VFD	2.4 to 2.6
Absorption	1.4 to 1.5

Table 2 shows the range of chiller improvement that can be expected by lowering the condenser water supply temperature. The goal of cooling tower control is to find the balance that provides the required cooling with the least use of power by the chiller plant.

Cooling towers are often provided with aquastats. This is the most basic level of control. They are popular for single

chiller-tower arrangements because the control package can be supplied as part of the cooling tower. The aquastat is installed in the supply (to the chiller) side of the cooling tower. In many cases, the setpoint is 85°F, which is very poor.

Figure 18 shows the 85°F setpoint and the ARI condenser relief curve which chillers are rated at. Maintaining 85°F condenser water, while saving cooling tower fan work, will significantly penalize the chiller. There is some risk that without some condenser relief, the chiller may not operate at lower part load conditions (The chiller may surge).

⁴ Braun, J.E., and G.T. Diderrich. 1990. *Near-Optimal Control of Cooling Towers For Chilled Water Systems*. ASHRAE Transactions SL-90-13-3, Atlanta, Ga.

Figure 18- Chiller Performance with 85 T Setpoint

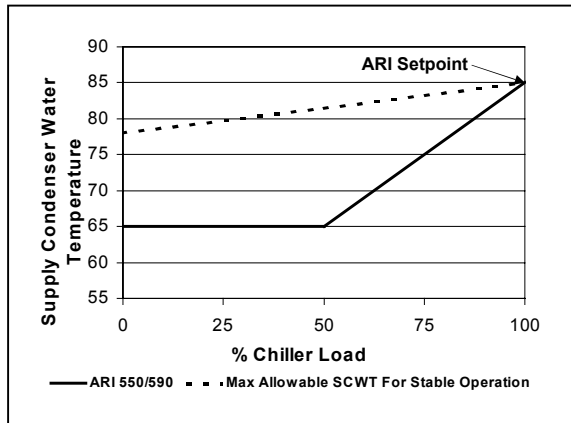

If aquastats are going to be used, then a lower setpoint than 85°F should be used. One recommendation is to set the aquastat at the minimum condenser water temperature acceptable to the chiller. The cooling tower will then operate at maximum fan power and always provide the coldest possible (based on load and ambient wet bulb) condenser water to the chiller until the minimum setpoint is reached. Then the tower fan work will stage down and maintain minimum setpoint.

Figure 19 – Chiller Performance with Minimum Setpoint

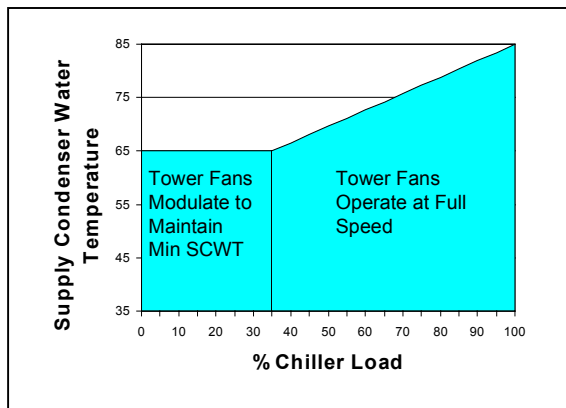

Minimum chiller setpoints are not a specific temperature. They change depending on the chiller load. A conservative number such as 65°F is recommended.

Another method to control cooling towers dedicated to single chillers is to use the chiller controller. Most chiller controllers today have standard outputs which can operate cooling towers, bypass valves and pumps. The chiller controller has the advantage of knowing just how much cooling is actually required by the chiller for optimum performance.

A method to control either single cell or multiple cell cooling towers serving multiple chillers is to base the condenser supply water temperature on ambient wetbulb. For this method, set the condenser water setpoint at the current ambient wetbulb plus the design approach temperature for the cooling tower. The set-point will change as the ambient wetbulb changes. Limit the setpoint between the design condenser water temperature (typically 85°F) and the minimum condenser water temperature (typically 65°F).

© Tip: Using wetbulb plus tower design approach as a setpoint can strike an excellent balance between chiller work and cooling tower fan work.

The wetbulb method will provide good condenser relief for the chiller and cooling tower fan work relief when the chiller is not operating at 100% capacity. It can be a good balance between chiller and tower work.

Ultimately, the best cooling tower control designs are part of a chiller plant optimization program. These programs monitor the weather, the building load and the power consumption of all the components in the chiller plant including cooling towers. Using modeling algorithms, the program calculates the best operating point to use the least power possible and meet the requirements of the building.

Cooling Towers and Energy Efficiency

Cooling towers consume power to operate the fans. Induced draft towers should be selected since they typically use half the fan horsepower force draft towers use. Some form of fan speed control is also recommended such as piggyback motors, multi-speed motors or Variable Speed Drives (VFDs). In addition, a sensible controls logic is required to take advantage of the variable speeds.

ASHRAE 90.1-2001 requires the following for heat rejection devices:

- ❑ Requires fan speed control for each fan motor 7 ½ hp or larger. The fan must be able to operate at two-thirds speed or less and have the necessary controls to automatically change the speed. (6.3.5.2)

Exceptions include:

- ❑ Condenser fans serving multiple refrigeration circuits.
- ❑ Condenser fans serving flooded condensers
- ❑ Installations in climates with greater than 7200 CDD50.
- ❑ Up to one-third of the fans on a condenser or tower with multiple fans, where the lead fans comply with the speed control requirement.

Load Basics

Figure 20 -Air Handling Equipment



Chilled water coils are used to transfer the heat from the building air to the chilled water. The coils can be located in air handling units, fan coils, induction units, etc. The air is cooled and dehumidified as it passes through the coils. The chilled water temperature rises during the process.

Cooling coil performance is not linear with flow. Cooling coils perform 75% cooling with only 50% chilled water flow and 40% cooling with only 20% flow. As well, the leaving water temperature will approach the entering air temperature as the load is reduced.

Process loads can reject heat in the chilled water in a variety of ways. A common process load is a cooling jacket in machinery such as injection molding equipment. Here the chilled water absorbs the sensible heat of the process.

Control Valve Basics

Control valves are used to maintain space temperature conditions by altering chilled water flow. Valves can be broken down into groups in several ways. Valves can be two-position or modulating. Two-position valves are either on or off. Control comes from time weighting. The percentage that the valve is open over a certain time period dictates the amount of cooling that the cooling coil actually does. Modulating valves vary the flow in response to the actual load at any given time.

Valves can also be classified as two-way or three-way type. Two-way valves throttle flow while three divert flow. Refer to *Piping Diversity*, page 24 for further explanation. There are several different physical types of valves. Globe valves, ball valves and butterfly valves are all commonly used in the HVAC industry.

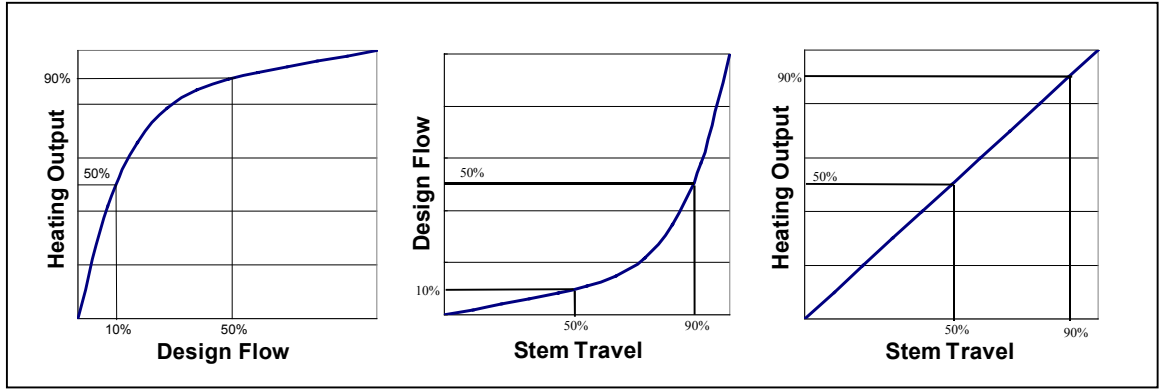

Figure 21 - Coil and Control Valve Performance Curves

Different kinds of valves have different valve characteristics. Common characteristic types include linear, equal percentage and quick opening. Control valves used with cooling coils need to have a performance characteristic that is “opposite” to the coil. Equal percentage control valves are typically used for two-way applications. For three-way applications, equal percentage is used on the terminal port and linear is used on the bypass port.

Figure 21 shows an equal percentage control valve properly matched to a cooling coil. The result is that the valve stem movement is linear with the cooling coil capacity. In other words, a valve stroked 50% will provide 50% cooling.

Sizing Control Valves

Control valves must be sized correctly for the chilled water system to operate properly. An incorrectly sized control valve cannot only mean the device it serves will not operate properly, it can also lead to system-wide problems such as low delta T syndrome.

Control valves are typically sized based on the required C_v . The C_v is the amount of 60°F water that will flow through the valve in US gpm, with a 1 PSI pressure drop. The formula is:

$$G = C_v (\Delta P)^{1/2}$$

Where:

G is the flow through the valve in US gpm

C_v is the valve coefficient.

ΔP is the differential pressure required across the control valve.

The required flow at a control valves is defined by the needs on the device (fan coil, unit ventilator or AHU) it serves. C_v values for valves are published by valve manufacturers. The required pressure differential through the valve is the difficult parameter to define.

Figure 22 - Pressure Drops and C_v

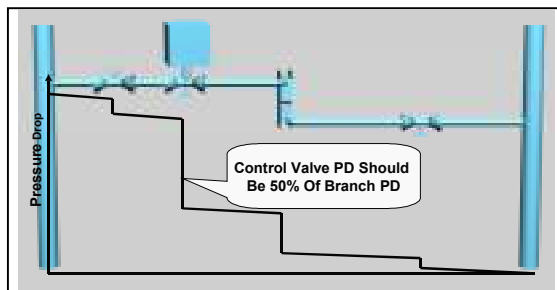

Figure 22 shows typical pressure drops from the supply to the return line for a cooling coil. For a modulating valve, the valve pressure drop should be as large a percentage as possible when compared to the system pressure drop; preferably over 50%. The reason is to maintain valve authority. For on-off control, any valve can be used as long as it can pass the required flow rate with the pressure differential available.

Valve Authority

As a control valve closes, the pressure drop across the valve increases so that when the valve is completely closed, the differential pressure drop across the valve matches the pressure drop from the supply to the return line. This pressure drop is known as ΔP_{Max} . When the valve is completely open, the pressure drop across the valve is at its lowest point and is referred to ΔP_{Min} . The ratio $(\beta) \Delta P_{Min} / \Delta P_{Max}$ is the valve authority. The increase in pressure drop across the valve as it closes is important to note. Valves are rated based on a constant pressure drop. As the pressure drop shifts, the performance of the valve changes. The method to minimize the change in valve performance is to maintain the Valve Authority (β) above 0.5.

© Tip: When calculating valve C_v to size valves, use at least 50% of the system pressure drop from the supply to the return line to maintain good valve authority. In most cases, a properly sized control valve will be smaller than the line size it is installed in.

When the valve is completely open, the pressure drop across the valve is at its lowest point and is referred to ΔP_{Min} . The ratio $(\beta) \Delta P_{Min} / \Delta P_{Max}$ is the valve authority. The increase in pressure drop across the valve as it closes is important to note. Valves are rated based on a constant pressure drop. As the pressure drop shifts, the performance of the valve changes. The method to minimize the change in valve performance is to maintain the Valve Authority (β) above 0.5.

Figure 23 - Distortion of Equal Percentage Valve Characteristic

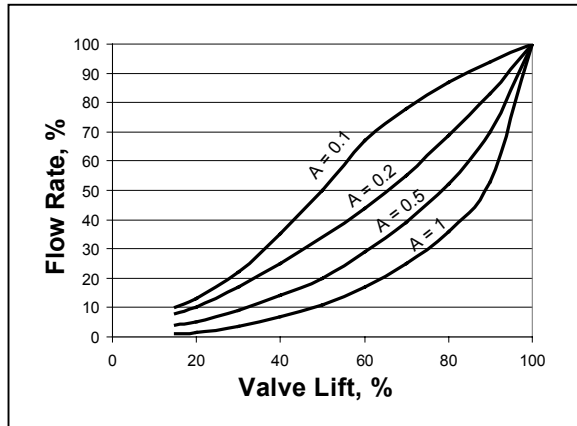

Figure 23 shows the change in the valve characteristic that occurs at different Valve Authorities. Since the goal is to provide a valve with a performance characteristic that is the opposite of a coil characteristic (See Figure 21), it is important to maintain Valve Authority above 0.5.

Valve Authority Example

Consider a control valve with a $C_v = 25$ serving a coil that has a design flow of 50 US gpm. The pressure differential from the supply to the return line is 16 PSI.

As the valve closes, the system pressure shifts to the valve until all the pressure drop (16 PSI) is across the valve. If the valve was fully opened and there was 16 PSI across the valve the flow rate would increase to:

$$Q = C_v (\Delta P)^{1/2} = 25(16)^{1/2} = 100 \text{ US gpm.}$$

This does not actually happen, however, since the pressure drop through the coil, balancing valve, etc. increases and limits flow to 50USgpm.

$$\Delta P_{Min} = (Q)^2 / (C_v)^2 = (50)^2 / (25)^2 = 4 \text{ PSI}$$

In this case, the valve authority (β) is 4 PSI/16 PSI = 0.25. Referring to Figure 23, it can be seen that the valve performance characteristic is distorted and when matched to a cooling coil will not provide a linear relationship between valve position and coil output. This can lead to poor coil performance and low delta T syndrome. The solution is to try and keep the valve authority above 0.5. In other words, the pressure drop though the control valve when it is fully open should be at least 50% of the pressure drop from the supply to return line.

Rangeability

Rangeability is a measure of the turndown a control valve can provide. The larger the range, the better the control at low loads. Typical ranges for control valves are 15:1 to 50:1.

Control Valve Location in Systems

Proper valve selection requires knowing the pressure drop from the supply to the return wherever the device is located. This information is typically not made available to the controls contractor which often leads to guessing. One solution would be for the designer to provide the required C_v for each valve. Another solution would be to provide the estimated pressure drops for each valve. Because the pressure drop from the supply to the return changes throughout the system, it can be expected that different valves with different C_v s will be required. Even if all the coil flows and pressure drops were identical, the valves should change depending on location in the system. Lack of attention to this detail can lead to low delta T syndrome (refer to *Low Delta T Syndrome*, page 80) that can be very difficult to resolve.

Loop Control Basics

There are two parameters that need to be considered for the chilled water loop. These are temperature and flow. The loop supply temperature is usually controlled at the chiller. The unit controller on the chiller will monitor and maintain the supply chilled water temperature (within its capacity range). The accuracy to which the chiller can maintain the setpoint is based on the chiller type, controller quality (a DDC controller with a PID loop is the best), compressor cycle times, the volume of fluid in the system, etc. Systems with fast changing loads (especially process loads) and small fluid volumes (close coupled) require special consideration.

The system flow control occurs at the load. To control the cooling effect at the load, two-way or three-way valves are used. Valve types are discussed in *Control Valve Basics*, page 20. Valve selection will also touch on piping diversity and variable vs. constant flow.

Another method to control cooling is face and bypass control at the air cooling coil while running chilled water through the coil. This approach has the advantage of improved dehumidification at part load and no waterside pressure drops due to control valves. The disadvantage is the requirement for continuous flow during any mechanical cooling load. In many cases the pressure drop savings will offset the continuous operation penalty but only annual energy analysis will clarify it. Face and bypass coil control is popular with unit ventilator systems with their required high percentage of outdoor air, and make-up air systems.

Piping Diversity

Figure 24 - Three-way Valves

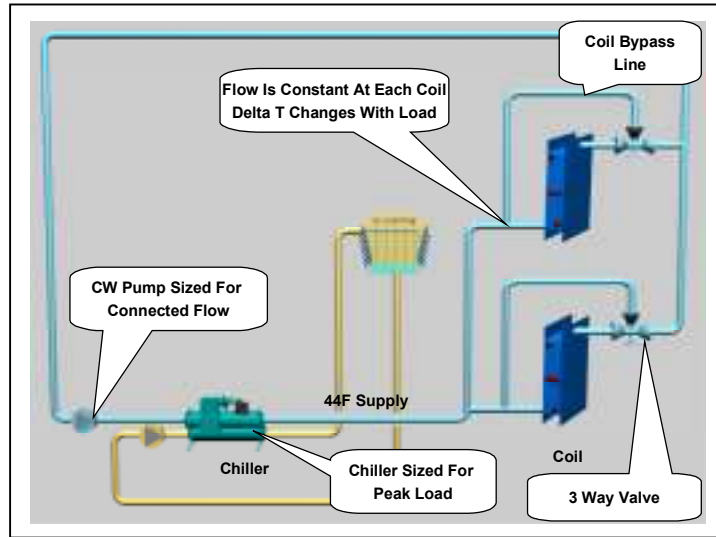

system incorporating three-way control valves is easy to design and operate. The system pumps all the water all the time, however this requires more pump horsepower. In most cases the chiller is sized for the building peak load. Due to diversity, not all the connected loads will “peak” at the same time as the building peak load. However, the pumps and piping system must be designed for full flow to all the control valves all the time. Since the chiller flow rate is the same as the flow rate through all the loads (they’re connected by the same piping system and pump) the diversity is applied to the chiller temperature range.

Diversity in piping is based on what type of valves are used. To maintain the correct space condition, three-way or two-way control valves are used. Three-way control valves direct water either through or around the coil to maintain the desired condition. If all the loads on the loop use three-way valves, then the chilled water flow is constant. The temperature range varies directly with the load. That is, if the design chilled water temperature range is 10°F, then every 10% drop in system load represents a 1°F drop in temperature range. A

Figure 25 - Two-Way Valves

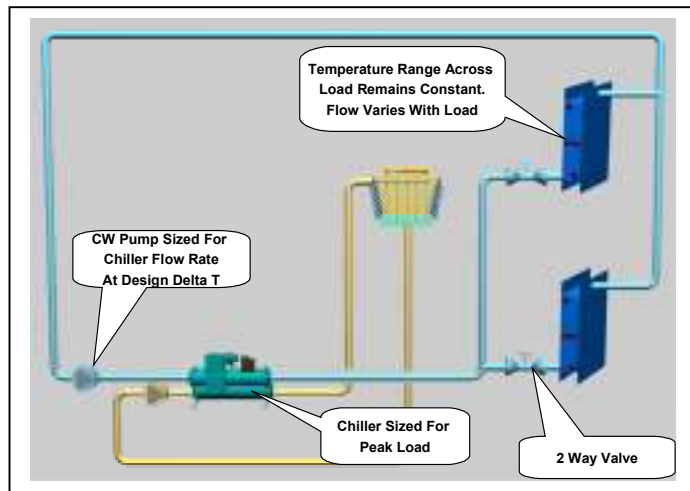

operation, but it will lower the chiller efficiency. Care must be taken to select the chiller at the proper temperature range.

When two-way modulating control valves are used, the flow to the coil is restricted rather than bypassed. If all the valves in the system are two-way type, the flow will vary with the load. If the valves are properly selected, the temperature range remains constant and the flow *varies* directly with the load. In this case the *diversity* is applied to the *chilled water flow rate*.

For example, consider a building with an 80-ton peak load. Summing all the connected loads adds up to 100 tons. In short, this building has a diversity of 80%. Using a temperature range of 10°F at each control valve, the total system flow rate is:

$$\text{Flow} = 24 \times 100 \text{ tons}/10^\circ\text{F} = 240 \text{ gpm}$$

However, an 80-ton chiller with 240 gpm will only have a temperature range of 8°F. The lower chiller temperature range is not a problem for the chiller

Using the previous example, the peak load is 80 tons and the design flow is 2.4 x 80 tons or 192 gpm. The connected load is still 100 tons and requires 240 gpm *if* all the two-way control valves are open at the same time. The 80% diversity assumes only 80% of the valves will be open at the peak load.

The advantage of two-way control valves is both the pump and the piping are sized for a smaller flow rate, offering both first cost and operating savings. The difficulty is that the chiller and control system must be designed for variable flow. The chiller has a minimum flow rate so the piping design has to allow for enough flow during all operating conditions to meet the chiller minimum flow rate. Using two-way valves is the main building block for a variable flow system.

Water Temperatures and Ranges

Selection of temperature ranges can affect the chiller plant operation and energy usage. The limiting temperatures are the required supply air temperature and either the ambient wetbulb (water or evaporatively cooled chillers) or drybulb (air cooled chillers) temperatures. Once these have been identified, the HVAC system must operate within them.

Supply Air Temperature

The chilled water supply temperature is tied to the supply air temperature. The chilled water temperature must be cold enough to provide a reasonable log mean temperature difference (LMTD) (Refer to McQuay *AG 31-002, Centrifugal Chiller Fundamentals*, for more information on LMTD) for a cooling coil to be selected. Traditionally this has resulted in a 10°F approach which, when subtracted from 55°F supply air temperature, has led to the 44 or 45°F chilled water temperature. Lowering the chilled water temperature will increase the approach allowing a smaller (in rows and fins and hence air pressure drop) coil to be used. It will also increase the lift that the chiller must overcome and that will reduce the chiller performance.

Figure 26 - Chiller Heat Exchanger Conditions

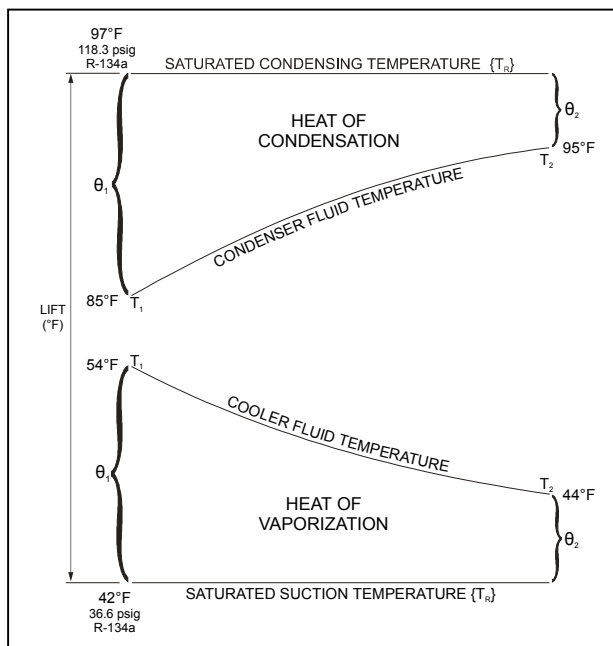

The air pressure drop savings for small changes (2 to 4°F) in the approach do not generally save enough in fan work to offset the chiller penalty. This is particularly true for VAV where the pressure drops inside an air handling unit follow the fan affinity laws. The power required to overcome the coil pressure drop decrease by the cube root as the air volume decreases. A 20% decrease in airflow results in a 36% decrease in internal air pressure drop and a 49% drop in bhp.

It is sometimes suggested that the chilled water supply temperature be 2°F colder than the supply water temperature used to select the cooling coils to make sure the “correct” water temperature is delivered to the coils. This is not recommended. For a 10°F chilled water temperature range, a 2°F temperature increase implies

20% of the chiller capacity has been lost to heat gain in the piping system! The coil would have to be selected with only an 8°F chilled water temperature range. With the exception of extremely large piping systems, there is very little temperature increase in a properly designed and installed system.

Chilled Water Temperature Range

Increasing the chilled water temperature range reduces the required flow rate and consequently the pump and piping sizes. In some situations, the savings both in capital cost and operating cost can be very large. Increasing the chilled water temperature range while maintaining the same supply water temperature actually improves the chiller performance because the chiller log mean temperature difference increases. It has just the opposite effect on the cooling coil where the LMTD decreases between the air and the chilled water. In some cases, it may be necessary to lower the supply water temperature to balance the chiller LMTD with the coil LMTD.

Table 3 - Suggested Supply Water Temperatures

Chilled Water Temperature Ranges (°F)	Suggested Supply Water Temperature (°F)
10	44
12	44
14	42
16	42
18	40

Table 3 provides suggested supply water temperatures for various ranges. The best balance of supply water temperature and range can only be found through annual energy analysis. Every project is unique. The McQuay Energy Analyzer™ can be used to quickly evaluate the pump savings vs. chiller penalty.

Products such as fan coils and unit ventilators have standardized coils designed to work with 10 to 12°F chilled water range. When these products are used with this range of chilled water, they provide the sensible heat ratio and return water temperature generally required. When the range is increased, the coils may not provide the necessary sensible heat ratio and return water temperature. It is recommended that for these products, the chilled water range stay close to industry standard conditions. Chilled water coils are designed for the application-specific conditions so this is generally not an issue.

© *Tip: Pump operating savings come from increasing the chilled water temperature range, not from lowering the supply water temperature.*

Condenser Water Temperature Range

Increasing the condenser water temperature range reduces the condenser water flow, which requires smaller pumps and piping. It also increases the required condenser pressure while improving the LMTD for the cooling tower. Increasing the condensing pressure on the chiller will result in a combination of increased chiller cost and reduced performance. Improving the cooling tower LMTD allows a smaller tower to be used, but the savings from this strategy will not generally offset the increased cost of the chiller.

In most cases, the overall design power requirement will go up. At full load conditions, the increased chiller power requirement to overcome the increased lift will more than offset the savings from the smaller cooling tower fan and condenser pump. This will depend on the head requirement of the condenser pump.

As the chilled water load decreases, the chiller and cooling tower work will reduce but the condenser pump work will remain the same. At some part load operating point, the savings from the smaller condenser pump will offset the chiller penalty and for all operating points below this, the increased condenser range will save energy. Whether an increased condenser temperature range will save energy annually will depend on when the crossover point occurs (the pump motor size) and the chiller operating profile (whether the operating hours favor the chiller or the pump). This can only be found with annual energy analysis.

Temperature Range Trends

Changing the temperature ranges and supply temperatures requires careful analysis. The following are some points to consider:

- ❑ The traditional ARI operating conditions work very well for many buildings.
- ❑ Unnecessary reduction of the chilled water supply temperature should be avoided as it increases chiller work.
- ❑ When using standard products such as fancoils and unit ventilators, maintain the chilled water temperature range between 10 and 12°F where they are designed to operate.
- ❑ Increasing the chilled water temperature range is a good way to reduce the capital and operating cost of a building, particularly if the pump head is large or the piping runs long.
- ❑ With larger chilled water temperature ranges it may be necessary to lower the supply water temperature to find a balance between coil and fan performance vs. chiller performance. Annual energy analysis using the McQuay Energy Analyzer™ is recommended.
- ❑ If the chilled water supply temperature is reduced, consider oversizing the cooling tower to reduce the condenser water temperature and minimize the affect on the chiller.
- ❑ Always take into account the actual design ambient drybulb or wetbulb conditions when designing a chiller plant. If the location is arid, then lower the wetbulb design as per ASHRAE design weather data and select both the cooling tower and chiller accordingly.
- ❑ For very large chilled water ranges, use series chillers possibly with series counterflow condenser circuits to optimize chiller performance.
- ❑ Increasing the condenser water range should only be considered for projects where the piping runs are long and the pump work high. When it is required, optimize the flow to the actual pipe size that is selected and select the chillers accordingly. Consider oversizing the cooling towers to minimize the affect on the chiller.
- ❑ Use the McQuay Energy Analyzer™ to evaluate various temperature range supply water temperature combinations. Design condition performance is not an accurate indicator of the annual energy usage.

Air and Evaporatively Cooled Chillers

The choice of chiller type and chiller plant design are inherently linked. Different chiller types have different strengths and by careful selection of chiller plant design, these strengths can be optimized. Most large plants consist of centrifugal water cooled chillers. Hybrid plants (discussed in *Hybrid Plants*, page 66) may also include absorption chillers.

Air-Cooled Chillers

Figure 27 - McQuay Air-Cooled Screw Chiller



Many small to medium chiller plants use air cooled chillers with air-cooled screw chillers being common in the 150 to 400-ton range. Air-cooled screw chillers offer very good performance particularly at part load. The compressors are modulating rather than stepped which provides more accurate control.

Air cooled chillers avoid the need for cooling towers, condenser pumps and condenser piping which can offer substantial capital savings. Air cooled chillers do not require mechanical room space which offers additional savings.

Another advantage of air-cooled chillers is they do not consume water like water-cooled chillers. A 400-ton chiller will consume over 700 gallons per hour to offset cooling tower makeup. Where water is scarce, this can be a significant cost. In addition, condenser water treatment is avoided.

© Tip: Air cooled chillers do not require mechanical room space. To estimate the savings use \$50/ft².

Drybulb Relief

Air-cooled chillers have lower performance (consume more power) than water or evaporatively cooled chillers because of the increased lift. Refrigeration work is proportional to lift; doubling the lift will approximately double the work required. (For this purpose, consider lift to be the difference between chilled water supply and either cooling tower supply or ambient air drybulb) Since air-cooled chillers must raise the refrigerant temperature above ambient drybulb, they consume more power.

© Tip: When considering air cooled vs. water cooled it is important to make an apples-to-apples comparison. Air-cooled chillers are rated with the condenser fans included. To be fair, water-cooled chillers should have the condenser pump and the cooling tower fans added. For instance, a water-cooled chiller with 0.55 kW/ton performance changes to 0.64 kW/ton when the condenser pumps and tower fan motor are

Both chiller types will improve chiller performance when the lift is reduced. This is often referred to as condenser relief. Figure 28 shows the annual drybulb vs. wetbulb temperature for Chicago. The curves show the amount of available condenser relief for each type of chiller. As expected, the wetbulb based (water-cooled) chillers offer the best performance at design conditions, however, the relief during spring and fall seasons quickly reduces the difference. In the winter, there is no advantage, as either system will operate at the minimum condensing temperature permissible by the refrigeration system.

Understanding the overall annual performance is important when considering the building use. For example, schools are rarely operating at design conditions during the summer months due to reduced occupancy. This has the effect of limiting the advantage water-cooled chillers have over air-cooled chillers.

Figure 28 - Annual Ambient Drybulb Vs. Wetbulb

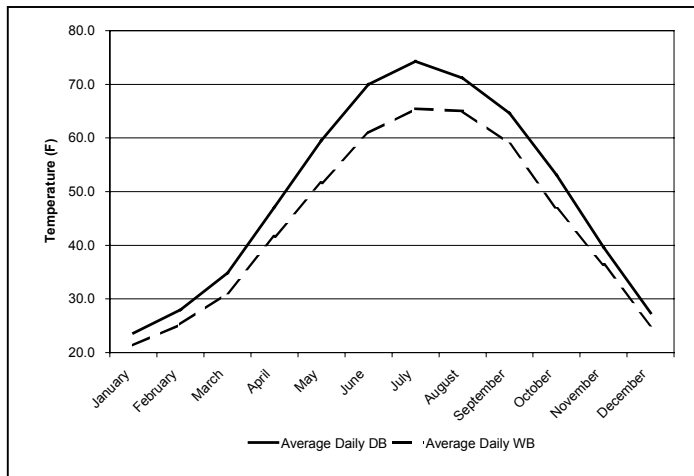

Water-cooled chiller systems usually out perform air cooled chiller systems. However, when considering life cycle analysis, the payback for water-cooled systems can be very long.

Winter Operation

In climates where freezing conditions exist, winter operation must be considered. There are two issues to deal with. The first is the necessary changes to the chiller to operate in cold temperatures. All chillers have a

minimum condensing temperature. Going beyond that temperature may damage the chiller. To protect the chiller, the condensing fans are staged off, or slowed down to maintain the correct condensing temperature. In very cold climates, a flooded system may be required. There are other changes that are required as well, such as larger crankcase heaters. Consult your sales representative to discuss these requirements.

The second issue is protecting the chilled water from freezing. Here are some possible solutions:

- ❑ Heat trace the piping and evaporator. This is a good solution where freezing weather occurs but is not extensive. It is also a good backup for systems that are to be drained in the winter. Many chillers already include evaporator tracing. Check with your sales representative.
- ❑ Add antifreeze. A common solution is to add either propylene or ethylene glycol to the chilled water. While this will resolve the freezing issue, it will increase pumping work and de-rate both the chiller and chilled water coils. Maintaining the correct level of antifreeze in the system becomes an additional maintenance issue. A loss of antifreeze in the system due to flushing or a leak and subsequent water make-up can allow the chilled water loop to become vulnerable to freezing. Adding glycol to a system that was not designed to have it must be carefully examined to ensure the system will operate properly.
- ❑ Relocate the evaporator barrel inside the building envelope. Relocating the evaporator avoids antifreeze but will require field refrigerant piping. There are also limitations on piping distances and elevation changes. Consult your sales representative to discuss the details.
- ❑ Use an indoor chiller with a remote air-cooled condenser. This arrangement will require mechanical room space, however, the equipment can be serviced from within the building. This is a very good solution for very cold climates. The compressors are indoors and flooded condensers can easily be added.

Air-Cooled Chiller System Design

Air-cooled chillers will affect the system selection and design details. In most cases, air-cooled chillers are limited in evaporator shell arrangements when compared to centrifugal chillers. They are designed to work well around the ARI 550/560 design conditions (54°F EWT, 44°F EWT). The design temperature range should stay within 20% of these operating conditions. Series chiller arrangements will typically double the flow and half the temperature change in the evaporator. This

can lead to very high water pressure drops. Contact your sales representative to review the acceptable performance ranges of the various chiller options.

Air-cooled chillers can be used in any chiller system design. They are commonly used in single, parallel and primary/secondary systems. They can be mixed with water cooled chillers in multiple chiller applications.

Most air-cooled chillers can be used in either constant or variable flow applications. Variable flow in the evaporator is a function of the staging and chiller controller. Check with your sales representative when designing variable primary flow systems.

There are many applications that require a small amount of chilled water during the winter. For example, a hospital might require chilled water to cool an MRI year-round while the AHUs can switch to air-side economizers in the winter. When there is a requirement for small amounts of chilled water in winter, an air-cooled chiller is an excellent solution. An air-cooled chiller avoids the need to operate a cooling tower in cold (freezing) weather. In addition, the air-cooled chiller will offer equal performance to a water-cooled chiller at low ambient conditions.

Evaporatively Cooled Chillers

Evaporatively-cooled chillers are essentially water-cooled chillers in a box. The hot gaseous refrigerant is condensed by water flowing over the condenser tubes and evaporating. This ties the condensing temperature to ambient wetbulb like a water-cooled chiller. The condenser, water sump and pump, etc., are all integral to the chiller. Whereas a water-cooled chiller will require a cooling tower, condenser pump and field erected piping, the evaporatively-cooled chilled comes as a complete package from the factory. Evaporatively-cooled chillers offer the ease and savings of air-cooled chiller installation while providing performance comparable to water-cooled chillers. Evaporatively-cooled chillers will require makeup water, water treatment and drains.

© *Tip: Evaporatively -cooled chillers are not just for hot, dry climates, should be considered wherever water-cooled chillers make sense.*

Figure 29 - McQuay EGR Evaporatively Cooled Chiller



Evaporatively-cooled chillers are often associated with hot, dry climates such as the American Southwest. However, they should be considered wherever water-cooled chillers make sense.

Evaporatively Cooled Chiller System Design

Evaporatively-cooled chillers can be used in any system design. They have similar limitations as air-cooled chillers (Refer to *Air-Cooled Chiller System Design*, page 29).

Dual Compressor and VFD Chillers

The unique performance of both McQuay dual compressor and variable frequency drive chillers affect the chiller plant design. While it is satisfactory to simply switch conventional chillers with either dual or VFD chillers in the chiller plant, to take full advantage of these chillers capabilities, the design should be modified.

Dual Compressor Chillers

Figure 30 - McQuay Dual Compressor Chiller

McQuay dual compressor centrifugal chillers offer many advantages over conventional chillers. From a performance point of view, the chiller is most efficient at 50% capacity. At this point, only one compressor is operating and the evaporator and condenser are twice the size normally used for the compressor size. Whereas a conventional chiller NPLV can be 0.479 kW/ton, a dual NPLV is 0.435 kW/ton. An advantage a dual compressor chiller offers over a



VFD chiller is it does not require significant condenser water temperature relief to provide the savings. Dual chillers can also have VFD offering the best of both worlds with an NPLV of 0.360 kW/ton or lower.

The built-in redundancy of a dual compressor chiller allows the designer to use fewer chillers and still provide the owner with backup equipment. This can save considerable capital expense in installation costs.

VFD Chillers

Figure 31 - VFD Chiller

VFD chillers use a combination of VFDs and inlet guide vanes to modulate the capacity of the chiller. The VFD is used to change the speed of the compressor. For information on how this works, refer to McQuay *AG 31-002, Centrifugal Chiller Fundamentals*. The performance savings are obtained when the VFD is used rather than the inlet guide vanes. Typical VFD chiller NPLV is about 0.386 kW/ton. The VFD can only be used when the lift on the compressor is reduced. The lift is reduced either when the chiller load is decreased or when the condenser water temperature is lowered and/or the chilled water temperature is raised. When the lift is reduced and the VFD can be used, the chiller will operate much more efficiently at part load than a conventional chiller does.



The best way to take advantage of a VFD chiller is to reduce the condenser water temperature as much as possible. Climates with reasonable annual changes in wetbulb are prime candidates for VFD chillers.

System Design Changes

Conventional Application

Both dual compressor and VFD chillers operate much more efficiently at part load. Conventional chillers operate most efficiently at or near full load. To fully optimize a dual or VFD chiller, the design should take advantage of their part load performance.

Figure 32 - Chiller Performance Vs. Plant Load

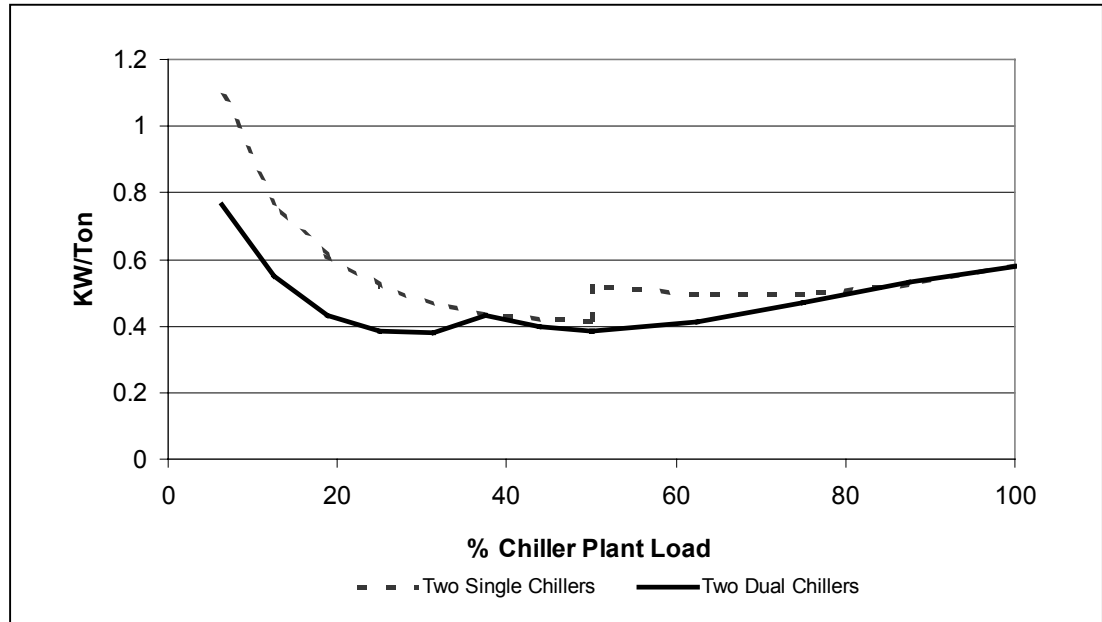

Figure 32 is based on two equally sized chillers in a primary/secondary arrangement using the ARI condenser relief profile for the entire plant. At the 50% load point, the second chiller must be started. For conventional chillers, the chiller performance drops because the load is split evenly between the two chillers and they unload to a less efficient operating point. The dual and VFD chillers actually improve their performance because the chillers are unloaded and there is condenser relief available.

Considering that most buildings experience a significant number of operating hours around 50% plant load, the dual or VFD chillers may offer appreciable savings even when used in a convention manner.

Lead Chiller Application

The first chiller that is activated in a plant, typically called the lead chiller, operates with many hours at reduced load and condenser water temperature. An example is a multi-chiller primary /secondary plant. The lead chiller sees optimal conditions for either a VFD or a dual compressor chiller. The other chillers in the plant can be conventional chillers. Each chiller that is started as the plant load increases will operate at a higher percent load with less condenser water relief and therefore will offer fewer savings.

Winter Load Application

Another good application for a dual or VFD chiller is winter load applications. Building using fancoils have considerable chiller plant loads even in winter. Other buildings such as hospitals or office buildings with computer, telecommunications or other winter chilled water loads can also take

advantage of a dual or VFD chiller. In many cases, these winter loads are relatively small. Conventional thinking would require a smaller chiller sized specifically for the load. With a dual or VFD chiller, there may not be a performance penalty to use a larger chiller sized for summer loads to handle the small winter load. The peripheral loads such as pumps should be checked when evaluating performance.

Series Chiller Application

A common method for sizing chillers used in series is to select both chillers to be able to perform as the lead chiller (See *Series Chillers*, page 44). This causes the lag chiller to be sub-optimized because the lift is reduced in the lag position. By using a VFD chiller as the upstream chiller, the VFD can take advantage of the reduced lift when operating as the lag chiller. In addition, the same chiller can be used as the lead chiller during light loads when there should be condenser water relief available.

Asymmetrical Chiller Application

Selecting the chillers to be different sizes can improve chiller plant performance based on the building load profile (see *Varying Chiller Sizes*, page 57). Using either a dual or VFD chiller for that larger chiller can enhance the savings. Consider a 1200-ton plant consisting of an 800-ton dual compressor and a 400-ton single compressor chiller. The dual compressor chiller can accommodate the plant load up to 800 tons. Above that, the second chiller must be started and both chillers will initially operate at 67%. The larger chiller will be more efficient when unloaded.

Low Delta T Application

Most variable flow chiller plants will see a drop in return water temperature as the load drops. The low delta T can cause serious operation issues with the plant (See *Low Delta T Syndrome*, page 80). One solution is to use either dual or VFD chillers and operate two chillers at part load as opposed to one chiller fully loaded. The dual or VFD chillers partly loaded should be more efficient than one conventional chiller fully loaded. The chiller savings can be used to offset the additional pumping cost from operating peripheral pumps. Moreover, this arrangement will provide the necessary chilled water flow on the primary side to offset the low delta T problem.

Total System Analysis

When estimating the savings, consider both the type of chillers used and the available lift reduction (condenser relief) and peripheral equipment that must be operated. Many combinations of plant design can be quickly modeled using the McQuay Energy Analyzer™.

Mechanical Room Safety

Chillers represent large, powerful machines filled with refrigerants. When chillers are placed in confined spaces, care must be exercised to provide safety to the equipment operator and the public at large.

ASHRAE Standard 15-2001, *Safety Standard for Refrigeration Systems* and ASHRAE Standard 34-2001, *Designation and Safety Classification of Refrigerants*, provides the designer with excellent sources when designing a chiller mechanical room. In Canada, CSA –B52, provides similar information.

The following is a brief summary of the safety requirements covered by these documents as they apply to chiller mechanical rooms. This section is by no means a complete review of all requirements covered by these standards. It is recommended that the design have access to these documents. ASHRAE plans to publish a users manual for Standard 15, which may also be very helpful.

Standard 34

Standard 34 lists refrigerants and provides a safety classification as shown in Figure 34. Refer to Standard 34 or to McQuay Application Guide *AG 31-007, Refrigerants* for further information on common refrigerants and their safety properties.

Figure 33 - ASHRAE STD 15-2001

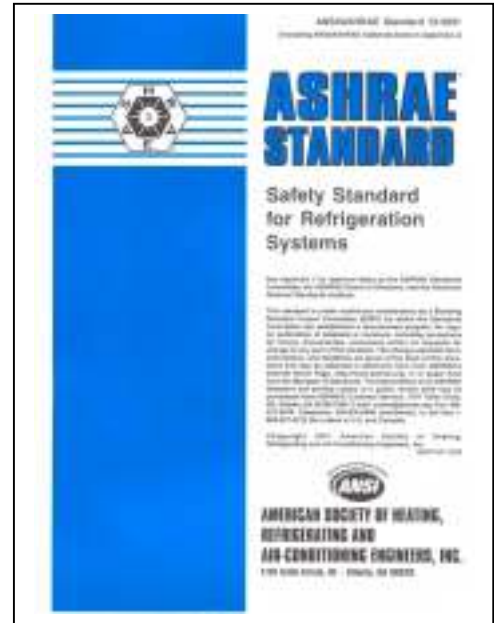

Figure 34 - ASHRAE STD 34 Safety Classification⁵

Standard 15

The purpose of Standard 15 is to specify “safe design, construction, installation, and operation of refrigeration systems⁶.” The following is a brief outline of the issues that affect chiller mechanical room design. The Section numbers refer to ASHRAE Standard 15 sections.

	Lower Toxicity	Higher Toxicity
Higher Flammability	A3	B3
Lower Flammability	A2	B2
No Flame Propagation	A1	B1

⁵ ASHRAE, 2001. *ANSI/ASHRAE Standard 34-2001, Designation and Safety Classification of Refrigerants*. Atlanta, Ga.: ASHRAE

⁶ ASHRAE, 2001. *ANSI/ASHRAE Standard 15-2001, Safety Standard for Refrigeration Systems*. Atlanta, Ga.: ASHRAE

Occupancy Classification

(Section 4)

Standard 15 identifies seven occupancy types (4.1.1 to 4.1.7) that consider the ability of the occupants to respond to a potential exposure to refrigerant. An example is Institutional Occupancy where it is anticipated that the occupants may be disabled and not capable of readily leaving the building without assistance. A hospital is an institutional building.

Refrigeration System Classification (Section 5)

Section 5 describes various types of refrigeration systems based on how they extract or deliver heat. Chiller plants are considered *indirect* systems because they cool chilled water, which in turn cools the air. Indirect systems are subsequently subdivided by how the secondary fluid (chilled water) contacts the air stream. Assuming coils are used, the classification is *indirect closed system* (5.1.2.3). If open spray coil systems are used then the classification becomes either *indirect open spray system* (5.1.2.1) or *double indirect spray system* (5.1.2.2).

The refrigeration system classification is used to determine the probability that a refrigeration leak would enter the occupied space. Indirect closed systems such as chiller plants are generally considered *Low-Probability* systems (5.2.2) providing they are either outside the building or in a mechanical room.

Refrigeration Safety Classification (Section 6)

Standard 15 uses the safety classifications listed in Standard 34. Table 4 of this Guide is based on Table 1 in Standard 15. It shows the group, refrigerant name, formula and the minimum quantity of refrigerant allowed in an occupied area. Blends such as R-407C and R-410a are classified based on the worst case fractionation of the refrigerant.

Table 4 - STD 15 Refrigerants and Amounts⁷

Refrigerant Number	Chemical Name	Chemical Formula	Quantity of Refrigerant per Occupied Space	
			Lb./1000 ft ³	PPM (Volume)
Group A1				
R-11	Trichlorofluoromethane	CCl ₃ F	1.6	4,000
R-12	Dichlorodifluoromethane	CCl ₂ F ₂	12	40,000
R-22	Chlorodifluoromethane	CHClF ₂	9.4	42,000
R-134a	1,1,1,2-Tetrafluoroethane	CH ₂ FCF ₃	16	60,000
Group B1				
R-123	2,2-Dichloro-1,1,1-Trifluoroethane	CHCl ₂ CF ₃	0.40	1,000

Restrictions on Refrigeration Use (Section 7)

Section 7 describes the restrictions on where refrigerants can be used. It is based on results of Sections 4, 5 and 6. With high probability systems (the refrigerant can enter the occupied space i.e. a spot cooler) the maximum refrigerant level is defined in Table 1 of Standard 15 (7.2). For example R-123 can only have a concentration of 0.4 lb per 1000 ft³ occupied space. Once these levels are exceeded, the refrigeration equipment must be either outdoors or in a mechanical room (7.4). Refrigerant levels involved in chiller plants necessitate mechanical rooms or outdoor equipment.

An interesting issue occurs when an air handling unit that serves occupied spaces is in the chiller mechanical room. If a leak occurs, the refrigerant may be drawn into the air handling unit and circulated through the building. The best solution to this is to avoid air handling units in the chiller

⁷ ASHRAE, 2001. *ANSI/ASHRAE Standard 15-2001, Safety Standard for Refrigeration Systems*. Atlanta, Ga.: ASHRAE

mechanical room. This may not be possible in existing buildings. Standard 15 does allow AHUs in the chiller mechanical room if they are sealed (8.11.7).

Installation Restrictions (Section 8)

Section 8 describes the installation requirements. It has general requirements (8.1 through 8.10) and then requirements for nonflammable (type A1 and B1) refrigerants (8.11). Flammable refrigerants are covered in 8.12 through 8.14. With the exception of ammonia, most common commercial air conditioning refrigerants are either A1 or B1 type. It is important to confirm this, however.

The following is a summary of section 8:

- ❑ Foundations for refrigeration equipment shall be non-combustible and capable of supporting the weight (8.1).
- ❑ Provide guards for moving machinery (8.2).
- ❑ There should be safe access to the equipment for service (8.3).
- ❑ Water, electrical, natural gas and duct connections must meet the requirements of local authority (8.4, 8.5, 8.6 and 8.7 respectively).
- ❑ Refrigeration components in the air stream must be able to withstand 700°F without leaking.
- ❑ There are requirements on where refrigeration piping may be located (8.10).
- ❑ Other equipment is not prohibited in the chiller mechanical room unless specifically mentioned. The room must be large enough to allow service and have a clear headroom of 7.25 ft. (8.11.1).
- ❑ The mechanical room doors shall be tight fitting that open outward and be self closing if they open into the building. There must be enough doors to allow adequate escape in the event of an emergency. The mechanical room cannot have openings that will allow refrigerant to enter the occupied space in the event of leak (8.11.2).
- ❑ Each mechanical room shall have a refrigerant leak detector. The detector shall activate an alarm and ventilation system at a value not greater than the TLV-TWA of the refrigerant. The alarms shall be audio and visual and be located in the mechanical room and at each entrance to the mechanical room. There shall be a manual reset located in the mechanical room. Absorption chillers using water as the refrigerant do not require detectors (8.11.2.1).
- ❑ Chiller mechanical rooms shall be vented to the outdoors as follows (8.11.3 through 8.11.5):
 - ❑ Mechanical fans are required.
 - ❑ Openings for inlet air must be provided and situated to avoid recirculation.
 - ❑ Supply and exhaust air ducts shall serve no other area.
 - ❑ Discharge of exhaust air shall be in such a manner as not to cause a nuisance or danger.
 - ❑ The emergency ventilation capacity shall be calculated as follows:
$$Q = 100 * G^{0.5}$$
Where
Q = the airflow rate in cubic feet per minute
G = the mass of refrigerant in pounds in the largest system (i.e., the chiller), any of which is located in the chiller mechanical room.
- ❑ General ventilation shall be provided when occupied at a rate of 0.5 cfm/ft² or 20 cfm/person. The general ventilation rate must be capable of maintaining a minimum 18°F temperature rise above the inlet air or a maximum space temperature of 122°F.
- ❑ Natural ventilation is acceptable under certain circumstances such as open structures. Consult Standard 15 for information.

© Tip: The refrigerant charge of a chiller can be supplied by the chiller manufacturer. A good rule of thumb is 3 lbs. per ton.

- ❑ No open flames that use combustion air from the chiller mechanical room are allowed; for instance a natural draft boiler. Combustion equipment can be in the chiller mechanical room if:
 - ❑ Combustion air is drawn directly from outdoors or a refrigerant detector is used to shut down the combustion device in the event of a leak (8.11.6).
- ❑ There shall be no airflow from the occupied space through the chiller mechanical room unless the air is ducted and sealed in such a manner as to prevent refrigerant leakage from entering the airstream. Access doors must be gasketed and tight fitting (8.11.7).
- ❑ Access to chiller mechanical rooms shall be restricted to authorized personnel and clearly marked as restricted (8.11.8).
- ❑ The discharge from purge systems (i.e., negative pressure centrifugal chillers) shall be governed by the same rules as pressure relief and fusible plug devices. Absorption chillers using water as the refrigerant are exempt (8.14).

Design and Construction of Equipment and Systems (Section 9)

Section 9 covers the design and construction of refrigeration equipment. In most cases, the chillers are factory built and the designer will not be directly involved in the equipment design. If there is field refrigerant piping involved such as in a split system, the designer will have to be familiar with this section.

Pressure Relief Piping

One area that will involve the designer is pressure relief devices and piping. The pressure relief devices are typically part of the chiller. With field refrigerant piping, additional relief devices may be required. Medium to high pressure refrigeration systems typically use re-seating spring loaded pressure relief valves. Negative pressure chillers often use rupture disks. Rupture disks are less expensive however, if they burst, the entire charge will be lost. Spring loaded pressure relief valves will re-seat as soon as the pressure within the refrigeration system drops to safe level. For negative pressure chillers, it is recommended that reseating pressure relief valves be used in addition to rupture disks for additional protection.

Pressure relief devices and purge unit discharges must be piped to the outdoors (9.7.8). The location must not be less than 15 ft above grade or 20 ft from a window, ventilation opening or doorway. The line size shall be at least the discharge size of the pressure relief device or fusible plug.

Multiple relief devices can be connected to a common header. The header size must be at least the sum of the discharge areas of the connected devices and designed to accommodate the pressure drop. Many chiller application catalogs provide tables for sizing relief piping. ASHRAE Standard 15 also includes tables for sizing relief piping.

Operation and Testing (Section 10)

Section 10 generally deals with field-erected refrigeration systems. For factory assembled chillers this section should not be an issue. Where there has been field installed refrigerant piping, the test procedures describe in section 10 must be followed.

General Requirements (Section 11)

Section 11 covers general requirements. Permanent signs are required indicating (11.2.1):

- Name and address of installer
- Refrigerant number and amount
- Lubricant type and amount
- Field test pressure

Single Chiller System

Single chiller systems are the easiest to design and operate but are also the least efficient chiller plant design for buildings. Moreover, they provide no redundancy. If the chiller fails, all cooling is lost. Single chiller plants require the smallest mechanical room, particularly if the chiller is air or evaporatively cooled.

Basic Operation

Figure 35 shows a single water-cooled chiller plant with constant flow and 80% cooling load diversity. Chilled water is circulated by the chilled water or primary pump through the chiller to the load and back to the chiller. The chilled water loop can be either constant flow or variable flow. Variable Flow systems increase the complexity but offer significant pump work savings. Variable flow systems are covered in Primary/Secondary Systems and Variable Primary Flow Design. A condenser loop is required for water cooled chillers. This includes a condenser pump, piping and a cooling tower or closed circuit cooler. The condenser loop operates whenever the chiller operates.

Figure 35 –Basic Single Chiller System Operation

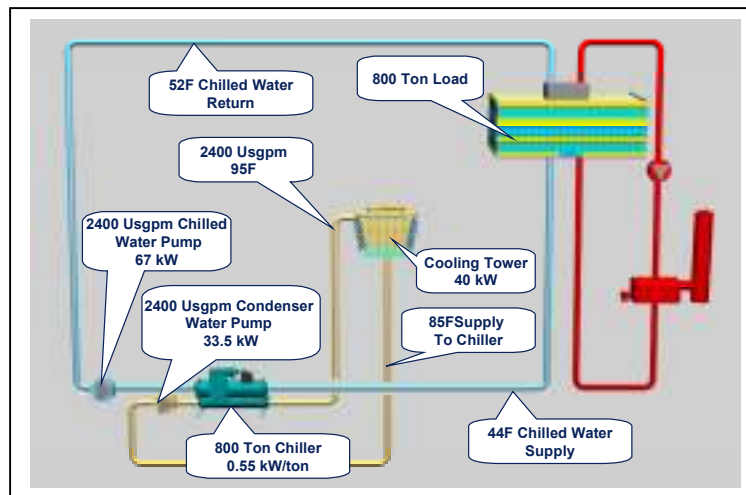

For constant flow systems, the chilled water temperature range varies directly with the load. Depending on the load diversity, the chiller design temperature range will be less than the range seen at each load. In this case, the chiller range is 8°F while the cooling coil range is 10°F (Refer to *Piping Diversity*, page 24). The overall result is increased chilled water pump and pipe capital cost plus higher annual pumping cost.

Basic Components

Chillers

The chiller is sized to meet the design load of the building or process. For building loads, the chiller only operates at full capacity for a few percent of the time. The balance of the time the chiller is operating in the 50 to 60% range (depending on the building load profile). Most chillers provide their most efficient performance at or near full load. Single chiller plant design does not promote optimal use of the chiller's performance. An exception to this is the McQuay Dual Compressor chiller, which operates at its most efficient point at 50% capacity. In addition, the dual compressor chiller offers complete redundancy of all major mechanical components, which resolves another issue with single chiller plant design.

Water-cooled, air-cooled or evaporatively-cooled chillers can be used. Air and evaporatively cooled chillers do not require a condenser loop including piping, cooling tower and pump.

Figure 36 - Typical Single Chiller System

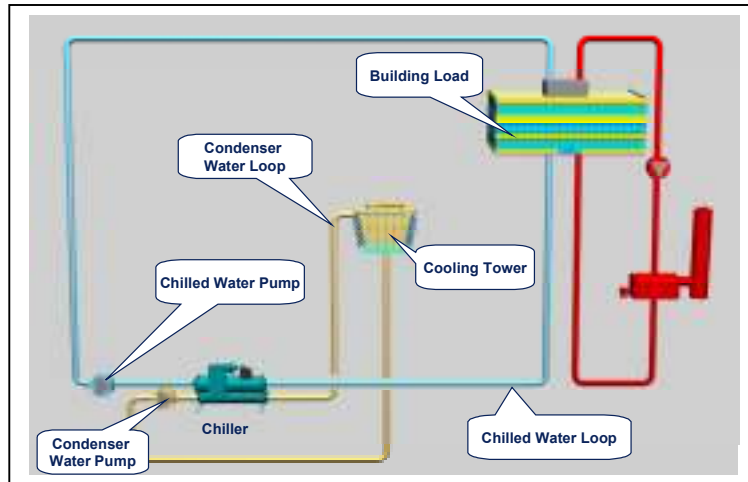

Pumps

Pumps can be constant or variable flow. Pump basics are covered in *Pumping Basics*, page 11. Both the chilled water and condenser pump must be sized for the design flowrates. Whenever the chiller operates, these pumps will operate. The result is that the design chilled water and condenser flow are being pumped any time the chiller plant is operating.

Cooling Towers

Water-cooled chiller will require cooling towers. Cooling towers are covered in *Cooling Tower Basics*, page 15.

Single Chiller Sequence of Operation

Single chiller plants are the most straightforward to operate. Recognizing the need for chilled water is the first goal. This can be as simple as manually enabling the chiller. The process can be automated with a building automation system (BAS) which can recognize when mechanical cooling is required.

All chillers must have chilled water (and condenser water, if appropriate) flow before they operate. The simplest method is to manually turn on the pumps prior to enabling the chiller. The chiller controller, in many cases, includes a signal to operate the chilled and condenser water pumps. In this case, the pump starters can be interlocked with the chiller control panel to start the pumps. Pumps should shut down when not required to save energy. The BAS can also start the pumps prior to enabling the chiller.

Variable flow systems add another degree of complexity but also provide significant pump work savings. Control sequences for variable flow systems are covered in other sections of this Guide.

© Tip: Chillers are not technically started, they are enabled. The difference is subtle but important. Enabling a chiller means the chiller is allowed to operate if it needs to. For instance, if there is no load, the chiller will not start even though it has been enabled. If you were truly starting the chiller, the compressor would start as soon as you threw the switch.

In addition to operating the pumps, it is necessary to prove that there is flow. Pressure differential or paddle type switches can be used and usually are connected directly to the chiller controller. Current sensing devices can also be used. Operating a chiller without flow can result in serious damage. It is recommended that the manufacturer's installation instructions be followed carefully to provide proper operation and avoid warranty conflicts.

Systems requiring a cooling tower will need to control it. Sequences for cooling towers are covered in detail in *Cooling Tower Controls*, page 18. Additional information on chiller plant controls can be found in product catalogs, as well as in installation and maintenance manuals.

Single Chiller Plant Example

Consider a model 7-story office building in Minneapolis with 375,000 ft². The air conditioning system is floor-by-floor VAV with reheat and a single chiller plant as shown in Figure 35.

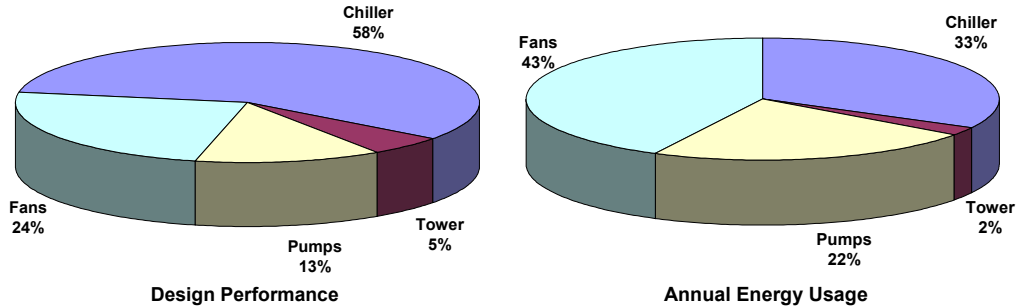

Reviewing the design performance does not indicate how well the system will operate annually. The annual kWh/yr usage tells a different story. Although pumps are much smaller than the chiller, they end up using almost two-thirds the energy that the chiller uses. This happens because the chilled water and condenser pumps must operate at plant design flow rates any time there is a requirement for chilled water.

Although fans are not part of the chiller plant, it is important to notice that they too consume a significant amount of power over the course of a year. In this case, more energy is used operating the fans than the chiller. Annual energy analysis such as this can be performed for a specific project using McQuay's Energy Analyzer™.

Parallel Chiller System

To provide some redundancy in the HVAC design, most designers will require two or more chillers. Multiple chillers also offer the opportunity to improve on overall system part load performance and reduce energy consumption. Parallel chiller plants are straightforward to design and are easily modified for variable primary flow.

Basic Operation

Figure 37 shows a parallel water-cooled chiller plant. Chilled water is circulated by the chilled water or primary pump through both chillers to the load and back to the chillers. The chilled water loop can be either constant flow or variable flow. Variable flow systems increase the complexity but offer significant pump work savings. They also resolve the issue about chiller sequencing that occurs with parallel chillers, constant flow. (See *Variable Primary Flow Design*, page 75.) Variable flow systems are covered in Primary/Secondary Systems and Variable Primary Flow Design. A condenser loop is required for water-cooled chillers. This includes a condenser pump, piping and a cooling tower or closed circuit cooler. The condenser loop operates whenever the chillers operate.

Figure 37 – Basic Parallel Chiller System Operation

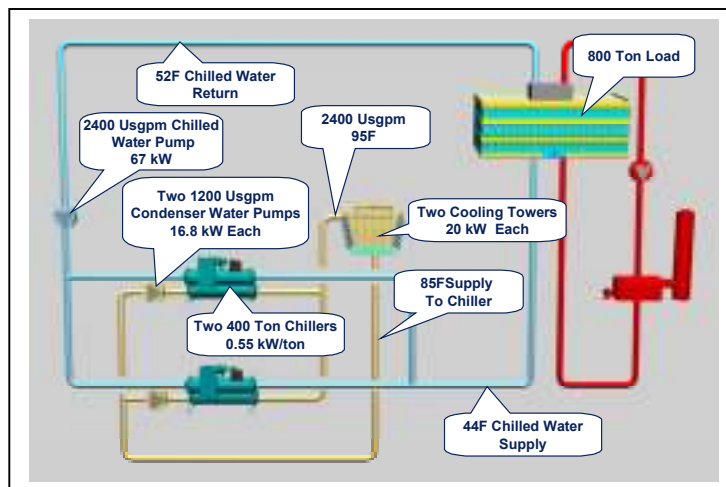

For constant flow systems, the chilled water temperature range varies directly with the load. Depending on load diversity, the chiller design temperature range will be less than the temperature range seen at each load. In this case, the chiller temperature range is 8°F while the cooling coil range is 10°F (Refer to *Piping Diversity*, page 24). The overall result is increased chilled water pump and pipe capital cost plus higher annual pumping cost.

Basic Components

Chillers

In most cases, the sum of the chiller capacities meets the design for the building or process. Additional capacity can be added, if required, by oversizing the chillers. It is common for parallel chillers to be the same size and type although this not a requirement. Water-cooled, air-cooled or evaporatively-cooled chillers can be used. Air and evaporatively-cooled chillers do not require a condenser loop including piping, cooling tower and pump.

© Tip: Parallel chillers experience the same percent load. For example, consider a chiller plant with a 100-ton and a 1000-ton chiller operating at 50% capacity. With both chillers operating, both chillers will operate at 50% capacity. The 100-ton chiller will be at 50 tons and the 1000-ton chiller will be at 500 tons. This occurs as long as the flows don't change (i.e., variable primary flow) and both chillers see the same return water temperature.

Pumps

Pumps can be constant or variable flow. Pump basics are covered in *Pumping Basics*, page 11. The chilled water pump is sized for the design flowrate. Figure 38 shows one main chilled water pump providing flow to both chillers. An alternative method is to have two smaller pumps serving dedicated chillers. Figure 38 also shows dedicated condenser pumps and cooling towers for each chiller. The pumps and piping are sized for the design condenser flow for each chiller. Whenever the chiller operates, the condenser pump operates.

Figure 38 - Typical Parallel Chiller System

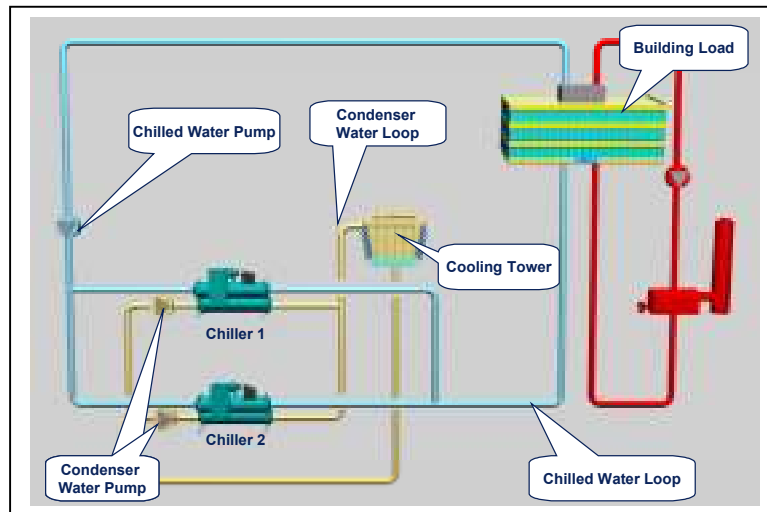

Cooling Towers

Water-cooled chillers will require cooling towers. Figure 38 shows dedicated cooling towers for each chiller. A common cooling tower is also possible but not common for parallel chillers. Cooling towers are covered in *Cooling Tower Basics*, page 15.

Parallel Chiller Sequence of Operation

Parallel chiller plants create a unique situation when used in a constant flow system. Consider the system operating at 50%. From a chiller performance aspect, turning off one chiller and operating the other at full capacity is desirable. However, this will not happen. At 50% capacity, the return water will be 49°F. The chiller that is turned off will let the water pass through it unchanged. The operating chiller will only see a 50% load (49°F return water), and will cool the water down to the set point of 44°F. The two chilled water streams will then mix to 46.5°F supply temperature.

If the system is operated in this manner, the warmer chilled water will cause the control valves to open (increase flow) to meet the space requirements. An iterative process will occur and the system may stabilize. The issue is whether the cooling coils can meet the local loads with the higher chilled water temperature. Depending on the actual design conditions, the building *sensible* load could be met but high chilled water temperature will make it difficult to meet the *latent* load. Since this scenario is likely to occur during intermediate weather, dehumidification may not be an issue. In areas where humidity is an issue, this arrangement can result in high humidity within the space.

One solution is to operate both chillers all the time. This works and is a simple solution, however, it is not energy efficient and causes unnecessary equipment wear.

Another possibility is to lower the operating chiller's set point to offset the mixed water temperature. This also works but has some difficulties. Lowering the chilled water setpoint requires the chiller to work harder, lowering its efficiency. In extreme conditions, it can cause chiller stability issues.

Adding isolation valves to stop flow through a chiller when it is not operating is not recommended for a constant flow system. It is unlikely that the pump will be able to provide design flow if all the chilled water is directed through just one chiller. The pump will ride its curve and a loss of flow will occur. Without design flow, it is unlikely that all the individual loads will receive their required flows. In the event the pump could actually provide the flow through one chiller, the maximum allowable flow rate for the chiller may be exceeded resulting in serious damage to the chiller.

The safe answer is to operate both chillers all the time chilled water is required, however, this is as expensive as operating a single chiller plant. Staging on the pumps and cooling towers is similar to that outlined for single chillers. Refer to Single Chiller Sequence of Operation, page 39.

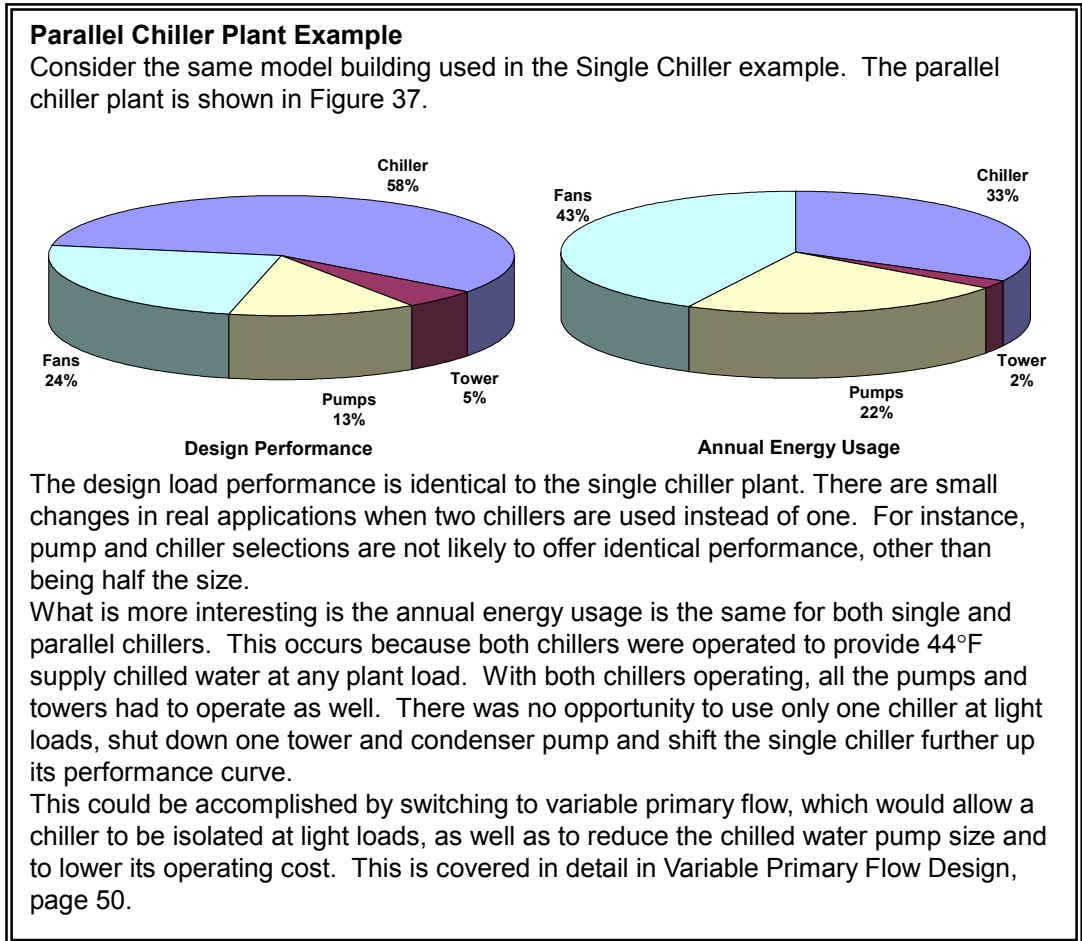

Series Chillers

Series chillers are another method of operating more than one chiller in a plant. This design concept resolves the mixed flow issues found in parallel chiller designs. The chillers can be preferentially loaded as well, allowing the designer to optimize chiller performance. Series chiller systems are straightforward to design and operate.

Basic Operation

Figure 39 shows two chillers in series. All the system flow goes through both chillers. As a result, the water pressure drops through the evaporators are additive. The chilled water loop can be either constant or variable flow. Variable flow systems increase the complexity but offer significant pump savings. Variable flow systems are covered in Primary/Secondary Systems and Variable Primary Flow Design. A condenser loop is required for water cooled chillers. This includes a condenser pump, piping and a cooling tower or closed circuit cooler. The condenser loop operates whenever the chillers operate.

If both chillers are the same and the condensers are piped in parallel, the lead chiller will accomplish about 45% of the system load and the lag chiller will accomplish about 55% of the system load. This occurs because the lead (downstream) chiller is supplying chiller water at the system set point (typically 44°F). The lag (upstream) chiller is supplying chilled water at approximately 48.5°F to the lead chiller. The reduced lift for the lag chiller allows it to provide more cooling capacity.

Figure 39 – Basic Series Chiller System Operation

For constant flow systems, the chilled water temperature range varies directly with the load. Depending on the load diversity, the chiller design temperature range will be less than the range seen at each load. In this case, the chiller range is 8°F while the cooling coil range is 10°F (Refer to *Piping Diversity*, page 24). The overall result is an increased chilled water pump and pipe capital cost plus higher annual pumping cost.

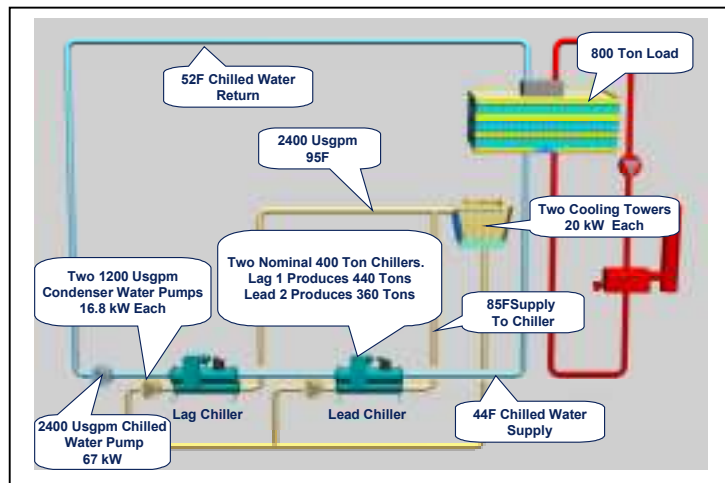

A problem with series chillers is the high flow rate and the low temperature range through the chillers. The high flow rate can result in high water pressure drops. Since the chillers are in series, the pressure drops of the chillers must be added. If the typical 10°F system temperature difference is maintained, then single pass evaporators should be considered. This will lower the pressure drop to an acceptable level.

Basic Components

Chillers

Chillers selected for series applications require special consideration. Special care should be taken when using smaller chillers with limited shell arrangements such as small air or water-cooled chillers. The pressure drops are typically designed to be acceptable with the flow rates around 2.4 gpm/ton. When the flow is increased to 4.8 gpm/ton as in series applications, the pressure drop rises significantly. A 10 ft. pressure drop at 2.4 gpm/ton will be a 40 ft pressure drop at 4.8 gpm/ton. With larger chillers that offer flexible shell arrangements, single pass shells can be used to lower the

pressure drop. Two single pass shells in series will be comparable to a typical two-pass shell in water pressure drop.

The chillers will not see the same duty; the lead chiller has a different lift requirement than the lag chiller. The more difficult duty is the lead chiller. The selections must be

© *Tip: For series chillers, the evaporator pressure prods must be added. Care should be taken when using chillers with limited shell arrangements such as small air or water-cooled products. The pressure drops (at the correct flow rate) can be very high. For larger chillers with flexible shell arrangements, consider single pass to reduce the water pressure drops.*

done so that the chillers operating at the specific conditions will provide the required capacity. The actual chiller output and performance will most likely be different. Selecting both chillers to be the same machine and able to meet the requirements of the lead position allows the chillers to be interchangeable when the plant load is less than one chiller's capacity. There is some performance loss when the chiller is operated in the lag position because the chiller is not optimized for that specific lift. It is possible to select two different chillers, each optimized for their operating conditions. This arrangement will be slightly (about 2%) more efficient but the chillers will not be interchangeable.

Increasing the chilled water temperature range affects series chillers differently than parallel chillers.

As the range is increased, series chillers will generally outperform parallel chiller arrangement. This occurs because the cascading effect of series chillers enhances the chillers' performance.

© *Tip: Series chillers operate more effectively at increased chilled water temperature ranges than parallel chillers. As the chilled water range is increased, you can expect series chiller arrangements to outperform parallel chiller arrangements.*

Pumps

Pumps can be constant or variable flow. Pump basics are covered in ***Pumping Basics***, page 11. The chilled water pump is sized for the design flow rate. The chilled water design head will be impacted by having to add the chiller pressure drops together. Figure 40 shows one main chilled water pump providing flow through both chillers. Figure 40 also shows dedicated condenser pumps and cooling towers for each chiller in a parallel arrangement. The pumps and piping are sized for the design condenser flow for each chiller. Whenever the chiller operates, the condenser pump operates.

Figure 40 - Typical Series Chiller System

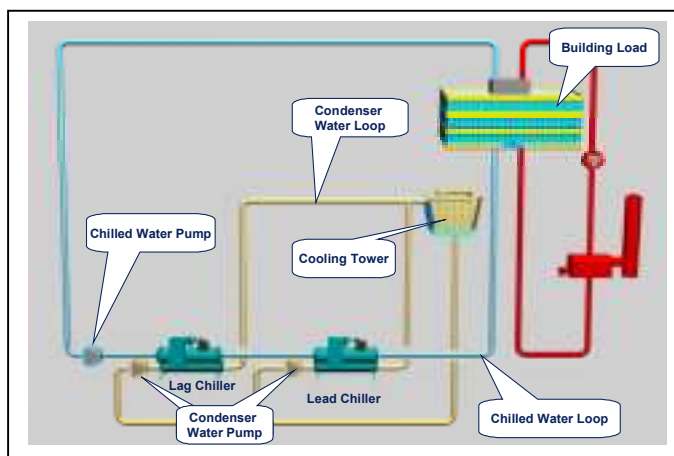

Cooling Towers

Water cooled chillers will require cooling towers. Figure 40 shows dedicated cooling towers for each chiller. A common cooling tower is also possible but not common for series chillers. Cooling towers are covered in ***Cooling Tower Basics***, page 15.

Series Chillers Sequence of Operation

Series chillers can preferentially load chillers. As the chiller plant load increases, the lead (downstream) chiller will load from 0 to 100% capacity to meet it. Once the lead chiller is loaded (which is likely to be about 45% of plant capacity) the lag chiller is started. Here are three ways to operate the lag chiller:

1. Set the upstream chiller chilled water setpoint to bring on the chiller once the downstream chiller is fully loaded. This will preferentially load the downstream chiller. The downstream chiller will operate at full load while the upstream chiller will ramp up as the chiller plant load goes from about 45% to 100%. If the downstream chiller is offline for any reason, the upstream chiller will not be able to assume its role unless the chilled water setpoint is changed, either manually or remotely.
2. Move the upstream chiller sensor downstream of both chillers. This will preferentially load the upstream chiller. Once the upstream chiller cannot maintain the chilled water supply temperature, the downstream chiller will start and provide the balance of the load.
3. Modern chiller controllers such as McQuay's Microtech™ controllers can allow two chillers to communicate. In this arrangement. Either chiller can be the first chiller on (assuming they were both selected to do the lead chiller duty). Once the first chiller is fully loaded, the second chiller will start and the load will be evenly balanced between the two chillers. This can result in about a 2% improvement in annual chiller energy usage. Where possible, this method is recommended.

Staging on the pumps and cooling towers is similar to that outlined for single chillers. Refer to *Single Chiller Sequence of Operation*, page 39.

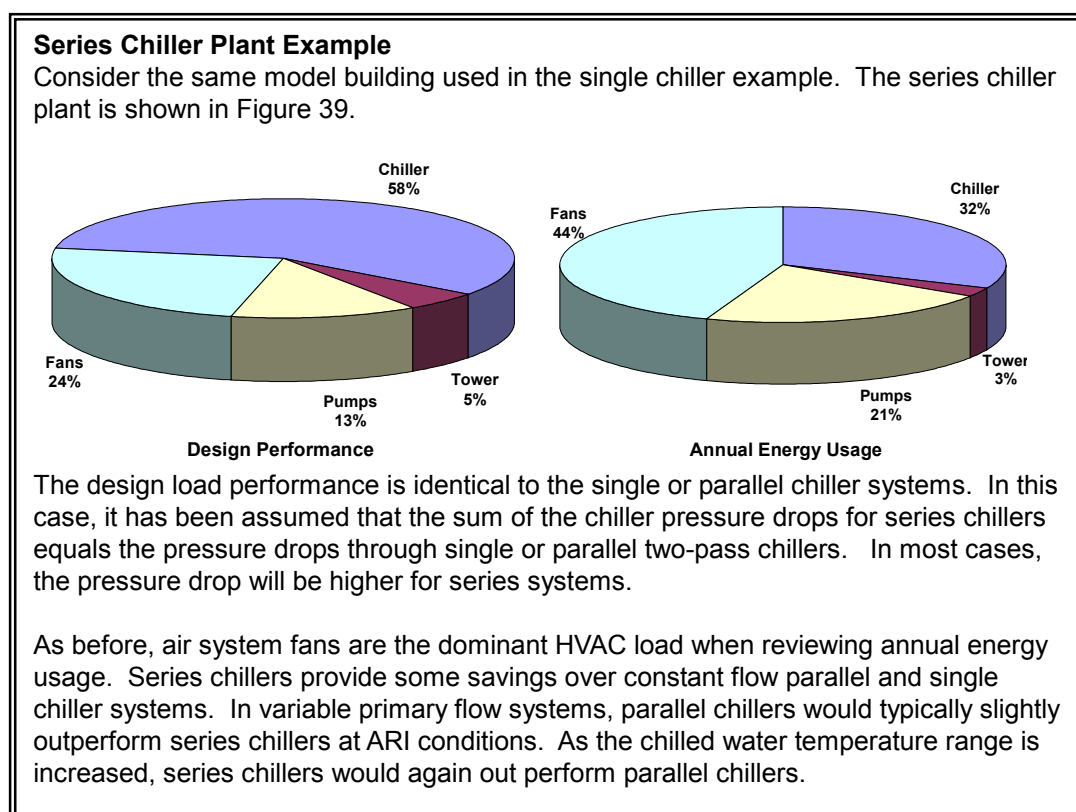

Series Counterflow Chillers

Series counterflow chillers are shown in Figure 41. This arrangement differs from the series chillers system shown in Figure 39 in that the condenser flow passes through both chillers in series, counterflow to the chilled water. Series counterflow condenser water improves the chiller performance as explained in the Series counterflow chiller example.

Figure 41 - Series Counterflow System Design

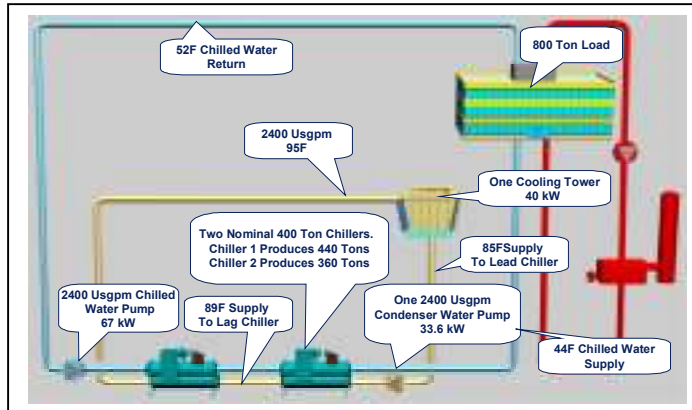

Series counter flow chillers can be 5 to 7% more efficient than a single chiller at design conditions and save up to 20% of chiller energy annually. However, the condenser pump is sized for the entire system flow (in this case 2400 US gpm) and this pump must operate whenever any chiller operates. The result is increased pump work annually. Series chillers with parallel towers may out perform series counterflow

chillers depending on the chiller savings versus pump losses. Where series counterflow chillers can be advantageous is in large primary/secondary chiller plant systems.

Series Counterflow Chillers vs. Series Parallel Chillers

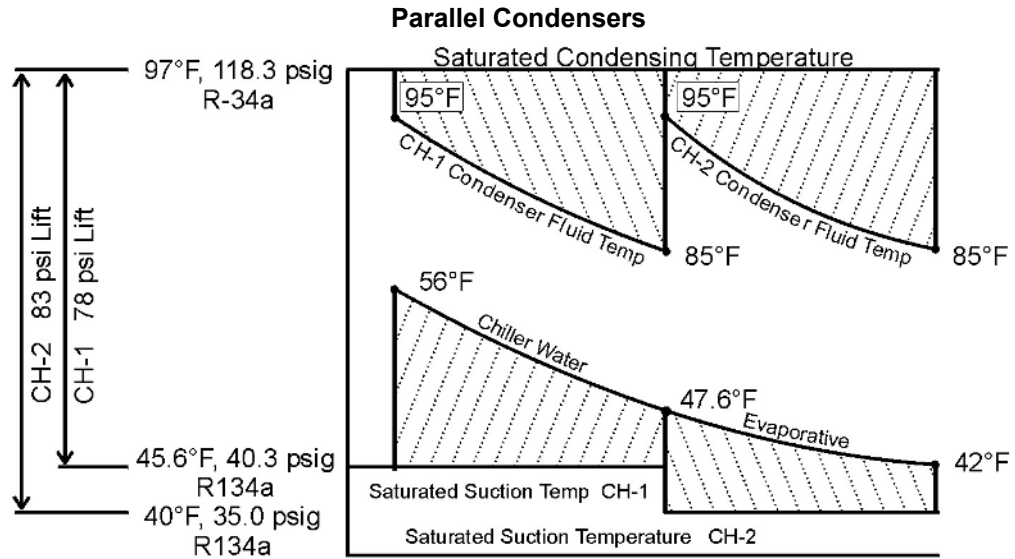

The lower figure shows series chillers with the condensers piped in series counterflow to the chilled water. The arrangement enhances the chiller performance by “cascading” the chillers. The above figure shows the lift requirements for series chillers with parallel towers. Chiller 1 has a smaller lift because it sees the return chilled water. Chiller 2 sees a higher lift because it cools the water to 42°F. Since both chillers have the same discharge pressure requirement (dictated by using 85°F-95°F condenser water), the chiller lifts are different.

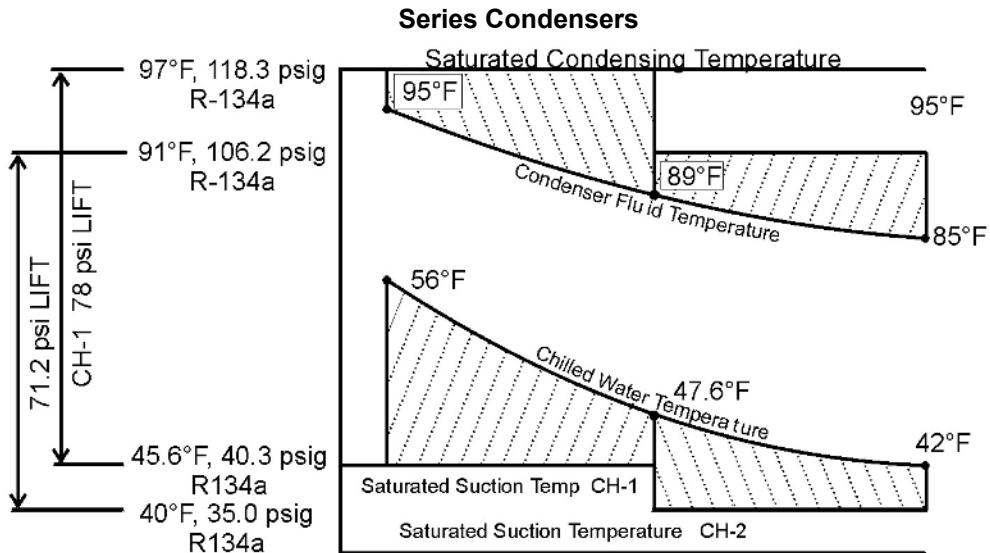

The above figure shows the lift requirements for series counterflow chillers. Now chiller-2 sees a lower lift because the discharge pressure has been reduced as a result of the lower condenser water temperatures. The chiller lifts are almost balanced which will always provide the best refrigeration performance.

Using VFD Chillers in Series Arrangements

A common practice in selecting chillers for series applications is to select both chillers to be the same and meet the lead (most demanding lift) chiller duty. For centrifugal chillers, this means the compressors are selected for the largest lift on a design day. The chiller that is then used as the lag chiller provides too much lift and is not optimized. A solution to this is to use a centrifugal chiller with a VFD as the upstream chiller. This has two advantages:

1. During periods when the chiller plant load is less than 45% (about the limit for one chiller) the VFD chiller can be used and take advantage of any condenser relief available. Considering this is a part load situation, condenser relief should be significant.
2. When two chillers are required, the VFD chiller can use the VFD to optimize its performance while being used in the lower lift application.

Both chillers do not need to have VFDs. Either chiller will work in either application (lead or lag) without a VFD.

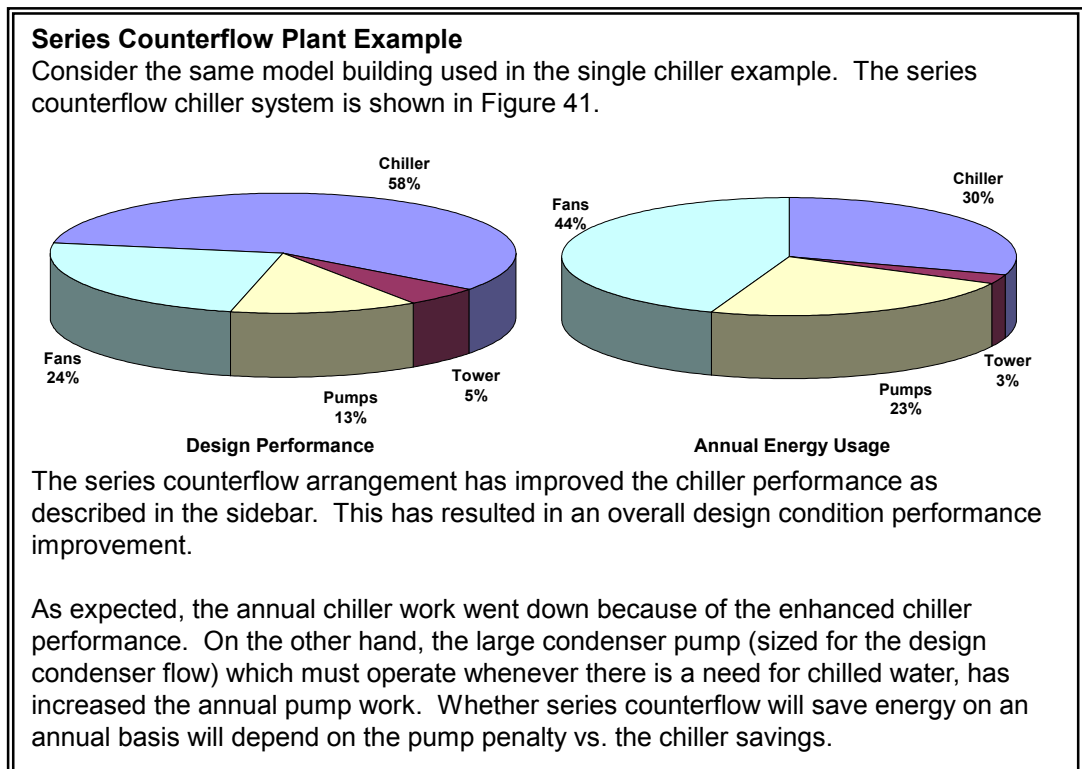

System Comparison

The previous section covered several common chiller system designs based on constant flow systems. Each system has strengths and weaknesses in terms of design. A key operating parameter is the annual energy usage.

Table 5 - Design Condition Performance In kW

Systems	Chiller	Pumps	Cooling Tower	AHU Fans	Total
Single Chiller	440	100	40	185	765
Parallel Chillers	440	100	40	185	765
Series Chillers	440	100	40	185	765
Series Counterflow Chillers	424	100	40	185	749

Table 5 shows the design condition power usage of the chiller systems covered in the last section. As can be seen, all the systems have the same full load performance. The series counterflow chillers provide better performance than the other systems because of the cascading effect. At nominal ARI conditions, these chillers would perform the same as the other chillers.

Table 6 shows the annual energy usage of the various chiller systems. This tells quite a different story. The single and parallel chiller plants perform the same because the parallel system operates the two chillers at all load points. There is no easy way to shut down a chiller in a parallel, constant flow arrangement.

Table 6 - Annual Energy Usage In kWh/yr

Systems	Chiller	Pumps	Cooling Tower	AHU Fans	Total
Single Chiller	258,344	175,689	16,597	334,237	784,867
Parallel Chillers	258,344	175,689	16,597	334,237	784,867
Series Chillers	237,607	160,762	19,243	334,237	751,849
Series Counterflow Chillers	227,718	173,564	19,153	334,237	754,672

The series chillers outperformed the parallel chillers. The water pressure drops, however, were held constant. If the water pressure drops through the series chillers had been increased as is typically the case, then there would have been little or no difference.

At design conditions, the series counterflow chillers appeared to have a distinct advantage, however, the pump penalty on the condenser side actually increased the overall annual energy usage. Here are some relationships that can be used:

- ❑ Design performance is a poor indicator of annual performance. There is no way to tell which system will perform the best by reviewing the design condition performance.
- ❑ Sequence of operation is a major factor. How the system operates will vastly affect the savings.
- ❑ In constant flow systems, pumps are a major component. Although the pump motors are only 25% the size of the chiller, they use more than 60% of the power that the chiller uses.
- ❑ Increasing the chilled water temperature range will improve the performance of the series chiller systems relative to other chiller systems. The chillers will operate more efficiently and the pressure drop penalty will be less of an issue.
- ❑ Variable flow systems can save significant pump energy. They will be discussed in future sections.

Primary/Secondary Systems

For large chillers or where more than two chillers are anticipated, primary/secondary (also called decoupled) piping systems are often used. To reduce installation and operating costs, it is desirable to apply diversity to system flow. With diversity applied to flow, the pumps and piping will be smaller. To accomplish this, two-way control valves are used at the loads. At the same time it is desirable to provide constant flow through the chillers to maintain chiller stability. The solution is primary/secondary piping.

Basic Operation

Figure 42 - Basic Primary/Secondary System Operation (50% Load)

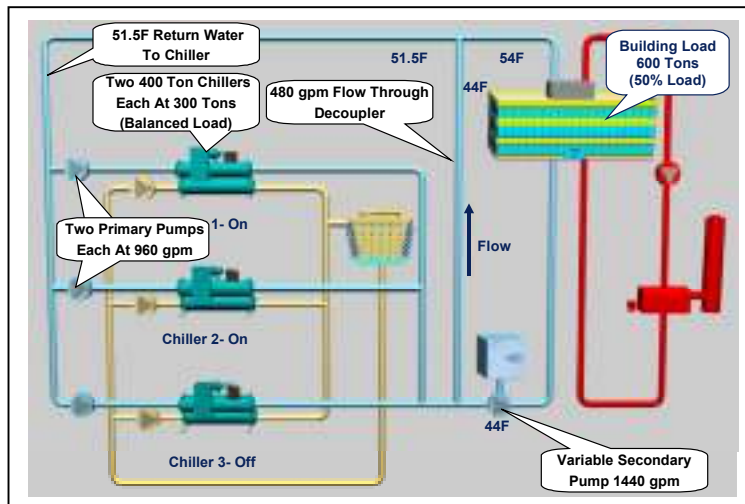

Figure 42 shows a 1200-ton primary secondary system with three chillers. The system is operating at 50% or 600 tons. The 600-ton load requires 1440 gpm. Two chillers are operating along with their 960 gpm primary pumps.

The additional flow from the two primary pumps bypasses the building through the decoupler. The bypassed water mixes with the return water from the building and

is returned to the chillers. Both chillers operate at the same percent load (300 tons).

Basic Components

Figure 43 – Typical Primary/Secondary System

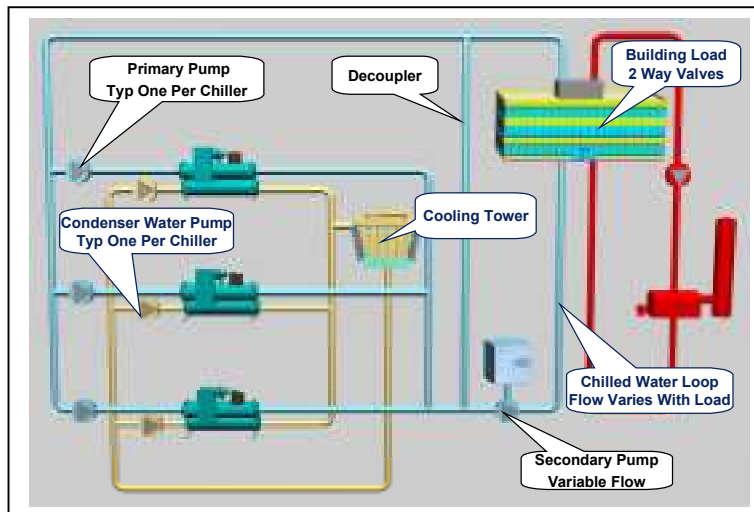

Chillers

Figure 43 shows a typical primary secondary chiller plant with four chillers. They can have any number of chillers. Any size and type of chiller can be used. Different capacity chillers are acceptable and can be advantageous depending on the load profile. The only requirement is all chillers must operate on the same chilled water temperature range. Unless specially configured (See *Decoupler*, page 53) all operating chillers will have the same percent load.

☺ *Tip: All operating chillers in a primary-secondary plant see the same percent load. For example, consider a plant consisting of one 100-ton chiller and one 1000-ton chiller operating at 50% load. In this case, the 100-ton chiller will operate at 50 tons and the 1000-ton chiller at 500 tons. Preferentially or backloading chillers is possible, see *Decoupler*.*

Primary Pumps

Primary pumps provide constant flow through the chillers. They can be dedicated to each chiller as shown or there can be a primary pumping plant providing constant flow to each chiller. Primary pumps can utilize a common header (See Figure 44) to allow a particular pump to serve several chillers. The advantage is should a pump fail, the chiller can still be used by activating one of the other pumps. A spare pump can also be built into the arrangement. The disadvantage to headered primary pumps is complexity and cost.

If the chillers have different flow requirements (meaning they are different sizes) then intermixing pumps becomes even more complicated. It can be done using VFDs on the pumps. The BAS can be preprogrammed with the appropriate pump speed required to deliver the correct flow to each chiller. This allows each chiller to receive its correct flow rate.

Figure 44 - Alternative Primary Pump Arrangement

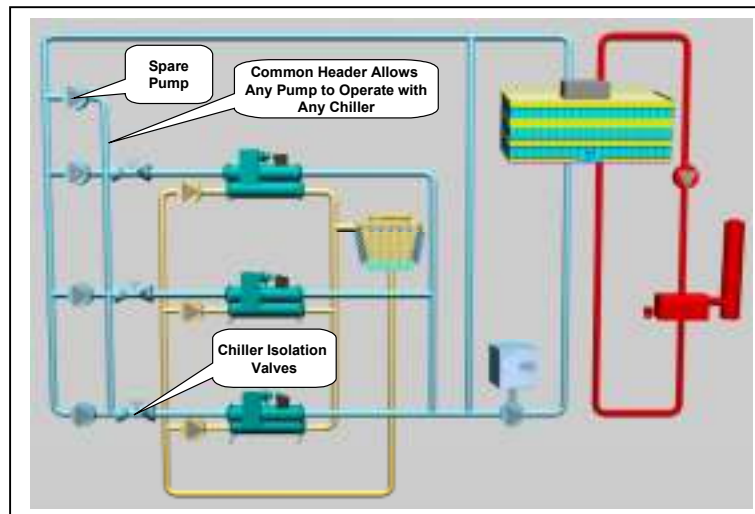

The flow for each chiller is based on the design flow required by the chiller. The flow is only provided when the chiller is operating. An automatic isolating valve is required for each chiller to stop short-circuiting when the chiller and pump are off.

Primary pumps need only provide enough head to move chilled water through the chiller and the piping pressure drops between the chiller and the secondary pumps. Heads in the range of 25 to 75 ft are common.

Condenser Pumps

If the chillers are water cooled, each chiller will have a condenser pump and cooling tower or other form of heat rejection device. Like the primary pumps, the condenser pumps can be dedicated to each chiller as shown or a condenser water pump plant can provide condenser flow. The flow rate to each chiller is typically constant and based on the design flow rate for the chiller. Where the head pressure drop is particularly high, variable flow condenser pumps may offer additional savings and are becoming more common in chiller plant design.

Cooling Towers

Cooling towers can be grouped or individual. Individual towers allow the tower to be sized specifically for the chillers needs, which can be important in hybrid chiller plants. Refer to *Cooling Tower Basics*, page 15 for more details.

Secondary Pumps

Figure 45 - Basic Secondary Loop

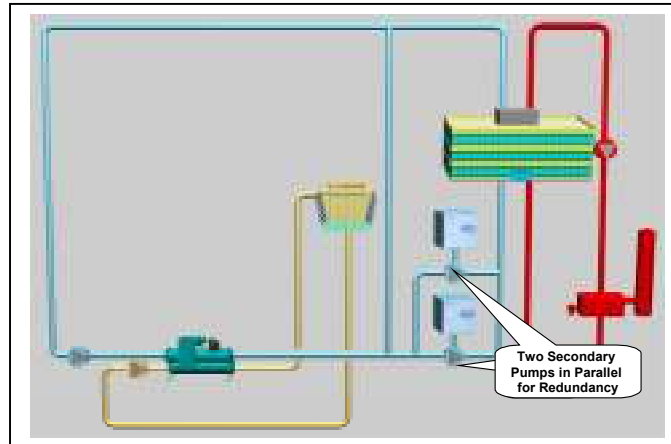

Secondary pumps are variable flow and sized to provide flow throughout the chilled water plant. In a sense, they handle all the pressure drops “outside the mechanical room”. Refer to *Variable Flow Pumps*, page 13 on how to vary the flow through pumps.

Most secondary pump arrangements include multiple pumps and often a spare pump.

Figure 46 - Multiple Secondary Loops

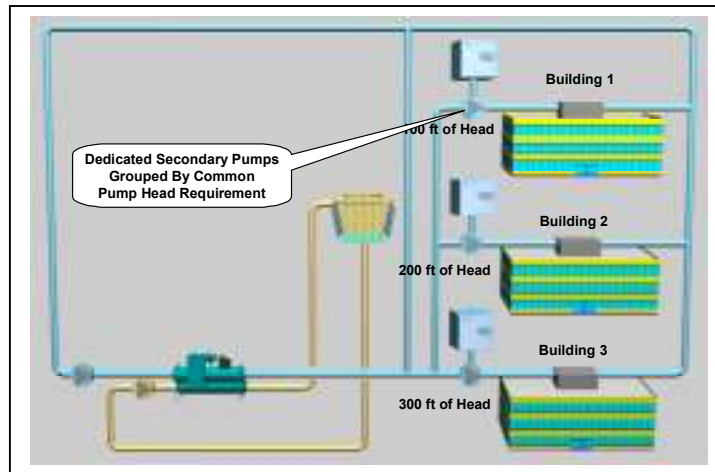

Figure 46 shows dedicated pumps for various loops. Multiple loops can serve areas with different operating schedules or widely different fluid pressure drops (such as a building on the far side of a campus). The individual loops can be scheduled off when not required. A good system design should always group loads with common pressure drop and scheduling requirements to reduce pumping work.

Decoupler

Referring to Figure 45 it would appear that the primary and secondary pumps are in series. This is not the case however, because of the decoupler. The decoupler allows the pumps to operate at different flow rates. This is necessary because the primary pumps are fixed speed and the secondary pumps are variable speed. Only on special occasions will the primary pump flow and the secondary flow be equal. An example would be when the cooling load (and secondary flow) can be met by a fully loaded chiller.

Figure 47 - Primary Vs. Secondary Flow

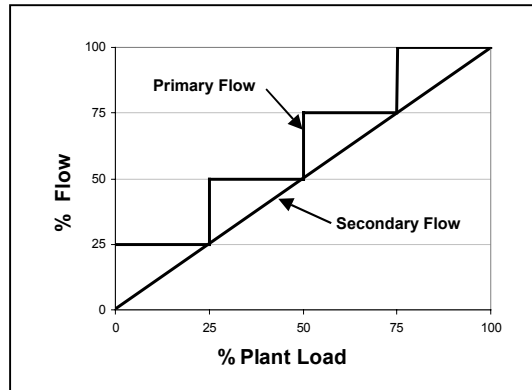
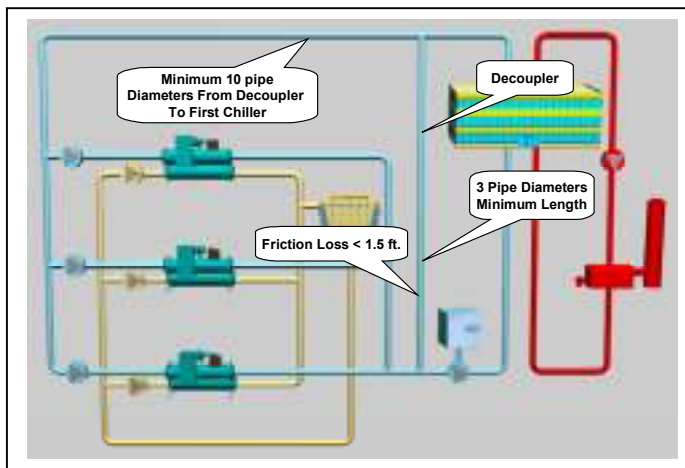

Figure 47 shows primary flow vs. secondary flow. Secondary flow is based on the load in the building. Specifically, the secondary flow rate is produced to maintain the necessary system pressure differential. Primary flow must always meet or exceed the secondary flow. Any excess primary water flows through the decoupler to the return side and back to the chillers. Any time the primary flow is less than the secondary flow, warm return water will flow “backwards” through the decoupler and mix the primary flow going out to the building.

Decoupler Sizing

Decouplers should be sized for the flow rate of the largest primary pump. This may be more than the design flow rate of the largest chiller if overpumping is being considered. The pressure drop should not exceed 1.5 ft. As the pressure drop through the decoupler increases, it tends to make the primary and secondary pumps behave like they are in series.

Figure 48 - Decoupler Sizing



To avoid thermal contamination, the decoupler should be at least three pipe diameters in length. Longer decouplers tend to increase the pressure drop. When the secondary return flows straight through in the tee to the primary return, there should be at least 10 pipe diameters to the first chiller. This is to help avoid the possibility of having stratification in the primary return line, which can lead to unmixed water to the first chiller. This can lead to chiller cycling.

Decoupler Location

The location of the decoupler line will change how the chillers are loaded. Figure 43 shows the typical layout with the decoupler between the chillers and the load. In this situation, each chiller sees the same return water temperature even at part load conditions.

© Tip: In situations where a new chiller is added to an older existing chiller plant, relocating the decoupler can take full advantage of the new chiller’s part load performance. Older chiller may operate at 1 kW/ton or more at full load, worse at part load. Relocating the decoupler allows the older chillers to be base loaded (their best operating point) while the new chiller is operated at part load. Consider either a VFD or dual compressor chiller for additional savings.

Figure 49 shows the decoupler line in a different location. Locating the chillers between the secondary loop and the decoupler line causes the return water temperature to each chiller to vary. This is often referred to as “backloading” or “preferentially” loading the chillers. Chiller 2 in Figure 49 will see close to the secondary loop return water temperature. Chiller 1 will see a mixture of supply water and return water. As a result Chiller 2 is more heavily loaded than Chiller 1.

Figure 49 - Backloaded Primary Loop Layout

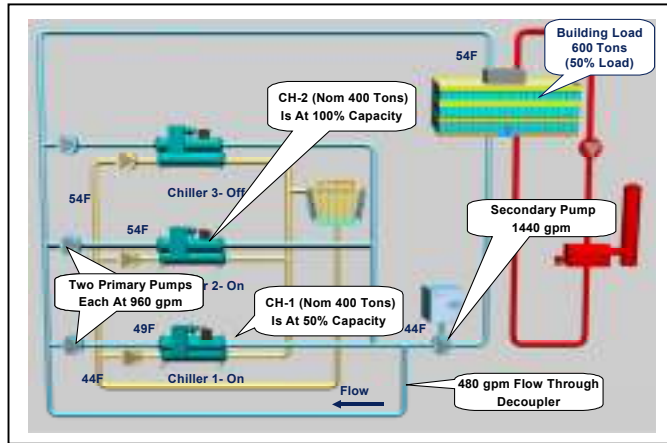

Relocating the decoupler can make sense if one or more of the chillers is a dual compressor model. The dual compressor chiller has very good part load performance. Single compressor chillers typically work best when fully loaded. By locating the dual compressor chiller close to the decoupler line and the single compressor chiller furthest away, the strengths of each chiller can be maximized. Another application for backloading chillers is where one of the chillers is a heat recovery

type or a McQuay Templifier™ is connected to the condenser loop. In this case, providing additional load to that chiller provides a heat source for the energy recovery process.

Decouplers should be sized for the maximum design chilled water flow through the largest chiller. Their length should be as short as possible to minimize pressure drop.

Backloaded Chiller Example

The table below shows the chiller plant performance for Figure 42 and Figure 49. Assume for Figure 42 the two chillers are standard 400-ton single compressor type. In Figure 49, Chiller 1 is a standard chiller while Chiller 2 is a dual compressor chiller with outstanding part load efficiency. By base loading the single compressor chiller and taking advantage of the dual chiller's part load performance, the power input can be cut by up to 10 percent.

Chiller Plant Performance vs. Decoupler Location

Figure 45	Cap. (tons)	RWT (°F)	SWT (°F)	Power (kw)
CH-1	300	51.5	44	124.6
CH-2	300	51.5	44	124.6
Total	600	51.5	44	249.2
Figure 52				
CH-1	200	49	44	73.2
CH-2	400	54	44	151.7
Total	600		44	224.9

Tertiary Pumping

Figure 50 - Tertiary Pumping

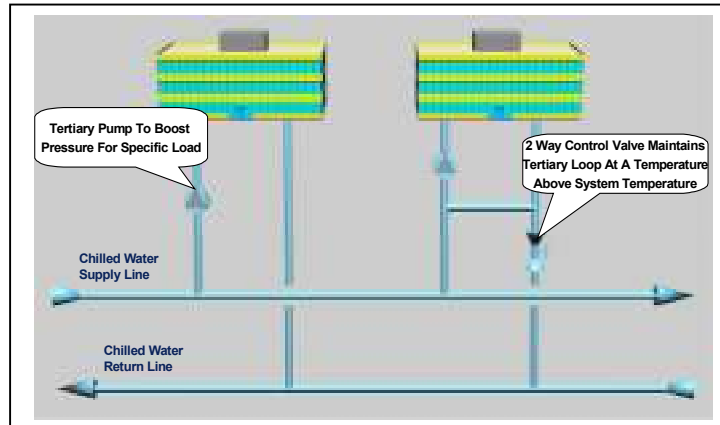

There are two key applications where tertiary piping is helpful. The first is where the pressure available in the secondary loop is not sufficient for a specific load. The second is where a load requires a different temperature range than the main system.

Figure 50 shows two piping methods for tertiary piping. The method on the left can be used to assist where the pressure drop for a specific

load is greater than the pressure differential available in the main secondary loop. This often happens when a new load is added to an existing loop. An additional tertiary pump is added to provide additional pressure to overcome the specific load.

The arrangement on the right of Figure 50 includes a tertiary pump, common pipe and a two-way control valve. The tertiary pump provides the necessary flow and head for the facility it serves. If the two-way valve is closed, the chilled water recirculates in the facility through the common pipe. As the two-way valve is opened, warm water is returned to the return header while cool chilled water is introduced.

© Tip: There are many instances where facilities designed with different chilled water temperature ranges are required to operate from a common chilled water plant. This is a common occurrence for large university and health care campuses. Tertiary piping can be used to connect buildings with different design temperature ranges and supply water temperatures to a common plant.

This arrangement can be variable flow by making the tertiary pump variable. A key advantage of this arrangement is the tertiary loop does not have to have the same temperature range as the main loop. The design chilled water temperature in the tertiary loop must be warmer than the main supply chilled water temperature. If they are the same temperature, the two-way valve will open and bleed supply water into the return line leading to low delta T syndrome (See **Low Delta T Syndrome Causes and Solutions**, page 82). The two-way valve should control to maintain the tertiary loop supply temperature (approximately 2°F warmer than the main loop) and should close when the tertiary loop is not in operation to avoid unnecessary crossflow.

System Expansion

Figure 51 - Expanding the System

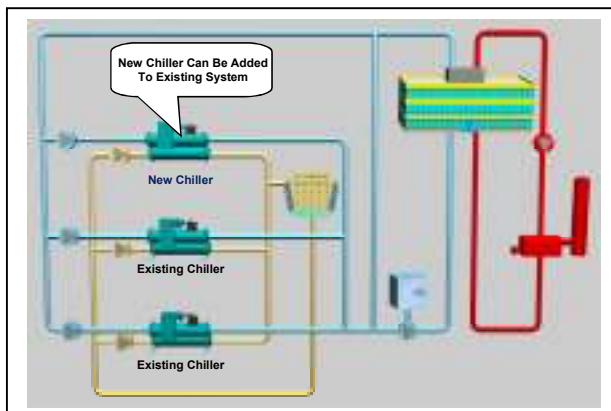

Primary/secondary piping allows easy expansion both in the chiller plant (primary loop) and the building (secondary loop). To expand the chiller plant capacity, another chiller can be added to the loop as shown in Figure 51. By strategically locating the decoupler and the new chiller (see Figure 49), it is possible to apply a greater load on the new chiller. This can be advantageous if the new chiller is more efficient than the rest of the plant.

If the building load is increased, a new loop can be added. The pump for the new loop can be sized to meet the new loop's pressure drop requirements.

Varying Chiller Sizes

One advantage of primary/secondary systems is varying the chiller sizes. As long as the supply water temperature and the design delta T are the same, the chillers can have different capacities.

Varying the chiller sizes allows chillers to be selected so the chiller plant is at maximum performance when the run-hours are highest. For example, consider a chiller plant where two chillers can be used. The bulk of the run-hours will be at 50% to 70% of design capacity. This will require the two equally sized chillers to operate between 50% and 70% of their design capacity.

© *Tip: Healthcare facilities using constant volume with reheat systems have a significant base load. The only variable load is the ventilation load. This makes health care facilities an excellent choice for varying chiller sizes.*

By varying the chiller sizes to one at 700 tons and one at 300 tons, the system load can be met with one chiller for the bulk of the operating time. The savings come from operating one chiller at near full load conditions over two chillers at part load conditions and from avoiding operating additional ancillary devices such as primary and condenser pumps.

Variable Chiller Size Example

Consider a 320,000-square foot hospital in Minneapolis. The design load is 1000 tons. The primary system is a two chiller primary/secondary system. The graph below compares two 500-ton chillers, a 700-ton dual compressor chiller with a 300-ton chiller and a 700-ton VFD chiller with a 300-ton chiller.

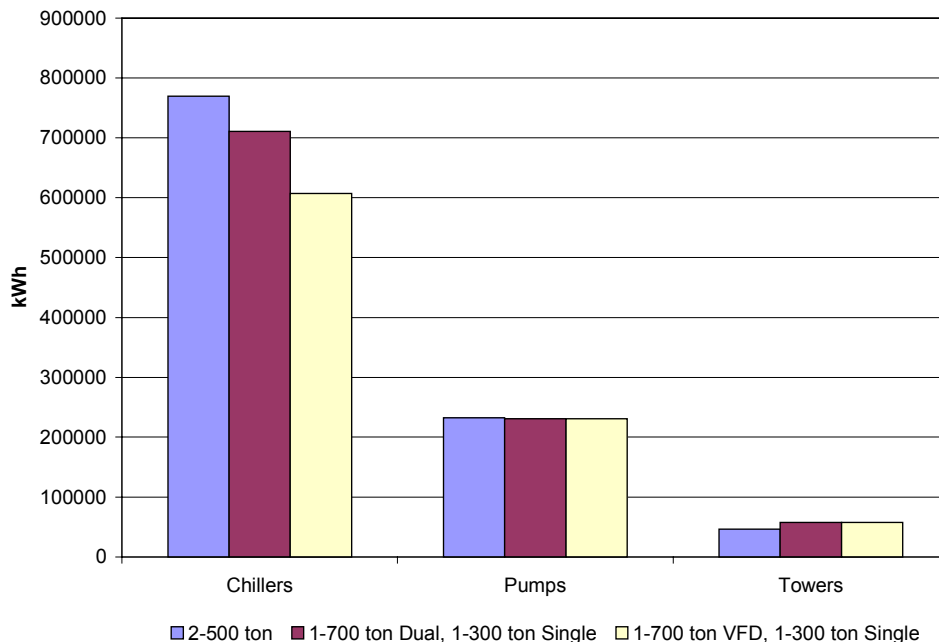

The two 500-ton chillers provide a benchmark. Since the hospital has a load profile with many hours between 50 and 70% of design capacity, the next two options outperform the benchmark. During these hours, only one chiller is required to meet the load avoiding the need for two primary and condenser pumps. The result is more efficient use of the chiller and reduced pump work.

To take full advantage of the situation, the larger chillers are either dual compressor type or VFD type, both of which have excellent part load performance. Even if one of the benchmark chillers were switched to a VFD chiller, the two options would still have had better performance.

During the spring and fall seasons, the operator has the option of using the chiller whose size best fits the expected load. For instance, on a light load day, the smaller chiller can be used. The chiller will be more fully loaded than the larger chiller offering a performance improvement for the chiller. In addition, the smaller primary condenser pump and tower fan will be used offering ancillary equipment savings.

Very Large Chiller Plants

Very large chilled water plants follow the same basic design considerations discussed so far. The scale of large chiller plants, however, creates some trends that should be addressed. Large plants tend to use large (18°F or greater) chilled water ranges to reduce pump and piping sizes and pump work. This in turn requires lower chilled water temperatures to offset the effect on the cooling coils (see *Water Temperatures and Ranges*, page 25).

Figure 52 - Series Counterflow Chillers in P/S Arrangement

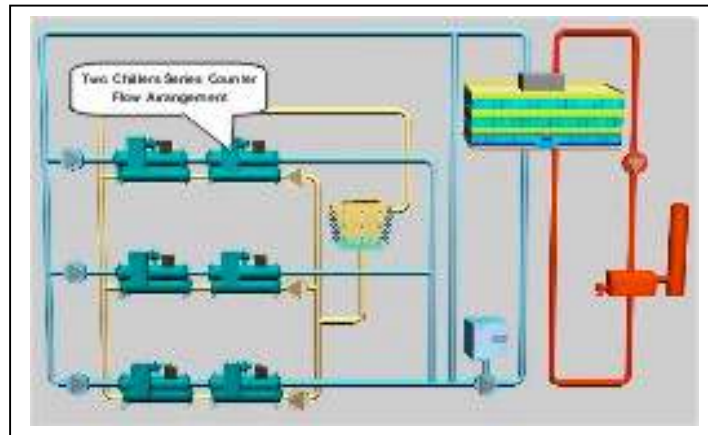

Figure 52 shows series counterflow chillers in a primary/secondary system. The series counterflow arrangement provides an efficient means to produce 40°F supply water with an 18°F temperature range. The series counterflow arrangement can provide about 5% better annual performance than single large chillers when using large temperature ranges.

The primary/secondary arrangement provides variable flow in the secondary loop to reduce pipe and pump size and save pump work.

Primary/Secondary Sequence of Operation

Primary/secondary chiller plant operation can become very complex. It is not unusual to have dedicated and specialized building automation systems to operate the chillers and the ancillary equipment. While a complete discussion on the many ways of operating a complex plant is beyond the intention of this Guide, here are a few key areas to consider:

Condenser Pump and Cooling Tower Operation

Whenever a chiller is on line, there will need to be condenser flow and a means to cool it. With dedicated pumps and towers to each chiller, this is straightforward. They can be operated by either the chiller control panel, assuming it has outputs, or by the BAS. The chiller control panel may offer better performance since it has intimate understanding of the needs of the chiller. Using the BAS to operate the equipment makes the operation easily visible to the control system and to the operator. (For example, without an additional flow sensor, it may not be obvious to the BAS that the condenser pump is operating.) Using either Open Protocol™ or Protocol Selectability™ allows the chiller to operate the equipment while providing easy visibility for the BAS and operator. The information is passed digitally from the chiller controller to the BAS.

When the condenser pumps are shared in a common header the sequence becomes more complex. Automatic isolation valves will be required. If the pumps are all the same size, the BAS must open the valve and start a condenser pump. The pump sequence is usually based on pump run-hours.

When the chillers have different condenser flow requirements, the system becomes very complex. Flow meters may be required.

When a common cooling tower plant is used, a sequence to determine the optimum condenser water temperature is required. Special care should be taken when an absorption chiller is used in a hybrid plant. Generally an absorption chiller has different condenser water requirements than a centrifugal chiller.

Primary Pump Operation

Primary pumps will have similar issues as condenser pumps. Dedicated pumps are straightforward. Common pumps in a headered arrangement are more complex. When overpumping is considered as a solution to low delta T syndrome or to take advantage on additional chiller capacity during low lift situations, the sequence can be very complex.

Secondary Pump Operation

Secondary pump operation in general is covered in *Variable Flow Pumps*, page 13.

Chiller Staging

A critical requirement of primary /secondary systems is that the primary flow always be equal to or exceed the secondary flow. Theoretically this should happen because the chilled water temperature range is constant and the chilled water flow is proportional to the cooling load.

Assuming this happens, chillers could be staged on and off based on their load. However, this is not necessarily a good control scheme. First, Low Delta

© *Tip: It is absolutely necessary for the primary chilled water flow to equal or exceed the secondary flow (See **Low Delta T Example**, page 83). The primary/secondary control system must maintain this flow relationship above all.*

T syndrome can cause a disconnect so the chilled water flow is not proportional to load. (See **Low Delta T Example**, page 80). Just using chiller load will not recognize when this situation occurs. A second issue is the chiller power draw is not an exact indicator of the actual cooling effect. For instance, if there is condenser water relief, the chiller will produce the required cooling effect with less kilowatts. It is even possible for the chiller to produce more than the design cooling capacity with the same kilowatts if there is some form of condenser relief.

Monitoring the chiller power load can be advantageous and can provide some guidance in chiller staging along with other data inputs discussed below. Power monitoring can be accomplished by using communication gateways such as Open Protocol™ or Protocol Selectability or with power meters.

To make sure the primary flow meets or exceeds the secondary flow, the BAS must also monitor chilled water flows. One method is measuring the direction of flow through the decoupler. A flow meter in the decoupler can be difficult due to the short pipe length and low flowrates. It is important that if a flow meter is used, that it actually works and provides meaningful information.

Another method is to measure the chilled water temperature in the decoupler. A single temperature sensor in the decoupler in principle should work. For instance if the temperature is near the supply water temperature setpoint, then flow must be going from the supply to the return (which is what is required). However, if the temperature rises to close to the return water temperature, then the flow must have reversed (which is not desirable). In practice, a single sensor can lead to false readings for several reasons. For example, low delta T syndrome can make the actual chilled water temperature range very small so the BAS cannot tell which way the water is flowing.

A more reliable method is to use temperature sensors in the supply and return piping on both sides of the decoupler. This arrangement allows the BAS to monitor the actual chilled water temperature range at the decoupler. With four sensors, the BAS can monitor that the chilled water temperature

does not rise as it passes the decoupler, that the return water temperature may rise as it passes the decoupler and that the decoupler water temperature is close to the supply chilled water temperature.

Once the situation occurs where there is reverse flow in the decoupler, another chiller and primary pump must be added to keep the chilled water plant operating properly. Using temperature sensors may not provide very much warning.

Another method for staging chillers is to use a flow meter in the chilled water supply line downstream of the decoupler. Using the required flow and the flowrates for each of the primary pumps (These are fixed flowrates), the BAS can monitor that there is enough primary flow for the required secondary flow. This method is very reliable. It can also provide some warning that another chiller/primary pump is going to be required. Normal schedules have the next chiller start when the current chiller has been operating at 90% capacity for 30 minutes. The actual load and time period vary from project to project. Many operators do not want a chiller to automatically start but prefer that the BAS indicate a chiller is required. If the operator acknowledges the start request, the BAS can then enable another chiller.

Optimizing High Part load Performance Chillers

High part load performance chillers such as a VFD or dual compressor chiller may create an opportunity to operate the chiller plant in a different but more efficient manner. These chillers operate more efficiently at part load than at full load. Refer to *Dual Compressor and VFD Chillers*, page 31.

State of the Art Chiller Plant Operation

The previous section provides the basics to get a primary/secondary system to operate satisfactorily. Leading edge control systems are aimed at improving overall system efficiency. To accomplish this, algorithms are developed that model the building load profile and monitor the weather. Three-dimensional chiller models are also used along with matrices for the power consumption of individual ancillary components. The program then simulates the building load and monitors the weather conditions. It evaluates which combination of equipment will use the least power to accomplish the load. In large systems, this additional effort has been shown to pay for itself.

Water-Side Free Cooling

Some HVAC systems (fancoils) can require chilled water year round. Where the weather allows, waterside free cooling can avoid the need for mechanical cooling. Other systems such as floor-by-floor compartment systems can use waterside free cooling and avoid the need for access to an exterior wall.

Direct Waterside Free Cooling

Figure 53 - Direct Water-side Free Cooling

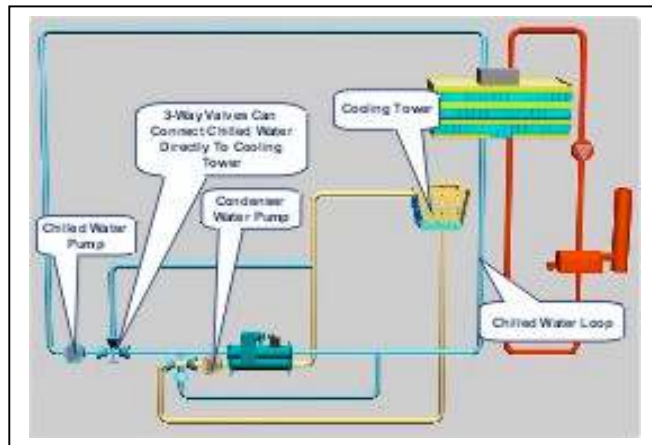

There are several ways to provide waterside free cooling. The chilled water loop can be connected by means of three-way valves, directly to the cooling tower in a “strainer cycle” method. This method is not preferred because the chilled water loop is then exposed to atmosphere introducing dirt and creating water treatment difficulties.

Parallel Waterside Free Cooling

Figure 54 shows a heat exchanger in parallel with the chiller. During free cooling the chiller is off and isolated by valves. The heat exchanger rejects heat into the condenser water loop. For this to happen, the condenser loop must be colder than the chilled water loop (the reverse of chiller operation).

Figure 54, Waterside Free Cooling With Heat Exchanger In Parallel

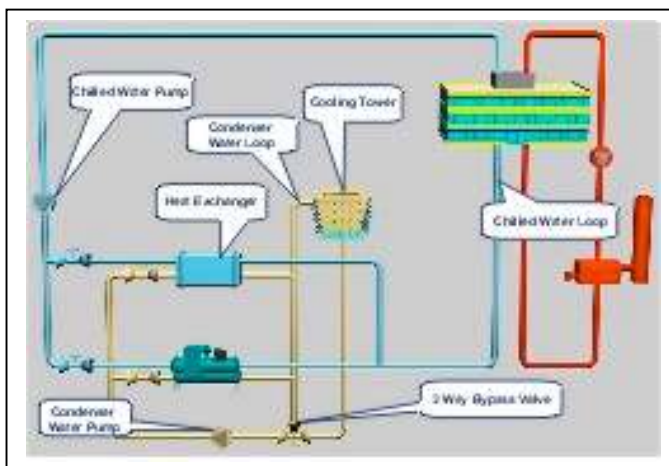

This system is “non-integrated” meaning it can only be either mechanical cooling or free cooling. Nonintegrated systems generally do not offer as much savings as integrated systems but avoid additional operating hours for chillers at light loads. Continuous light load operation for some chillers can lead to operational difficulties such as oil migration or repeated starts.

Series Waterside Free Cooling

Figure 55, Free Cooling in Series with Chillers

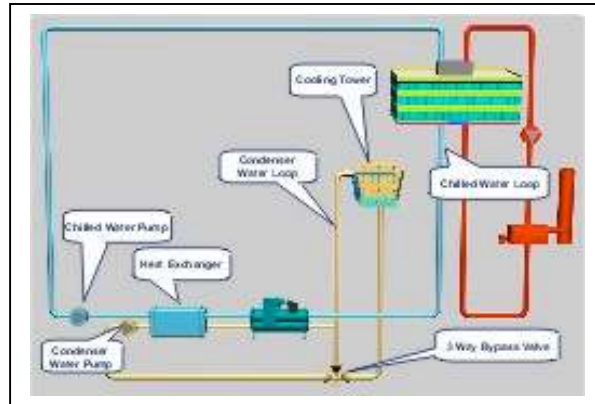

Figure 55 shows a different free cooling arrangement with the chiller in series with the heat exchanger. Since the heat exchanger operates with a higher return chilled water temperature, the operating season is longer than the parallel arrangement, offering more annual savings. This is an integrated system with the chiller “trimming” the chilled water temperature while operating with significant condenser water relief. Because the heat exchanger is piped directly in series with the chiller, the

heat exchanger pressure drop must be overcome whenever the chiller plant operates. ASHRAE Standard 90.1-2001 requires that the pressure drop by 15 ft or less.

Figure 56 – Free Cooling with Tertiary Loop

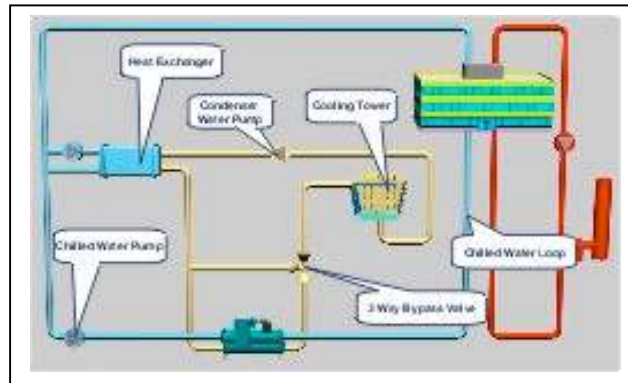

Figure 56 shows a modified version where the heat exchanger uses a small tertiary loop and a dedicated pump. This arrangement removes the heat exchanger pressure drop from the main chilled water system.

Locating the heat exchanger in the main return line allows the heat exchanger to use all the return chilled water flow for all the chillers as a heat source as opposed to just the flow for a single chiller.

Waterside Free Cooling Design Approach

Designing a waterside economizer system requires knowledge of how the building will operate at part load. Variable chilled water flow systems are a better choice than constant flow because they maintain a higher return water temperature, which provides hotter return water temperature for the heat exchanger. The following is one method for designing the system.

- ❑ Calculate the building load at the ambient conditions where free cooling can support the building (changeover point). 50°F db and 45°F wb, this is a common design point since it is the ASHRAE 90.1-2001 requirement.
- ❑ Establish the chilled water supply temperature required by the cooling coils to meet the load at the changeover point. Concentrate on systems serving core load areas. Generally, the only relief these zones see is in the drop in enthalpy of the ventilation air. The goal here is to “trade” the coil capacity used for cooling ventilation air in the summer for a higher supply water temperature.
- ❑ Establish the return water temperature. The return water temperature is required to size the heat exchanger. The conservative solution is to re-rate all the cooling coils with the raised supply water temperature and the reduced cooling loads. Then take weighted average to obtain the return water temperature. A simpler calculation for variable flow systems is to assume the chilled water range will remain the same and the flow will be proportional to the building load at the crossover point. For constant flow systems, the flow will be the same and the chilled water temperature range will be proportional to the load.
- ❑ Select a heat exchanger. The design requirements will depend on which type of arrangement is selected. With a heat exchanger on a tertiary loop as an example (Figure 56), use the following:
 - ❑ The chilled water flow rate at the crossover point.
 - ❑ The chilled water return temperature at the crossover point.
 - ❑ The condenser water design flow rate.
 - ❑ Assume a 2 to 3°F approach for the heat exchanger.
 - ❑ Solve for the entering and leaving condenser water temperature.
- ❑ Confirm the cooling tower can meet the design requirements at a wetbulb of 45°F.

Cooling Tower Sizing

Cooling tower sizing is critical for effective operation during free cooling. Normally, the cooling tower is sized to reject the heat collected in the building plus the compressor work at design conditions. Industry standard conditions are 95°F entering water, 85°F leaving water and 3.0 US gpm with an ambient wetbulb of 78°F.

Figure 57 shows a typical cooling tower performance at industry standard (Cooling Tower Institute or CTI) conditions for different temperature ranges. Following the 10°F range line down to 45°F wetbulb shows the best water temperature available will be 61°F. Add to this a 2°F approach for the heat exchanger and the HVAC system would need to be able to cool the building with 63°F supply chilled water. Once the chiller compressors are removed from the cooling tower load, the new condenser temperature range becomes approximately 8°F. Assuming the cooling load is only 50% by the time the ambient wetbulb has dropped to 45°F, then the temperature range now becomes 4°F. Reviewing Figure 57 for a 4°F range shows the condenser supply water temperature can now be 53°F providing 55°F chilled water. This is still very warm and it will be difficult to properly cool the building.

Figure 57 - Cooling Tower Performance Curve at Standard Conditions

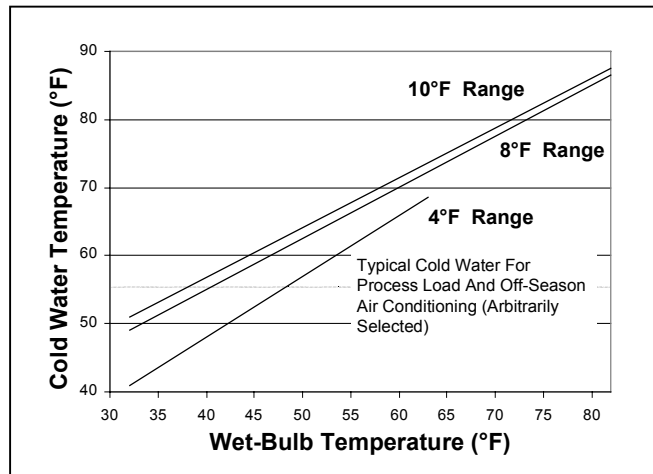

Figure 58 - Cooling Tower Performance Optimized For Free Cooling

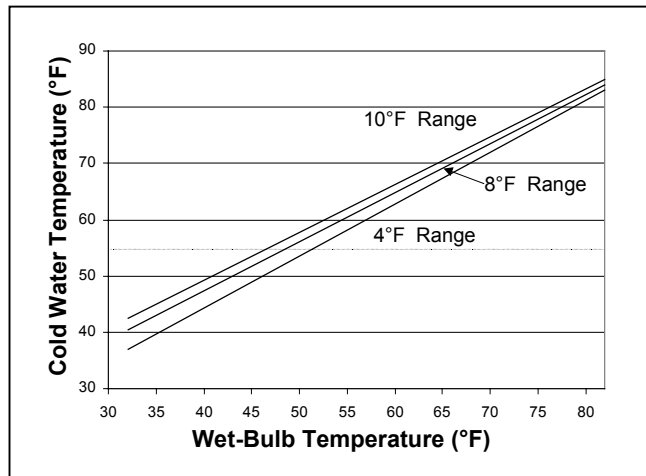

Figure 58 shows a cooling tower optimized for free cooling. The cooling tower was selected to provide 48°F condenser water at a 45°F wetbulb and 4°F range (50% building load). This allows 50°F chilled water to be produced.

At summer design load conditions, the optimized cooling tower can produce 81°F at a 10°F range. Reducing the condenser water temperature 4°F can significantly reduce the cost of the chiller and improve the performance. In most cases the saving will be enough to cover the cost of the larger cooling tower.

Waterside Free Cooling Sequence of Operation

The actual details of the control sequence will depend on which system is selected. There are several parameters, which all the systems have in common. Until the condenser water is colder than the chilled water, there can be no free cooling. During periods when free cooling is not possible, all parasitic energy losses should be minimized. Where possible, remove the heat exchanger from the system pressure drop by means of valves. Shut down any pumps associated with just the heat exchanger.

The cooling tower controls must strive to lower the condenser water temperature as much as possible. Condenser water much colder than about 65°F is too cold for a chiller. Any kind of integrated system must involve some sort of head pressure control such as a three-way bypass valve around the chiller. Once the cooling tower can no longer provide condenser water cold enough to perform any free cooling, the cooling tower control logic should change to optimize the chiller performance rather than the heat exchanger.

Many buildings go into night setback during unoccupied hours. When the building returns to occupied operating mode, the chiller plant can attempt to use free cooling. If non-integrated free cooling cannot meet the load, then mechanical cooling will be required.

A key issue is the transition from free cooling to mechanical cooling. Once the building load cannot be met by free cooling, the chiller will need to be started. At that point, the condenser loop will be cooler than the chilled water loop, which is “backwards” from the chiller point of view. To allow the chiller to operate, a cooling tower bypass line and valve is required. The modulating bypass valve around the chiller will allow the chiller to raise the condenser loop temperature quickly and minimize the condenser water volume (thermal mass). Most chillers can control the three-way valve directly. Alternatively, the BAS can modulate the valve to reach a minimum of about 65°F as quickly as possible.

An issue with modulating the condenser flow through the chiller is the condenser flow switch will not “see” flow and this will shut down the chiller on a safety. One method to resolve this is to wire a refrigerant head pressure switch in parallel with the condenser flow switch. Below the minimum acceptable head pressure, the switch should “make” or close. Above the minimum head pressure, the switch should “break” or open. The result will be at low head pressure the head pressure switch will be closed and the flow switch will be overridden. Once there is enough head pressure, the head pressure switch will open and the flow switch can monitor the flow.

☺ *Tip: The transition from free cooling to mechanical cooling requires raising the condenser water temperature to about 65°F as quickly as possible. The best method is to use a modulating three way valve around the chiller and have the heat from the chiller raise the condenser water temperature as quickly as possible.*

While in free cooling mode, colder chilled water can produce colder supply air. In VAV systems this can lower the supply air volumes and save fan work. For constant volume systems, colder air is of no value and the minimum chilled water temperature should be the summer design supply water temperature. Once this temperature is reached, the cooling tower fans should modulate to maintain the chilled water temperature and save tower fan energy.

Maintaining the condenser water temperature above freezing conditions is also important. The cooling tower fans should be staged off to maintain the condenser water temperature at 35°F minimum.

Economizers and Energy Efficiency

The goal of either air or waterside economizers is to reduce energy usage. Economizer energy analysis requires annual energy analysis. Airside economizers should be used where possible since in all but the driest climates, airside economizers are more efficient than waterside economizers. An exception to this is where high levels of humidification are required since humidification is expensive and introducing large amounts of outdoor air for cooling would add to the humidification load.

ASHRAE Standard 90.1-2001 requires the following for economizers:

- ❑ Each cooling system with a fan requires either air or waterside economizers. There are many exceptions (6.3.1). Table 6.3.1 in Standard 90.1 lists the minimum system size for which an economizer is required. The table is based on ambient wetbulb and drybulb conditions plus the hours of operation. Weather data is provided in an appendix.
- ❑ One exception is the use of condenser heat recovery for service water heating (6.3.1.d)
- ❑ Waterside economizers must be able to meet the entire building load at 50°F db and 45°F wb and below. (6.3.1.2.1) There is an exception where dehumidification requirements cannot be met.
- ❑ Precooling coils and heat exchangers in line with the chilled water loop cannot exceed 15 ft. water pressure drop. (6.3.1.2.2)
- ❑ Economizers must be integrated (6.3.1.3). There is an exemption for locations with less than 800 hours between 8 a.m. and 4 p.m. where the ambient drybulb temperature is between 55°F and 69°F.

Hybrid Plants

Figure 59 - Gas Fired Absorption Chiller



Mixing and matching different chiller types increases the designer’s option in chiller plant design. To meet small winter chilled water loads, an air-cooled chiller might be included in the chiller plant. The operator does not have to run the cooling towers in winter and the chiller is properly sized for the winter load. This is common in health care applications with water-cooled equipment (MRIs, linear accelerators, etc.) The air-cooled chiller must be properly selected for winter operation.

To diversify the chiller plant on energy sources, an absorption chiller is often incorporated into the chiller plant design. The absorption chiller can operate on either plant steam or directly on

natural gas or #2 fuel oil. Either type allows the operator to shave demand peaks for the electrical load. The absorption chiller can be in series or parallel (primary/secondary) with the electric chiller.

Chilled Water Requirements

Absorption chillers are not as flexible as centrifugal chillers in terms of chilled water flow rates and supply water temperatures. Since the supply temperature and range must be the same in any parallel chiller arrangement, the absorption chiller limitation may set the design.

In a series application, the absorption chiller can be upstream of the electric chiller. The warmer return chilled water improves the efficiency of the absorption chiller by as much as 30%. This arrangement automatically base loads the electric chiller. Until the return water reaches 49°F, the absorption chiller won’t operate. Once the building load climbs above 50%, the electrical demand is avoided by using the absorption chiller. In colder weather, either chiller can be operated. (reset the absorption chiller setpoint to 44°F).

Condenser Flow Requirements

The condenser water needs of the absorption chiller are different from the electric chiller. The electric chiller typically operates with 3 gpm/ton on the condenser side, whereas an absorption chiller operates with higher flow rates. Table 7 lists the ARI typical flow rates for various types of chillers. Condenser water temperature stability and reset are also more critical with an absorption chiller. In addition, absorption chillers may require condenser water flow after the chiller is shut down, for as much as 30 minutes, to cool the machine and avoid crystallization.

Table 7 - ARI Design Condenser Flow Rates

Chiller Type	STD	Condenser EWT (°F)	Condenser Flow Rate (US gpm)
Vapor Compression Chillers	ARI 550/590-98	85	3.0
Single Effect, Indirect Fired Absorption Chiller	ARI 560-2000	85	3.6
Double Effect, Indirect Fired Absorption Chiller	ARI 560-2000	85	4.0
Double Effect, Direct Fired Absorption Chiller	ARI 560-2000	85	4.0

Dedicated cooling towers and condenser pumps are straightforward. If a common cooling tower or headered condenser pumps are being used, then the design has to account for the different design requirements for electric and absorption chillers. One possibility might be to have the absorption chillers selected with the same flow rate per ton as the electric chillers. McQuay absorption chillers can be modified to operate with up to 15°F range with only minor performance changes. This change will make it easier to have the condenser pumps interchangeable.

Heat Recovery and Templifiers™

General

Chiller plants collect all the energy released in the building. In addition, there is an additional 25% more energy from the chillers themselves. This represents a lot of heat that can be used for other processes within the building. The challenge is the heat is in a very low-grade form. It is difficult to find many uses for 95°F condenser water. The solution is to use either heat recovery chillers or Templifiers™, which can raise the water temperature.

Common uses for heat recovery water are:

- HVAC system reheat
- Domestic hot water
- Snow melting
- Process applications

Load Profiles

A key issue with heat recovery is to understand the load profile of the chiller plant and the load profile of the system that requires the heat. *It is absolutely necessary to have a cooling load at the same time there is a requirement for heat.* While this may seem obvious, many reheat systems are designed to use heat recovery hot water when the chiller plant is producing little or no heat.

Figure 60 - Cooling Load vs. Heating Load Profile

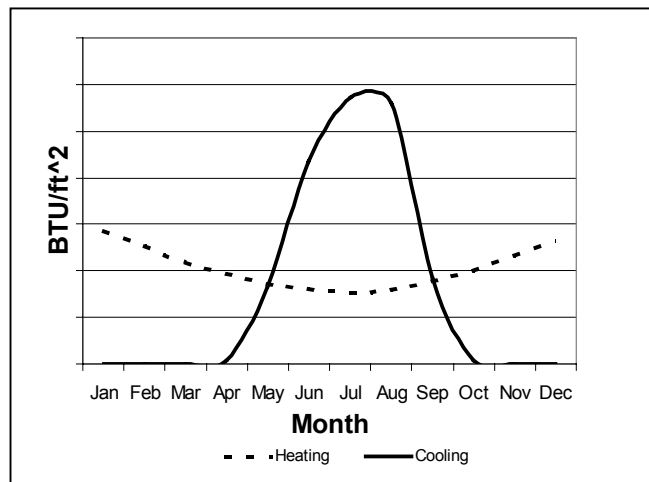

In many cases the cooling load is declining as the heat load is increasing. An example is reheat for VAV. Without a cooling load, no heat can be collected. An analysis must be performed to identify the size and time of heating load. McQuay Energy Analyzer™ can perform the analysis and recommend heat recovery, Templifier™ and source chiller sizing. Then the cooling load at the same time periods must be identified. Some or all of the heat from the cooling load can be used for the heating load.

HVAC systems that require winter chilled water such as fancoils, buildings with process loads, etc., tend to be good candidates for a heat recovery chiller because of the large amount of time when there is simultaneous heating and cooling.

Heat Recovery Chillers

There are two types of heat recovery chillers. Both can produce condenser water from 105 to 115°F rather than the normal 95°F. Figure 61 shows the piping arrangement for a single condenser heat recovery. Typically a heat exchanger is used to transfer the heat from the condenser loop into the hot water loop. This is done to avoid contamination from the open tower condenser loop entering the hot water loop. Using a heat exchanger introduces another approach into the system since the condenser water will have to be about 2°F warmer than the hot water loop.

Figure 61 – Single Condenser Heat Recovery

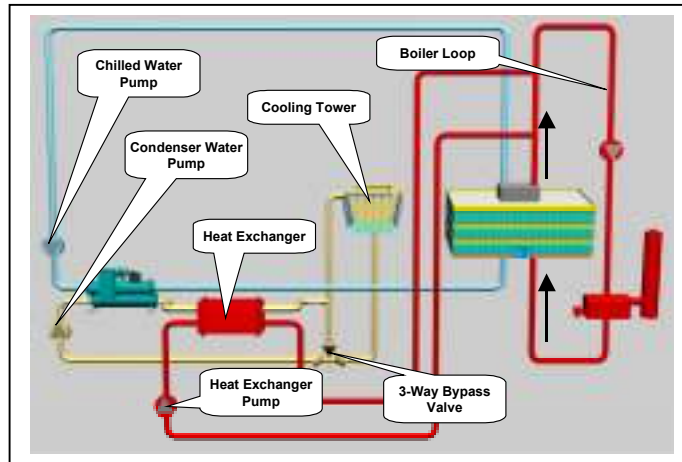

The second type has an additional condenser shell that allows the rejected heat to be rejected to a separate heat recovery water loop. Since the hot water loop is heated directly by the refrigerant, warmer water is possible for the same condensing pressure (compressor work) than with single condenser recovery.

When heat recovery is not required, the condensing pressure can be lowered and the heat rejected to the cooling tower at the typical condenser water temperature range. This reduces the compressor work and improves the chiller efficiency. It is recommended that the chiller has a dedicated cooling tower rather than a common cooling tower with other chillers in the plant. This will avoid raising the condenser water to the other chillers and lowering their performance unnecessarily.

When heat recovery is not required, the condensing pressure can be lowered and the heat

Figure 62 - Split Condenser Type Heat Recovery

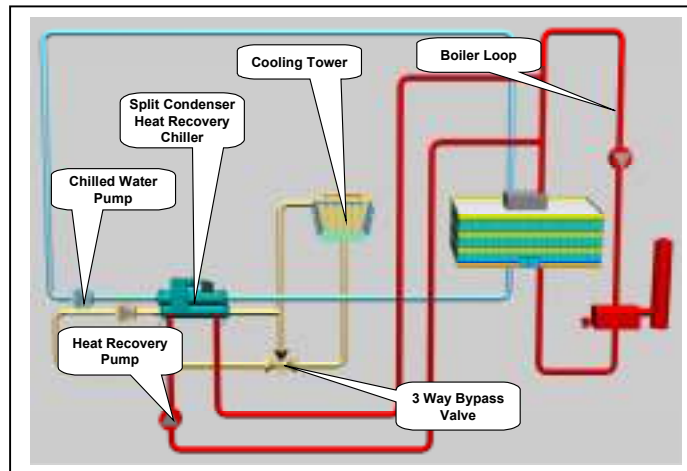

Figure 62 shows the piping arrangement for a split type heat recovery chiller. The hot water loop flows directly through the chiller. Any additional heat not used by the hot water loop is collected in the condenser loop and rejected by the cooling tower.

Split condenser chillers are more expensive but avoid the heat exchanger and other piping requirements.

Heat recovery puts additional demand on either type of heat recovery chiller. To raise the refrigerant condensing temperature high enough to produce the hotter water, the compressor must work harder. This lowers the chiller efficiency and must be taken into account when evaluating the use of heat recovery. Even when the chiller is operating in “normal” mode, the chiller efficiency will be less than a standard chiller because it is not optimized for the lower lift application.

Another major issue is part load performance. As a centrifugal chiller unloads, it becomes more and more difficult for it to produce high lifts. If the lift of the chiller is exceeded, it will stall and then surge, which can severely damage the compressor. Most heat recovery load profiles increase the heating requirement as the cooling load reduces, setting up a situation where the chiller will be partially loaded but expected to produce hot water.

To remedy the problem, hot gas bypass should be included with any heat recovery chiller. While this will protect the chiller from surging, it may also waste a lot of power. For instance, if the hot gas valve opens at 25% capacity, any output between 0 and 25% capacity will consume the power used at 25% capacity. In short, the chiller may become a very large electric resistance heater!

Heat Recovery Chiller Control

When a chiller is in heat recovery mode, it attempts to produce hot water as well as chilled water. There are two common methods of control. The first is for the chiller to maintain a common condenser return water temperature. For example, consider a chiller that is intended to produce 105°F supply hot water with 95°F return hot water at full load. This control sequence will attempt to maintain the return water temperature at 95°F. The supply hot water temperature will then fluctuate between 95 and 105 °F depending on the amount of heat rejected.

Figure 63 - Heat Recovery Chiller Control Options

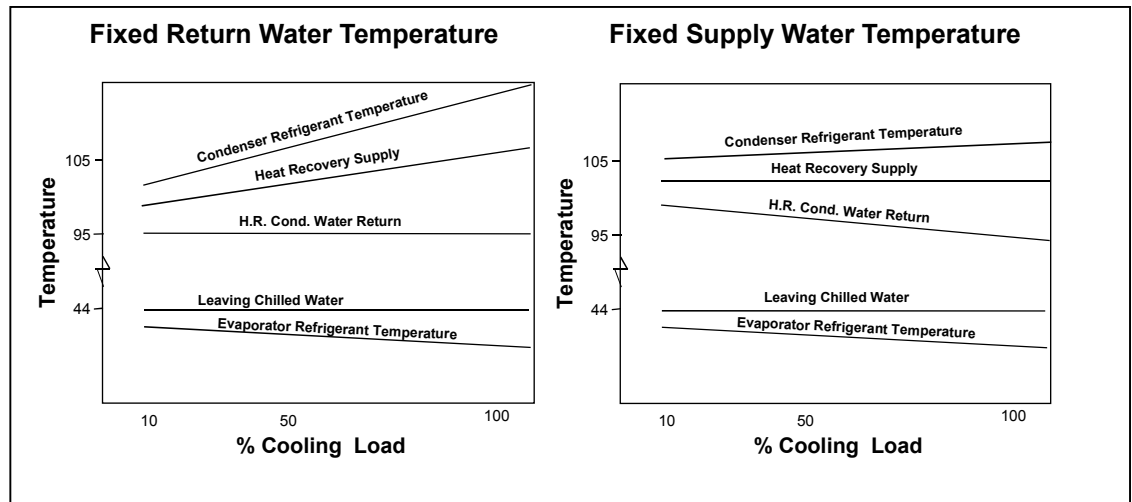

Basing the control on the return water temperature is easier on the chiller in terms of light load lift. During period of light cooling load, the required condensing pressure drops as shown in Figure 63. This reduces the chance of a surge or stall situation and reduces the use of hot gas bypass. A fixed return hot water system (during heat recovery mode) will mean the supply hot water temperature fluctuates as the heating load changes (assuming a constant hot water flow rate. The changes are generally small (3-5°F). The boiler can supplement the heat recovery and add enough heat to maintain the return water temperature. The boiler control should be set up to provide 95°F return water during heat recovery. If desired, during non-heat recovery heating mode, the boiler can operate on a fixed (e.g. 180°F) supply water temperature.

A second control arrangement is for the chiller to attempt to maintain a fixed supply hot water temperature. This arrangement provides, where possible; a constant supply temperature (105°F for example) for the hot water system. It also requires the chiller to produce design condition refrigerant condensing pressures even at very low chiller loads. This arrangement is harder on the chiller and will generally produce less heat recovery than a control system that maintains a constant entering water temperature.

Raising the hot water temperature is accomplished through cooling tower and bypass valve control. To raise the water temperature for either single shell or split shell heat recovery, either the cooling tower or the chiller bypass valve must be modulated to meet the required hot water temperature. (The cooling tower water temperature will be the same as the hot water temperature!) Normal cooling tower operation is overridden. When there is no heat recovery required (no heating load) the control system should lower the condenser water temperature and follow whatever control sequence is being used for conventional chillers (See *Cooling Tower Controls*, page 18).

Heat Recovery Chiller Selection

Proper heat recovery chiller selection requires a clear understanding of the chilled water and hot water load profiles. To produce the best results, the chilled water plant design should be optimized to take full advantage of the load profiles. A common practice is to design the chilled water plant as if there was no heat recovery and then pick one of the chillers and rate it as a heat recovery chiller at design

cooling load conditions. The total heat of rejection from a heat recovery chiller operating at design cooling is 1.25 times the design cooling capacity. While this sounds like a significant amount of energy recovery, it does not mean the system will *actually* produce it. The chiller will only produce this amount of heat recovery if it is fully loaded and all the other design parameters are met. The following issues should be considered when selecting a heat recovery chiller:

- ❑ **Chiller Sizing.** The chiller should be sized as close to the expected cooling load during heat recovery as possible. It is important to have the chiller operating as close as possible to 100% cooling load during heat recovery to provide the best refrigerant lift and to use the least amount of hot gas bypass. The optimal size requires annual energy analysis. McQuay's Energy Analyzer™ can provide the analysis and recommend a heat recovery chiller size.
- ❑ **Hot Water Temperature Ranges.** Chillers are typically selected based on 10°F ranges while hot water systems are often designed for 20°F ranges. Using 20°F ranges for the chiller are not recommended. Using tertiary piping for the chiller on the hot water loop allows the chiller to be on a different temperature range and the pressure drop of the chiller is avoided when not in use.
- ❑ **Hot Water Supply Temperature.** Heat recovery chillers are limited in what they can produce. The higher the water temperature, the more useful it is for heating. However, high supply water temperatures are harder on the compressor, reduce the stable compressor envelope and lower the chiller performance.
- ❑ **Boiler Interaction.** It is easy to become fixated on maintaining the hot water supply setpoint when the real goal is to produce as much heat recovery as possible. Understand how the boiler and chiller interact to produce hot water. Try to collect as much heat as possible from the chiller (even if the supply water temperature is not met) and trim with the boiler to meet the required heating load.
- ❑ **Compressor Lift Limitations.** The higher the compressor lift requirement, the smaller the stable compressor envelope, and the sooner the compressor lift will be exceeded at part load. Understand at what percentage of cooling load the compressor will no longer maintain the required lift. Operation below this point will require hot gas bypass. Select the hot water control sequence that produces the best result. Basing the hot water control on the return water temperature may produce more heat recovery without hot gas bypass.

Chilled Water Plant Design for Heat Recovery

Any chiller plant design can include a heat recovery chiller. Generally, only one chiller in a multiple chiller plant is a heat recovery type. It should be the first chiller that is activated during cooling. Another design possibility is to add a heat recovery chiller with a tertiary loop, in the chilled water return line. This chiller will reduce the load on the main chillers by lowering the return water temperature. It will also allow all the heat recovered in the building to be available for heat recovery.

Chiller plant design can be “tuned” to optimize heat recovery. Here is a list of things to consider:

- ❑ Pick a chiller size that matches the chilled water load during heat recovery.
- ❑ Backload the chiller by the placement of the decoupler (See *Decoupler Location*, page 54).
- ❑ Consider series chillers where the upstream chiller is the heat recovery chiller.
- ❑ Use chilled water reset so the lift is reduced during heat recovery operation.
- ❑ Evaluate a VFD chiller, which will operate more efficiently when not in heat recovery mode.
- ❑ Avoid low chilled water design temperatures.

Impact on the Rest of the HVAC Design

Where heat recovery will be used for heating, the chiller should tie into the boiler return. A tertiary loop is recommended so the chiller heat recovery temperature range can be different than the boiler loop range. The flow rates for the boiler and the heat recovery will mostly likely be different as well.

A tertiary loop also allows the pressure drop through the heat recovery chiller to be avoided when heat recovery is not possible.

Most heating systems are designed for 170°F average water temperature. The use of heat recovery will require the heating system to operate with water in the 105 to 115°F range. Whereas single row heating coils in terminal heating units would have worked with a conventional design, now 3 or 4-row heating coils may be required. These coils will add to the capital cost of the project. Further, they will increase the fan static pressure drop every hour the fan system operates.

Domestic hot water systems range from 120°F for showers, baths, etc to 140°F for kitchens. These temperatures exceed the capabilities of a heat recovery chiller, however, a heat recovery chiller can be used for preheat. When heat recovery is used for domestic hot water, local codes may require an isolating heat exchanger.

Templifiers™

A Templifier™ is a water-to-water energy recovery device. It is capable of producing hot water in the 140 to 160°F range with a COP between 3 and 5.

Figure 64 – McQuay Templifier™



Templifiers™ can be used in any application where heat recovery chillers are considered, as well as in many other applications where hotter water is required than can be produced by heat recovery chillers. Other applications include geothermal, solar collectors, ground source and closed loop water source heatpumps.

Figure 65 shows a Templifier™ used in a chiller plant system. In this arrangement the Templifier™ can produce 140 to 160°F from the heat of rejection of Chiller 1. It can do this while still allowing normal condenser relief for Chiller 1.

Figure 65 - Templifier™ in a Condenser Loop

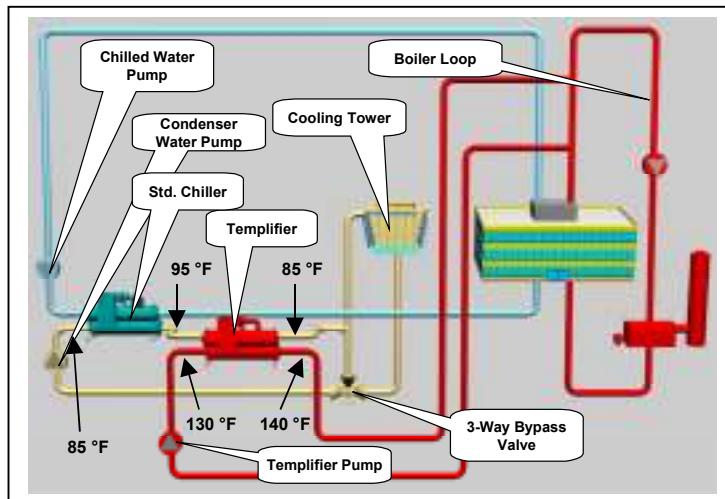

Templifier™ Control

Templifiers™ are designed to maintain the heating water setpoint regardless of source water conditions within the limits of the machine.

Templifier™ Selection

Templifier™ size should be based on the heat load and the source chiller total heat of rejection. The best method

for selecting the capacity is to perform an annual analysis and identify the balance point where the heat source and the heat load are largest. This can be a very involved calculation requiring several iterations. The McQuay Energy Analyzer™ can perform this annual analysis and provide a recommended Templifier™ and source chiller size. The following are some alternative methods that can be used as a starting point to evaluate a design:

- ❑ If the intent is to provide reheat for a VAV system, use the design reheat load from the building winter design load calculations. This will be enough heat to raise all the supply air from 55°F to 75°F with the VAV boxes at minimum flow. Assume the cooling load will be 50% of design. If there are two equally sized chillers, then the source chiller will be fully loaded. The Templifier™ capacity should be the smaller of these two loads.
- ❑ For a constant volume system, do the same as above but use the summer design reheat. Constant volume with reheat systems use large amounts of reheat even in warm weather.
- ❑ Fancoil systems offer an excellent opportunity since there is such a large overlap in heating and cooling loads. Use the lesser of either the winter building envelope heat loss (less the ventilation air) or the source chiller capacity times 1.25 for the chiller compressor work.
- ❑ For domestic hot water applications use the smaller of either the 50% of the chiller design load or the design domestic hot water load.

Templifiers™ are selected based on the leaving heating water temperature and the leaving source water temperature. In most cases, the designer knows the desired heating water temperature and the entering source water temperature at building design conditions (For condenser water heat recovery, this would be the condenser water temperature leaving the chiller). It is important to select the Templifier™ based on the most demanding conditions expected during heat recovery. It is recommended that the minimum entering condenser water for the chiller supplying the heat be set at 65°F. Assuming the chiller is operating at 50% capacity during heat recovery mode, the supply water temperature to the Templifier™ would be 70°F (based on a 10°F range for the condenser water).

The more source flow through the Templifier™, the warmer the leaving source water temperature will be. When there is additional source flow available, it is recommended that the flow through the Templifier™ be increased until the design temperature range is 5°F or the design flowrate is 4.8 US gpm/ton. Using the source supply water temperature and the Templifier™ load, the source leaving water temperature can be calculated. More information on selecting Templifiers™ can be found in McQuay product catalog *PM Templifier*.

Chilled Water Plant Design for Templifier™ Heat Recovery

Templifiers™ can use the condenser water of any chiller for a heat source. In some applications, it may make sense to change the source chiller size to optimize heat recovery. It should be the first chiller that is activated during cooling. A common condenser water loop for all the chillers in the plant allows all the heat rejected by the chiller plant to be used for heat recovery by the Templifier™. Preferentially loading the source chiller by the placement of the decoupler (See *Decoupler Location*, page 54) can also increase the heat available for recovery.

Templifier™ Impact On the Rest Of the HVAC Design

Where heat recovery will be used for reheat, the Templifier™ should tie into the boiler return. A tertiary loop is recommended so the Templifier™ temperature range can be different than the boiler loop range. The flow rates for the boiler and the Templifier™ will mostly likely be different as well. A tertiary loop also allows the pressure drop through the Templifier™ to be avoided when heat recovery is not possible.

Most heating systems are designed for 180°F average water temperature. A Templifier can provide 140 to 160°F water, which is typically enough to provide reheat during the spring and fall periods without having to increase the size of reheat coils. During the winter season, the hotter water from the boiler can be used for the larger loads experienced by the reheat coils. The reheat coils should be sized for the winter load and boiler design supply temperature.

Domestic hot water systems range from 120°F for showers, baths, etc to 140°F for kitchens. The Templifier can supply water at these temperatures. When heat recovery is used for domestic hot water, local codes may require an isolating heat exchanger.

ASHRAE Standard 90.1

ASHRAE Standard 90.1 makes several references to condenser heat recovery. Here is a list of items:

- ❑ There is a requirement for condenser heat recovery to be used to preheat domestic hot water for;
 - ❑ Facilities open 24 hours a day.
 - ❑ Total heat of rejection from the chiller plant is 6,000,000 Btu/hr or greater (About a 400-ton plant).
 - ❑ Domestic hot water load exceeds 1,000,000 Btu/hr.
 - ❑ The system must be able to either use 60% of the chiller peak rejection load at design conditions or preheat the domestic hot water to 85°F. (6.3.6.2)
- ❑ There is an exemption for the requirement for economizers if condenser heat recovery is used for domestic hot water. (6.3.1d)
- ❑ There is an exemption for simultaneous heating and cooling if 75% of the energy used for reheat comes from energy recovery such as condenser heat recovery. This can be helpful with some VAV with reheat designs. (6.3.2.1c)
- ❑ There is an exemption for pool covers for pools heated to 90°F if 60% of the heat comes from site recovered energy.

Heat Recovery and Templifier™ Example

Consider an acute care hospital in Chicago. The facility is 480,000 ft², 3 story with a 1600 ton chiller plant and a 22,000 mbh boiler plant. The air system is constant volume with reheat. Constant volume with reheat is common in health care because the air turnover rates are specified. This system requires reheat year round.

Let's compare a base building (no energy recovery) with Templifier™ and a split condenser heat recovery chiller. The base building uses two 800 ton dual compressor centrifugals. The Templifier™ version has a 472 ton unit with a 4.4 COP. It is providing hot water at 140°F. The source chiller condenser pump head was increased by 20 ft since there are two chiller barrels in series. The heat recovery version has a 400 ton Heat recovery chiller producing 105°F hot water at 0.73 kW/ton. The second chiller is a 1600 ton dual compressor centrifugal. The supply fan static pressure was increased 0.20 inches to off set the deeper coils required by the low hot water temperature.

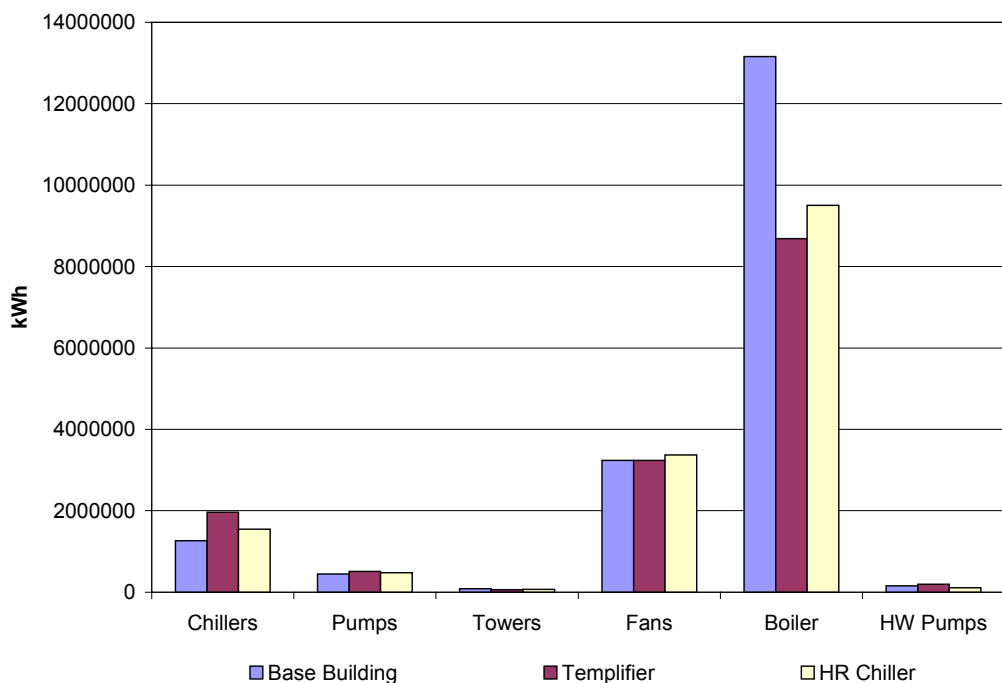

The graph above was generated from data produced by Energy Analyzer™. The chiller work increased when energy recovery was added. The Templifier™ penalty was the highest, however it produces the warmest hot water. The pump work was higher for the Templifier™ example because the condenser pump head was increased. The two heat recovery examples saved tower fan work since less energy was being rejected but the savings are minor. The heat recovery chiller example saw a 4% increase in fanwork due to the increased static pressure. Both heat recovery examples saved significant boiler work. The Templifier™ savings are greater because all the Templifier™ compressor work can be subtracted from the boiler load. Both heat recovery options require an additional circulating pump that operates when in heat recovery mode.

Overall, both heat recovery options saved over 6 million kBtu/year. The annual operating savings for the Templifier™ is \$108,000 over the base building. Both heat recovery options have less than 2 year paybacks and offer 80% Return on investment.

Variable Primary Flow Design

Modern DDC controllers on chillers allow the possibility of variable flow design. Traditional thinking has been that the chiller should see constant flow and then the load will vary directly with the return fluid temperature. Allowing variable flow means the cooling load can vary either with the return fluid temperature or a change in the chilled water flow. It requires modern controllers to deal with two variables and provide stable chiller operation.

Basic Operation

Figure 66 shows a two chiller variable primary flow system. Variable primary flow can be applied to single, parallel or series chiller plants although parallel is the most common. The control valve at the cooling loads are two-way type so the chilled water flow varies with the cooling load. The primary pump for the chillers circulates the chilled water throughout the building. The chilled water flow varies through the chillers as well. This is the main difference between variable primary flow and primary/secondary flow.

Figure 66, - Basic Variable Primary Flow Operation

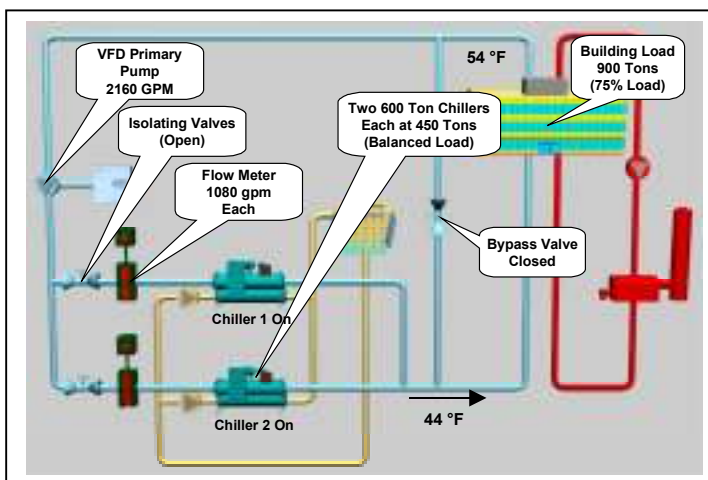

Variable primary flow provides pump savings over primary secondary systems because all the chilled water being pumped is being used for cooling. In a primary /secondary system, any flow through the decoupler consumes pump power but provides no cooling.

There is a bypass line to maintain minimum flow through the chillers only. Whenever the chilled water flow is above minimum, the bypass is closed.

Basic Components

Figure 67 - Variable Primary Flow System

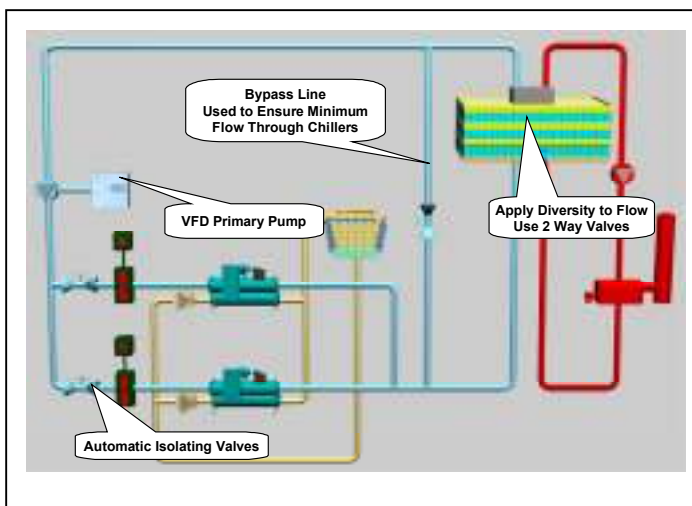

Chillers

Almost any type of chiller can be used including air-cooled and absorption. The chiller must have a unit controller capable of dealing with both a change in flow and a change in return temperature. In most cases, the controller should be a modern digital type using PID control loops. Check with the manufacturer whether the controller is capable of variable primary flow. Usually, the controller can be upgraded on an existing unit if required.

The range of flow rates in the chiller is limited at the low end by laminar flow in the tubes (2 to 3 fps tube velocity) and at the high end by tube erosion and vibration (10 to 12 fps tube velocity). Chiller selection software typically tries to pick a tube velocity of around 6 fps which provides a good balance between water pressure drop and heat transfer performance. Half the typical design flow rate will result in 3 fps tube velocities which is about the minimum. The actual minimum should be provided by the manufacturer and is often included in computer selections.

Selecting the chiller with tube velocities at design conditions near 10 fps allows the system flow to be turned down to 30% of design flow. This may be advantageous where there is only one chiller in the system with few operating hours at design flow.

© *Tip: Usually, the minimum flow rate of a chiller is 50% of the design flow rate. This value can be used to size the bypass line. The bypass line should be capable of handling the minimum flow of the largest chiller.*

In most cases, the chillers will be the same size. The flow ranges and capacities must be carefully considered so that there are no operating points where no combination of chillers can meet the load. For example, if two evenly identical chillers have a minimum flow rate 60% of design, there will be a “hole” between 50 and 60% of plant capacity. One chiller can meet the load up to 50% of plant capacity. However, at say 55% two chillers will be required but the flowrate will be less than the minimum required. Careful chiller selection (preferred since it is more energy efficient) and the use on the bypass will resolve this problem.

Pumps

The chilled water pump is variable flow. (See *Variable Flow Pumps*, page 13). They are sized to provide enough head to circulate chilled water throughout the building. Automatic isolating valves are provided in front of each chiller to stop flow when the chiller is not operating. Pumps can be dedicated to each chiller or in the main return line (as shown in Figure 67). Common pumps allow overpumping and sharing a spare pump.

Bypass Line

The bypass should be sized for the minimum flow rate of the largest chiller being used. It is only used to provide minimum flow to a chiller when the flow requirement through the chiller plant is less than the chiller minimum flow.

The bypass line can be located between the chillers and the loads (as shown in Figure 67). This is the same location as a decoupler in a conventional primary/secondary system. The bypass line could also be placed at the end of the cooling loop. The bypass control valves will see a smaller pressure drop but there may be some additional pump work.

Alternatively, some cooling loads could use three-way valves, which would provide the minimum flow required. On the other hand these valves will bypass chilled water any time they are not operating at design load, which wastes pump work and leads to low delta T syndrome.

When flow is required through the bypass line, it must be controlled. A modulating two or three-way valve is required.

Variable Primary Flow Sequence of Operation

Although a variable primary flow system is no more difficult to design than a primary/secondary system, the control sequences must be carefully thought out and commissioned. A building automation system (BAS) capable of variable primary flow is a must. Direct communication between the BAS and the chiller unit controllers is strongly recommended as well. This can be accomplished with controls communication (McQuay Protocol Selectability™, for example) using industry open, standard protocols such as BACnet® or LonTalk®.

Primary Pump Control

The primary pump is controlled in the same manner as a secondary pump in a primary/secondary system (Refer to *Variable Flow Pumps*, page 13).

Modulating both the flow and temperature range through a chiller requires time for the chiller controller to respond. Many factors influence the rate of change of flow including the chiller type, the chiller controller logic and the actual load on the chiller at the time. Some field adjustment of the rate of change time should be expected during commissioning. A good starting point is 10% change in flow per minute. This will effect the modulating rate of the primary pumps and the terminal unit control valves.

Bypass Line Valve Control

It is recommended that each chiller should have a flow meter. The meter can be used to recognize both minimum and maximum flow constraints. Individual chiller meters allow each chiller's flow rate to monitored, which may be advantageous in some chiller plant control concepts such as overpumping or deliberately operating multiple high part load efficient chillers in lieu of a single chiller.

It is possible to use only one flow meter in the common chilled water supply line upstream of the bypass line. Assuming only one chiller is operating when minimum flow becomes an issue, the flow measured at this point would be the flow through the operating chiller.

The bypass line control valve is controlled by a signal from the flow meter of the operating chiller. The control system should recognize the chiller and know the minimum flow rate for that chiller. In most cases the chillers are all the same and hence there is only one minimum flow rate for the entire chiller plant. The bypass line control valve is modulated to maintain the minimum chiller flow. This must be done slowly. Fast changes in the bypass line flow may cause the primary pump control loop to hunt as it recognizes a change in total chilled water flow.

Starting an Additional Chiller

The first step is recognizing an additional chiller is required. The BAS can use the individual chiller flow meter and the chiller load as indicators that another chiller is required. Another chiller is required when either the chiller capacity or the chiller design flow rate has been reached.

Using the maximum flow rate rather than the design flow rate will “overpump” the chiller. The pressure drop will exceed design conditions and increase the primary pump work. The advantage is starting another chiller and its ancillary equipment (condenser pump, cooling tower etc) is staved off. This is a good method for counteracting low delta T syndrome.

A different approach is to use chillers with excellent part load performance and deliberately operate multiple chillers at part load. Refer to *Low Delta T Syndrome*, page 84.

Adding a chiller is more complicated than other chiller plant systems as explained in the example below. Each chiller must have an automatic isolating valve. When the chillers are all the same size, the valves can be two-position type. These valves must open and close slowly.

Adding a Chiller Example

In a two-chiller variable primary flow system, the first chiller is operating at 100% load. The plant load increases so that a second chiller is required. At this moment, all the chilled water is flowing through the operating chiller, which is cooling the chilled water from 54°F to 44°F.

To start the second chiller, the building automation system will open the isolating valve for the second chiller. If done quickly, the operating chiller will see the flow rate cut in half. At 100% capacity, the operating chiller will effectively double its chilled water temperature range so that the supply water temperature will become 34°F! The chiller controller will start to respond to the sudden change in load but will most likely trip on a freeze or low pressure safety.

To reduce the possibility of a nuisance trip, the following sequence is recommended. Prior to opening the isolating valve on the chiller to be started, use either the demand limiting feature or some form of controls communication (McQuay MicroTech II™ control's Protocol Selectability™ for example) to reduce the capacity of the operating chiller(s) to 50%. Next, slowly open the isolating valve on the chiller to be started. Enable the added chiller and allow it to start. Release the demand limiting on the original chiller(s). During the chiller startup, accurate chilled water supply temperature control will be lost for a few minutes. In most HVAC applications, this is acceptable. For close tolerance designs, a different concept may be required. There are other methods for adding chillers. The goal is to add the chiller and avoid a nuisance trip or damage to the equipment.

Shutting Down a Chiller

A chiller can be shut down when the sum of the chilled water flows through all the operating chillers is less than the design capacity of the remaining chiller(s). If the concept of using two efficient part load chillers rather than one conventional chiller is being used, then different criteria will be required.

To shut down a chiller, the chiller is commanded off by the BAS. Once the chiller is off, its isolating valve is slowly closed. It is important to provide some time for the remaining chillers to ramp up to the additional load.

Variable Primary Flow with Different Sized Chillers

Using different sized chillers (and hence different chilled water flow rates,) in a variable primary flow system further increases the complexity. Providing the correct amount of chiller water flow to each chiller becomes an issue. Using dedicated variable flow primary pumps allows chiller specific flow control but creates pump selection and control issues.

If a common pumping plant is used for all chillers then the chiller isolating valves may need to be modulating to control the correct flow rate for each chiller. This may lead to a hunting problem between the valves and the primary pump.

Staging of chillers also becomes complex. Which size chiller should be added or subtracted must now be considered. Variable primary flow chiller plants with different sized chillers have been successfully designed and implemented but it is recommended that the value of different sized chillers be carefully weighed against the additional complexity.

Training and Commissioning

Variable primary flow systems are more difficult to commission than other chiller plant designs and this should not be ignored. All parties involved in the choice, design, commissioning and operating of a variable primary flow system should understand this and be committed to a successful project.

Operator training is especially important. It is critical to a successful installation that a thorough operator training program be part of the project.

Variable Primary Flow Example

Using the model office building from the earlier examples, the graph below compares parallel chiller constant flow with variable primary flow and primary secondary flow.

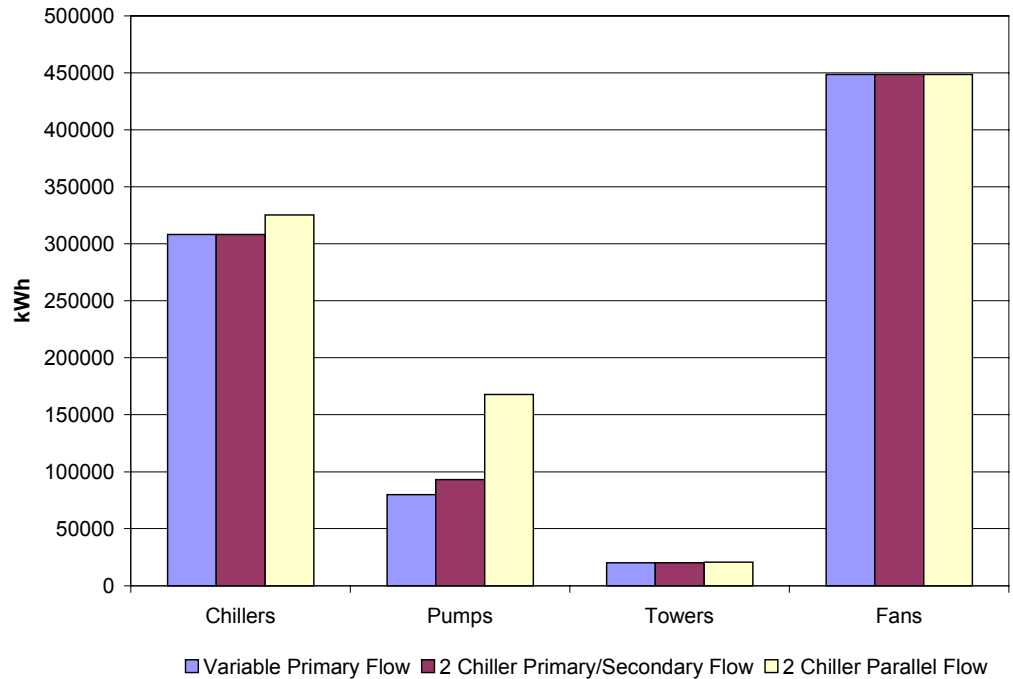

The parallel chiller constant flow arrangement can be used as a benchmark. Both the variable primary flow and primary/secondary flow arrangements have better chiller performance because the chillers can be stage off when not required.

The major savings comes from reduced pump work. The pumps are smaller (flow is based on design load rather than connected load) and the flow varies with the load.

The variable primary flow system outperforms the primary secondary system slightly because the flow is varied through the chiller whereas the primary/secondary system pumps excess flow through the decoupler.

Low Delta T Syndrome

Low delta T syndrome occurs when the design chilled water temperature range is not maintained. Any variable flow system can experience low delta T and the problem is exacerbated at part load. In severe cases, the chilled water range has dropped from 12°F design to 2°F. When this occurs, the flow rate must be increased significantly to provide cooling in the building. The following example illustrates the issue:

Low Delta T Example

Figure 68 shows a basic primary/secondary loop operating at full load. In this example, the system design load is 800 tons, the flow rates and temperatures are at standard ARI conditions and the load has a two-way control valve. The loop with the chiller is called the primary loop. The loop with the load is the secondary loop. The common pipe is sometimes referred to as the decoupler.

Figure 68 - Primary/Secondary Loop at Full Load

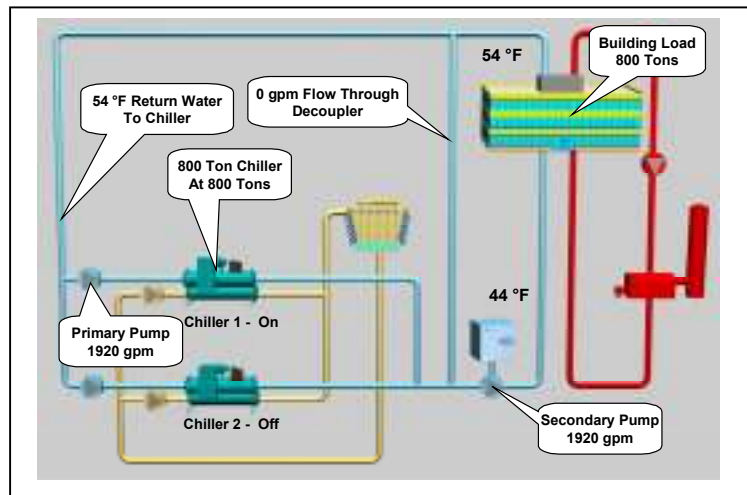

At full load, the design flow of 1920 gpm passes through the chiller, the two pumps, the load, and back to the chiller. There is no flow through the common pipe. At first, it would appear that the flow is being pumped twice. Although this is true, the total head is *split* between the two pumps. The primary pump is only sized for the primary loop of which the chiller is the main pressure drop. The secondary pump is sized for the pressure drop “outside the mechanical

room”. The higher pressure drops and larger piping arrangements in the secondary loop justify the variable flow.

Figure 69 - Primary/Secondary Loop at 50% Load

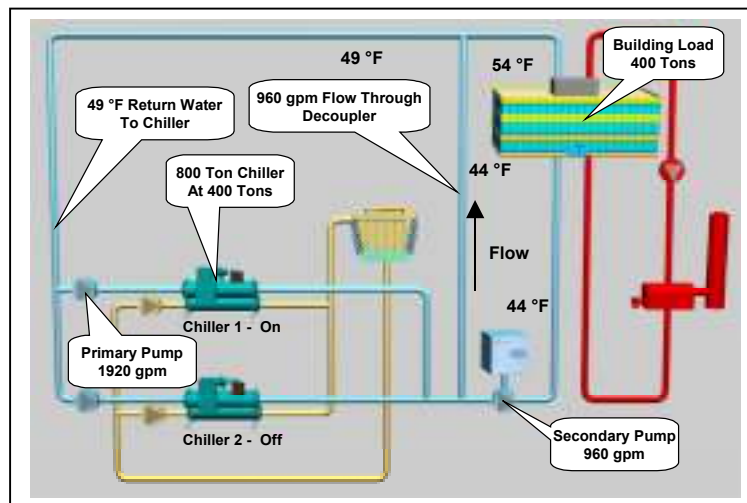

Figure 69 shows the same example operating at 50% capacity. The two-way control valve at the load has reduced the flow in the secondary loop to 960 gpm. The delta T across the load remains at 10°F.

The primary pump is a constant flow pump sized for the chiller design flow. It remains constant at 1920 gpm. The additional flow not required in the secondary loop passes through the common pipe to the chiller

return line. The 44°F fluid from the common pipe mixes with the 54°F return fluid to 49°F. The chiller maintains its design flow of 1920 gpm with 49°F RWT and 44°F LWT. The chiller sees a 50% load.

The example in Figure 69 demonstrates how diversity is applied to flow in the secondary loop. The variable flow in the secondary loop offers excellent pump operating savings and first cost saving in pipe sizing. The constant flow in the primary loop provides the chiller with stable operating conditions.

Figure 70 - Primary/Secondary Loop at Low Delta - T

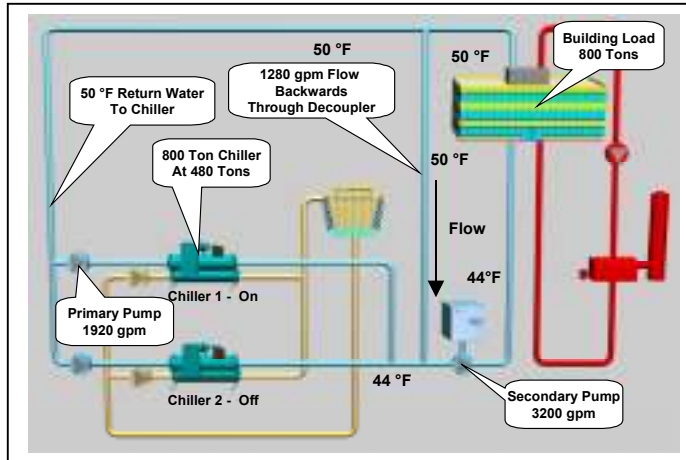

It is important to understand what happens if design temperature range is not maintained. This is known as a low delta T syndrome. Figure 70 shows the previous example with an 800 ton load but only a 6°F delta T. This could be caused by several factors including poor valve selection or dirty coils.

To meet the 800-ton load requirement, the control valve will respond by opening and allowing more flow through the load. The secondary pump will

respond in turn by increasing the secondary loop flow to 3200 gpm to meet the load. The primary pump is only supplying 1920 gpm so 1280 gpm will flow “backward” through the common pipe to meet the 3200 gpm requirement. Two problems now occur. First, the supply fluid temperature in the secondary loop will rise when the primary fluid and the return fluid mix. The higher fluid temperature will cause the control valve to open further, making the problem worse. The second problem is the return water to the chiller is only 50°F so the chiller only sees a 480-ton load. This system will not function well under these conditions.

Figure 71 - Primary/Secondary Loop with Low Delta T Reality

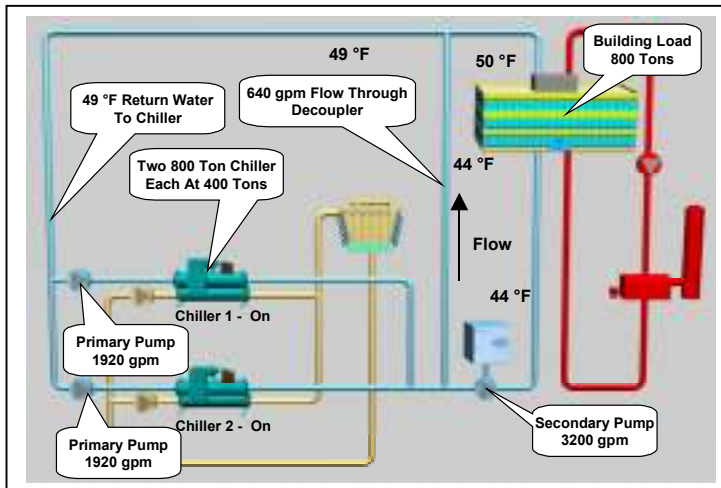

Obviously the above example can't occur. Figure 71 shows what does happen. A second chiller has to be started to balance the flow in the primary loop with the flow in the secondary loop.

Although running two chillers provides a working solution, many of the features of the primary/secondary approach are lost. The flow in the secondary is high, wasting pumping energy. Two primary pumps have to operate when only one should be doubling

the primary pump horsepower. Finally, two chillers are operating (and their condenser water pumps) when only one should be.

Low Delta T Syndrome Causes and Solutions

Many things can lead to low delta T syndrome. The following is a list of common causes and solutions.

Three-Way Valves

Three-way valves bypass unheated chilled water around the cooling coil and into the return line. They will increase the flow rate of the system while not raising the chilled water temperature.

The solution is not to use them. A common reason for including three-way valves in variable flow systems is to avoid a decoupler. While the three-way valves will bypass water when it is necessary to do so just like a decoupler. They will also bypass water when it is not necessary to do so. Using three-way valve instead of a decoupler wastes pump work and causes the low delta T syndrome.

Another common reason is to maintain some flow in the loop so the water remains at setpoint. The goal here is to be able to provide cold chilled water to a cooling coil as soon as it calls for it, rather than having to flush the lines. While this may be important in some situations, it generally is not critical in most HVAC applications. Also consider that chilled water is flowing through the piping at 4 feet per second. Chilled water produced in the basement will travel to the top of a 10-story building in less than 30 seconds.

AHU Setpoints Lowered Below Design

The control loop for the supply air temperature in a typical AHU is a simple arrangement. There is a temperature sensor in the supply air stream. If the temperature is too high, the controller opens the control valve. If the temperature is too low, the valve closes. A common problem is temperature setpoint for the supply air are lowered from the original design to the point where the coil cannot produce the requested supply air temperature. In this case, the control loop will keep open the chilled water valve in an attempt to cool the water further. The result will be a wide open valve bleeding chilled water in to the return line.

The solution is to reset all the AHU supply air setpoints back to design settings. Often these get changed in the first place because a space served by the AHU is not satisfied. Lowering the setpoint will probably not solve the problem and will create a new problem. Once the settings are back to design, the original problem can be identified and remedied.

System Components Not Designed For the Same Temperature Range

For a variable flow system to operate properly, all the components must be designed for the same chilled water temperature range including the chillers and the coils at the loads. If, for instance, the AHUs in a building are designed for 14°F range while the fan coils are sized for 10°F, it is very likely the system will suffer from low delta T syndrome.

The solution can be very complex. Where possible, converting the system to a common temperature range is desirable but often this is cost prohibitive. Another solution is to use tertiary piping. Consider a university campus where buildings were built in different eras with different temperature ranges. Now all the buildings are to be served by a common chiller plant. The chiller plant can be operated with one temperature range and a supply water temperature colder than required by any other load. Tertiary piping at each building can be used to match the supply temperature setpoint and temperature range required.

Coils and Control Valves Not Properly Selected

Improperly selected coils and control valves can lead to excessive chilled water consumption to meet the load requirements.

The solution is to properly select coils and control valves. *Control Valve Basics*, page 20, covers valve selection detail. It is important that the valve actuator have the necessary power to close the valve against the system pressure. Improper coil selection can also lead to difficulties.

Coils Piped “Backwards”

Figure 72 - Proper Coil Connections

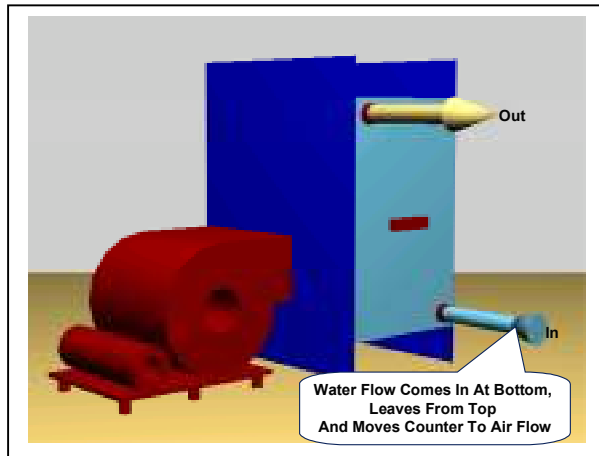

Coils must be connected so the water flow through the rows of the coil is counterflow to the airflow. When coils are improperly connected, the coil performance can drop by as much as 15%. When this occurs, the chilled water control valve will go wide open because the coil is in effect, 15% undersized.

The solution is to properly connect the coils.

Improper Tertiary Piping

Tertiary piping is discussed in, page 55. If there is not a difference in the tertiary loop supply temperature and the main supply line, there is a possibility that the two-way control valve that returns tertiary water to the return line will go wide open in an attempt to get the tertiary loop the same temperature as the supply line. This will end up being a short circuit from the supply line to the return.

The solution is to make sure the tertiary loop is operating at a higher temperature than the main supply line.

Dirty Coils

Dirty coils on either the water or airside will reduce the effectiveness of the cooling coil. The control valve will increase flow in an attempt to offset the coil performance loss and the temperature range will not be maintained.

The solution is to clean the coils.

Airside Economizers and Make-Up Air Units

Coils that cool supply air with a large percentage of outdoor air are sized for a design day. During periods of lighter loads, the supply air temperature to the coil drops. For instance, when the ambient air temperature is 57°F, an AHU with an economizer will switch to 100% outdoor air and thus the inlet air temperature will now be 57°F. Leaving chilled water can never be warmer than the inlet air temperature. When the inlet air temperature is less than the design return water temperature, low delta T syndrome can occur. In the above example, if the design water temperatures are 44°F supply and 58°F return, it will not be possible to obtain 58°F with 57°F entering air.

The solution is to reduce the chilled water range to minimize the occurrences where the return water temperature is higher than the supply air temperature. This has to be weighed against the advantages of reducing pumping cost from using a higher chilled water range.

Chilled Water Reset

Chilled water reset raises the chilled water supply temperature to reduce the lift and thus the compressor work of the chiller. While this a good goal, it now means a higher supply water temperature than used in the design and selection of the coils. When the reduced load allows a coil to meet the load with warmer water, this approach works. On the other hand, when the warmer water

causes the control valves to overflow the coil in an attempt to meet setpoint, then reset can lead to low delta T syndrome.

The solution is careful evaluation and application of chilled water reset. The first step is whether any energy will be saved at all. Raising the chilled water set point will help the chiller. However, it will most likely increase the flow in a variable flow system, which can easily offset any chiller savings. Assuming there are savings available, then chilled water reset is possible. Chilled water reset should not be based on return water temperature but on valve position at the loads.

Other Solutions

The following is list of additional solutions to low delta T syndrome.

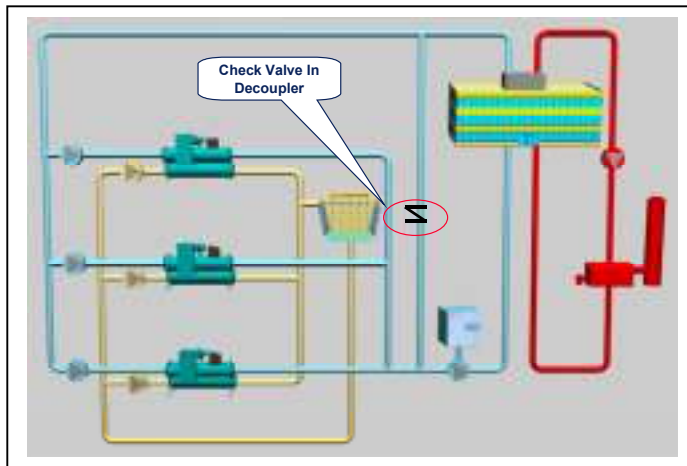

Check Valve In Decoupler

Figure 73 - Check Valve in Decoupler

Adding a check valve in the decoupler changes the nature of the primary/secondary system. When the primary flow exceeds the secondary flow, the system is decoupled and additional primary flow can pass through the decoupler and checkvalve.

When the secondary flow exceeds the primary flow, however, then the pumps are truly in series. The secondary pump will “pull” water through the primary pump as it attempts to maintain system pressure. The chiller flow rate will increase beyond design flow rate. It is extremely unlikely that enough flow will be drawn through the chiller to damage it. In most cases, the chiller can handle a 50% increase in flow which would result in a huge pressure drop. It is unlikely the pumps could provide enough head.

By overpumping a chiller the system can meet the required flow rate and load, and avoid starting a second chiller and the additional pumps and tower.

Increasing the chiller flow rate offers some unique possibilities. If there is condenser relief available, then the chiller may be able to produce more than it’s design capacity (For example a 100-ton chiller may produce 110 tons with condenser relief). To take advantage of the extra capacity, the system would have to increase the temperature range across the chiller (difficult to do since the system is typically experiencing just the opposite!) or the flow rate would have to be increased. By overpumping a chiller, it may be possible to produce more than the design capacity and avoid additional pumps and tower work.

Adding a check valve effectively makes the system variable primary flow during low delta T intervals. System control becomes more complicated as well. How and at what point is a second chiller added? It is recommended that check valves not be added to primary/secondary systems as part of the design. If variable primary flow is the intention, then the system should be designed with that goal in mind. When a system is exhibiting signs of low delta T syndrome, the previous remedies should be investigated first prior to adding a check valve.

VFD Or Dual Compressor Chillers

The main problem with low delta T syndrome is the increase in energy usage due to multiple chillers, pumps and towers operating to meet a light load. VFD and dual compressor chillers offer a different solution. The high part load efficiency of these kinds of chillers promotes operating two chillers rather than one to meet the load. Two VFD or dual compressor chillers operating partly loaded can

consume less energy than one chiller operating fully loaded. If the energy savings offset the penalty of the pumps and tower, then VFD and dual compressor chillers are good solutions to low delta T syndrome.

Oversize Primary Pumps

Oversizing the primary pumps allows the additional flow to be pumped through the chillers and maintain the primary flow above the secondary flow. Overpumping a chiller can also allow any additional capacity (See *Check Valve In Decoupler*, page 84) in the chiller to be utilized.

Reduce Temperature Range on Primary Side

Reducing the chilled water temperature range on the primary side increases the flow rate for the same capacity. During periods of light load, when low delta T syndrome occurs, the lower delta T/higher flow rate on the primary side will counter act problems on the secondary side.

One draw back is the additional pump work on the primary side wastes energy at all operating points. The possible savings offered by avoiding low delta T syndrome at light loads may be offset by the penalty created at other operating points.

Add Flow Control Valves at Each Coil

Adding flow control valves at each load rated for the maximum flow rate will ensure the load won't consume too much chilled water. From the chiller plant perspective, this will avoid low delta T, However, space serviced by the coil may not be satisfied. In addition, most control valves create a pressure drop that the chilled water pumps must be sized to overcome. Overcoming the additional pressure drop will add to the annual cost of operating the pumps.

Variable Primary Flow

Low delta T syndrome occurs because of issues at the loads (coils). These will happen with variable primary flow or primary secondary systems. Variable primary flow (VPF) does allow several solutions to be easily implemented:

- ❑ Do not have a decoupler that allows return chilled water to flow into the supply side. Return chilled water will raise the supply water temperature and exacerbate the problem.
- ❑ VPF allows chillers to be overpumped. See *Check Valve In Decoupler*, page 84.
- ❑ VPF systems typically have flow meters, which can help the operator recognize a low delta T situation and be used by the BAS to remedy the problem.

Process Applications

Process applications can place unique demands on chiller plants. All parties involved in a process application should be fully aware that it is a process and not an HVAC application to avoid any confusion.

Process Load Profiles

Process loads can be broken down in to specialized environments and chilled water for the actual processes. Specialized environments such as low relative humidity (RH) for pharmaceutical or confectionery manufacturers are an extension of conventional HVAC design.

Chilled water for processes and equipment can be quite a bit different than HVAC design. Remember that process loads generally have very little to do with ambient conditions. It is quite possible that the process will be operating at 5% on the hottest day of the year and 100% on the coldest day. It is extremely important to gather as much information about the process, the load profile the operating conditions, etc., as possible. Adding a process load to an HVAC chiller plant without consideration can lead to very poor performance.

The designer should gather at least the following information:

- The process design load. Is it constant? Is it stepped or a batch load?
- Are there multiple process loads with different needs? Do they have to be handled individually or can a common system serve both?
- The operating hours. Is it every hour of the year? Is it only in the summer? This will lead to a discussion about redundancy. In HVAC design, redundancy often means there are at least two pieces of equipment but not necessarily enough capacity to meet the design load if one of them should fail. In process applications, redundancy usually means 100% backup so no production time is lost.
- The critical nature of the process. Can the customer live without chilled water? If so, how long? All chiller plant equipment must be serviced at some point offline. How will this be accommodated?
- Will the chiller plant service HVAC loads as well? If so, the combination of the two load profiles will need to be considered.

Constant Load Profiles

Constant load profiles have very little change for long periods of time. The goal here is to optimize the chiller plant for full load performance.

Stepped Load Profiles

Stepped profiles are most common. An example of a stepped process is cooling molds for injection molding. If there are only two molds, then shutting down one line is an instant 50% reduction in chiller plant load. The quick changes in load must be accounted for. The chiller plant should be optimized to performance well at the various “plateaus” in a stepped load profile.

Batch Load Profiles

Batched operations, such as a bakery, require a relatively sudden amount of chilled water and then nothing for an extended period of time. This profile lends itself to some form of chilled water storage and charging in anticipation of the load. The load size and the intervals are critical to proper operation.

Condenser Relief

As mentioned earlier, there is typically no correlation between process load and the ambient conditions. Most chiller ratings and design are based on HVAC load profiles which are tied to the ambient conditions. This is very true for condenser relief where ARI 550/590-98 allows a condenser relief profile based on HVAC design. For example consider a centrifugal chiller used in a process application. The process load drops to 25% on the hottest day of the year. It would not be expected in an HVAC load to ever operate at 25% on a design day. The chiller may not even be able to meet the lift requirement at these conditions. Chillers used for process must be rated at process conditions.

☺ *Tip: As the cooling tower load goes from 100% to 0%, the supply water temperature approaches wetbulb. This can be used to estimate the entering condenser water temperature for part load rating of a process chiller.*

Figure 74 - ARI 550/590 vs. Process Condenser Relief

As the load on a cooling tower goes from 100% to 0% the leaving condenser water approach will go from design (For example there is a 7°F approach with 85°F supply water temperature and 78°F ambient wetbulb) to 0°F. This can be used to estimate the correct condenser relief for a process chiller on a design day.

For instance, in the example given above, the entering condenser water at 25% load and ARI 550/590 conditions would be 65°F. Using the above relationship for cooling towers, the actual entering condenser water temperature would be 79.75°F.

Process chillers should be selected where possible to operate down to minimum capacity with the condenser water temperature being the same as the design wetbulb. If stable operation for the chiller is exceeded, then hot gas bypass should be added.

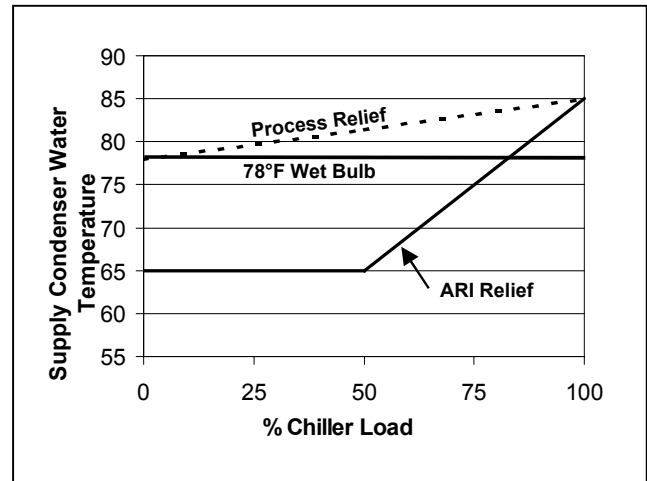

Winter Design

Most process chillers operate year-round. In colder climates, winter design must be considered. The equipment manufacturer should be involved in assessing the safe, reliable operation of chiller in subfreezing conditions.

The very high operating hours provide an excellent opportunity for using the cooling towers and a heat exchanger to directly cool the process load in a manner similar to waterside free cooling (Refer to *Water-Side Free Cooling*, page 61).

Chilled Water Volume

Process loads with sudden changes in load are a challenge for a chiller. The best method to deal with them is to have a large enough flywheel effect in the chilled water system to limit the rate of change seen by the chiller. There may be enough chilled water volume in the system to provide the necessary flywheel effect. If not, then a tank may be required. Different chillers have different limits for rate of change and thus require different system volumes. Refer to *Minimum Chilled Water Volume*, page 89 and the chiller product catalog for details.

Temperatures and Ranges

Chilled water supply temperature and chilled water ranges must be reviewed and based on the needs of the processes served. It should be first surmised what chilled water temperatures and ranges are required and whether a single supply water temperature will work. The use of a tertiary pump can allow for different temperatures but the chiller plant will have to provide all the chilled water at the lowest required temperature. This will lower the chiller efficiency for the entire plant. It may be advantageous to have medium and low temperature chilled water systems.

In many process applications such as injection molding, avoiding condensation is important; in which case the chilled water temperature should be above the space dewpoint. The warmer the chilled water, the more efficient the chillers. There are processes that require chilled water warmer than the chiller is rated to provide. This can be resolved with mixing valves.

Temperature ranges can also vary a lot. For instance, a process may require 60°F supply water and a 30°F temperature range. These conditions are beyond the range of most chillers so the system design must accommodate them.

Figure 75 - Process Piping Arrangement

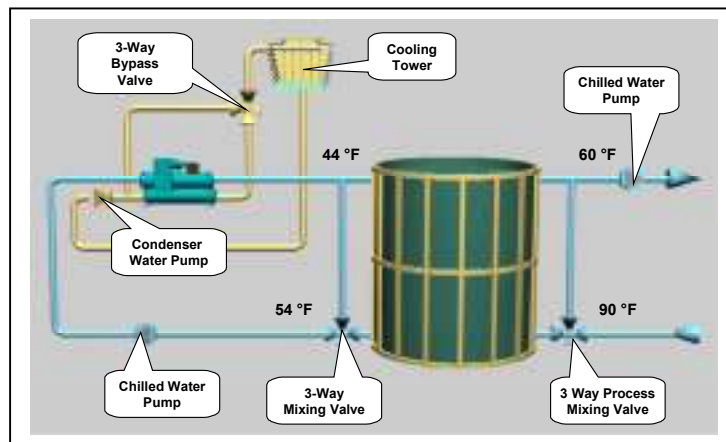

Figure 75 shows a typical piping arrangement to deal with high supply water temperature, large temperature range and small chilled water volume.

This arrangement allows the chiller to operate at optimized conditions while meeting the requirements of the process. The storage tank provides the necessary buffer to limit the rate of change.

Minimum Chilled Water Volume

The volume of chilled water in the chilled water system acts as a damper and smoothes out the effects due to load change. Process loads tend to be the most abrupt and can cause the chiller to shutdown on a safety if the system is not designed correctly. As well, when a chiller is close coupled to a large dominant air conditioning load (A chiller connected to a single large air handling unit for example) the chiller can “hunt” on control valve and result in unstable operation.

There are other issues, which need to be considered as well. For instance, a small chiller using scroll compressors will change capacity in discrete steps (For example, a four compressor chiller will have a stepped capacity of 25, 50, 75 and 100% cooling capacity). If the load is between the steps (For example 65% capacity), then the chiller will operate at the step above and then the step below the actual load. The chiller will require the chilled water fluid volume to “dampen” the effect of the chiller either over or under cooling the chilled water.

© *Tip: The volume of a coil can be estimated by using 0.15 US Gal/sq ft-row. For instance, a 48” x 60”, 5 row coil has 20 ft² x 5 rows x 0.15 = 15 US Gal.*

Another example is where the load drops below the minimum capacity the chiller can operate. In this case, the chiller will cycle a compressor on and off to meet the load. If there is not enough fluid in the system, the compressor will incur too many starts, which will result in undue wear.

Estimating System Volume

To evaluate whether there is sufficient volume in the system requires first estimating the amount of fluid in the system. To find the volume, the amount of fluid in the chiller evaporator, piping and coils must be added together. Table 8 provides the fluid volume per foot for standard piping. Chiller evaporator volumes can be found in the chiller catalogs and/or computer printouts. Coil volumes are often provided by computer selection outputs or can be estimated by assuming 0.15 US gal per sq. Ft.- Row.

Table 8 – Fluid Volume for Standard Pipe

Nominal Pipe Dia. (in.)	US Gal. Per Linear Ft.	Nominal Pipe Dia. (in.)	US Gal. Per Linear Ft.
1	0.037	6	1.35
1½	0.092	8	2.37
2	0.153	10	3.88
2½	0.221	12	5.63
3	0.343	14	6.63
3½	0.462	16	8.57
4	0.597	18	11.1
5	0.945	20	13.9

Evaluating System Volume

Whether there is sufficient fluid volume can be found using the following formula:

$$V_w = \frac{T_s}{500* \left\{ \frac{TD}{(H_1 - H_2)} \right\} + \left\{ \frac{TD}{H_2} \right\}}$$

Where:

T_s = Time from start to start (Minutes)

V_w = Fluid volume (US gal)

H_1 = Minimum operating capacity of the chiller (Btu/Hr)

H_2 = Minimum applied load on the chiller (Btu/Hr)

TD = Dead band of chiller controller (°F)

The values used in this formula should come from the specific chiller and application. Where these values are not immediately known, Table 9 provides some guidance. Chiller short cycling is a serious issue that can shorten the life or damage equipment and result in poor performance. Whenever a chiller is closed coupled to a single large load, the designer should review this issue carefully.

Table 9 – Typical Parameters for Various Chiller Types

Chiller Type	T_s = Time between starts (Minutes)	H_1 = Minimum operating capacity of the chiller (Btu/Hr)	TD = Dead band of chiller controller (°F)
Scroll Compressor	15	25	4
Reciprocating Compressor	15	25	4
A/C Screw	30	25	4
W/C Screw	30	25	4
Centrifugal	30	10	4
Dual Compressor Centrifugal	30	5	4

Minimum Fluid Volume Example

Consider a 200-ton system using an air cooled screw chiller with two 100 ton compressors. The fluid flow rate is 480 US gpm and the minimum load (H_2) is 10-tons.

Is a chilled water storage tank necessary and if so, how large?

The first step is to estimate the volume of fluid in the system.

Chiller Evaporator = 40 US Gal

Piping = 50 ft of 5 in. Sched. 40 pipe. From Table 8, the volume is 45 US Gal.

The Coil is 48" x 60" by 5 row. Using the rule of thumb, the volume is 15 US Gal.

The total system volume (V_w) is 100 US. Gal.

The next step is to estimate the minimum required volume.

The chiller unit controller has a 4°F deadband (TD) from the time it cycles off to the time it will start again. To protect the compressors, a 30 minute start to start (T_s) period is desirable. The minimum capacity (H_1) of the chiller is 25 tons.

$$V_w = \frac{30}{500^*} \left\{ \frac{4}{(300,000 - 120,000)} \right\} + \left\{ \frac{4}{120,000} \right\}$$

= 1080 US Gal

Since the system only has 100 US Gal volume, a 980 US Gal storage tank is required.

A common rule of thumb is to use a minimum time for all the fluid in the system to circulate once. In this example, the time is 2.25 minutes. This is not reliable however since a large temperature range would have a smaller flow rate and yield a different minimum volume requirement. Yet the volume is really controlled by how fast the minimum load raises the temperature and how fast the minimum chiller capacity lowers the temperature.

It is worth considering what would happen if a storage tank is not included. The minimum chiller capacity is 2.5 times larger than the actual load. Even at minimum capacity, the chiller will "over cool" the chilled water. The supply chilled water temperature will drop below setpoint until it reaches the minimum allowable temperature, then the chiller will shut off. While the chiller is off, the 10-ton load will raise the chilled water temperature until the temperature reaches the high limit of the chilled water deadband. If the compressor start to start time has not been reached, the chiller will not start and the chilled water temperature will continue to rise. Poor system performance may occur. Shortening the start to start time will resolve the performance, however it may put undue stress on the chiller. The reverse is also true, extending the start to start time will protect the chiller but will lower performance.

Conclusions

Chillers and chiller plant design provide the designer a very flexible solution to meet the needs of the project. This Guide only covers the basics. The references indicate additional material the designer may wish to review. Key things for the designer to remember are the full load performance of a chiller plant is not a good indicator of its overall performance. Many systems may have the same full load energy requirement but are quite different at part load. Since chiller plants rarely operate at full load, part load performance is critical to good annual performance. For more information please contact your McQuay Sales Representative or McQuay International at www.mcquay.com.

References

- 1998 ASHRAE Refrigeration Handbook** ASHRAE. Atlanta, Ga
- 1999 ASHRAE HVAC Applications Handbook** ASHRAE. Atlanta, Ga
- 2000 ASHRAE HVAC Systems and Equipment Handbook** ASHRAE. Atlanta, Ga
- 2001 ASHRAE Fundamentals Handbook** ASHRAE. Atlanta, Ga
- 3 GPM/Ton Condenser Water Flow Rate: Does It Waste Energy?** - Kirsner, Wayne ASHRAE Journal, February 1996. ASHRAE. Atlanta Ga.
- All Variable Speed Centrifugal Chiller Plants** - Hartman, Thomas. ASHRAE Journal, September 2001. ASHRAE. Atlanta Ga.
- ANSI/ASHRAE Standard 15-2001, Safety Standard for Refrigeration Systems..** ASHRAE. Atlanta, Ga.
- ANSI/ASHRAE Standard 34-2001, Designation and Safety Classification of Refrigerants.** ASHRAE. Atlanta, Ga.
- ANSI/ASHRAE Standard 90.1-2001, Energy Standard for Buildings Except Low-Rise Residential Buildings.** ASHRAE. Atlanta, Ga.
- ARI Standard 550/590 – Water Chilling Packages Using The Vapor Compression Cycle–** Air-Conditioning and Refrigeration Institute. 1998. Arlington, Va.
- ARI Standard 560 – Absorption Water Chilling and Water Heating Packages –** Air-Conditioning and Refrigeration Institute. 2000. Arlington, Va.
- ASHRAE 90.1 Users Manual.**2000. ASHRAE. Atlanta, Ga.
- Chilled Water System Forensics –** Luther, Kenneth. 2002. ASHRAE Transactions AC-02-6-2. ASHRAE, Ga.
- Control Valve Selection –** Haines, Roger. September 1980. Heating, Piping and Air Conditioning.
- Controlling Chillers in Variable Flow Systems** - Avery, Gil ASHRAE Journal, February 1998. ASHRAE. Atlanta Ga.
- Cooling Tower Optimization** - Shelton, Sam, Charles Joyce. ASHRAE Journal, June 1991. ASHRAE. Atlanta Ga.
- Cooling Towers Used For Free Cooling** - Murphy, Dan. ASHRAE Journal, June 1991. ASHRAE. Atlanta Ga.
- CSA B52-99, Mechanical Refrigeration Code.** CSA International. Rexdale Ont. Canada.
- Degrading Chilled Water Plant Delta-T: Causes and Mitigation** - Taylor, Steven. ASHRAE Transactions AC-02-6-1. ASHRAE, Ga.
- Engineering Data Book - Valves –** LIT-237VB. 1994 Johnson Controls. Milwaukee, Wn.
- How to Raise Chilled Water Differentials** - Fiorino, Donald. ASHRAE Transactions AC-02-6-3. ASHRAE, Ga.
- Improving the Efficiency of Chilled Water Plants** - Avery, Gil ASHRAE Journal, May 2001. ASHRAE. Atlanta Ga.
- Near-Optimal Control of Cooling Towers for Chilled Water Systems –** Braun, J.E., G. T. Diderrich. 1990. ASHRAE Transactions SL –90-13-3. ASHRAE, Ga.
- Piping Chillers to Variable Volume Chilled Water Systems** - Rishel, James. ASHRAE Journal, July, 1994. ASHRAE. Atlanta Ga.
- Pressure and Flow Control in Hot and Chilled Water Piping –** Hallanger, Erling Oct. 1982. Heating, Piping and Air Conditioning..
- Pumping Energy and Variable Frequency Drives** - Bernier, Michel. Bernard Bourret. ASHRAE Journal, December 1999. ASHRAE. Atlanta Ga.
- Selecting Valves and Piping Coils** - Avery, Gil ASHRAE Journal, April 2000. ASHRAE. Atlanta Ga.
- Technology of Balancing** -. Armstrong. Armstrong. Scarborough, On. Canada.

Varying Chilled Water Flow with Success - Lunnenberg, Tom E Source Report ER-01-11, July 2001. E Source, Boulder Co.

McQuay Engineering Solutions, Will Variable Evaporator Flow Negatively Affect Your Centrifugal Chiller? – Edition 3, April 2003. McQuay International, Minneapolis, Mn.

McQuay Engineering Solutions, Air Cooled Chillers-Benefits and Design Tips – Edition 7, April 2001. McQuay International, Minneapolis, Mn.

McQuay Engineering Solutions, Series Chillers, What's Old Is New Again. January 2002. McQuay International, Minneapolis, Mn.

