



Air Conditioning Clinic

Centrifugal Water Chillers

One of the Equipment Series



TRG-TRC010-EN

NO POSTAGE
NECESSARY
IF MAILED
IN THE
UNITED STATES

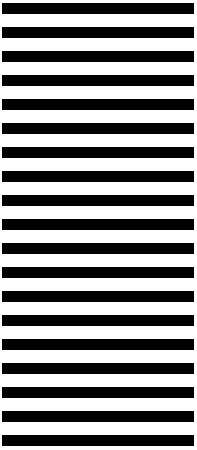

BUSINESS REPLY MAIL
FIRST-CLASS MAIL PERMIT NO. 11 LA CROSSE, WI

POSTAGE WILL BE PAID BY ADDRESSEE

THE TRANE COMPANY
Attn: Applications Engineering
3600 Pammel Creek Road
La Crosse WI 54601-9985



NO POSTAGE
NECESSARY
IF MAILED
IN THE
UNITED STATES

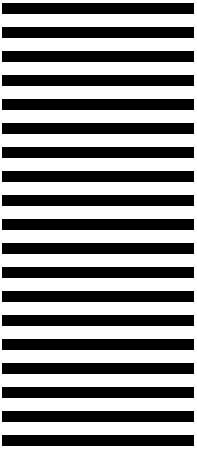

BUSINESS REPLY MAIL
FIRST-CLASS MAIL PERMIT NO. 11 LA CROSSE, WI

POSTAGE WILL BE PAID BY ADDRESSEE

THE TRANE COMPANY
Attn: Applications Engineering
3600 Pammel Creek Road
La Crosse WI 54601-9985



Crop to width of 7.75"

Perforation 0.75" from edge

Comment Card

We want to ensure that our educational materials meet your ever-changing resource development needs. Please take a moment to comment on the effectiveness of this Air Conditioning Clinic.

Centrifugal Water Chillers One of the Equipment Series

TRG-TRC010-EN

Level of detail (circle one) Too basic Just right Too difficult

Rate this clinic from 1-Needs Improvement to 10-Excellent ...

	1	2	3	4	5	6	7	8	9	10
Content										
Booklet usefulness										
Slides/illustrations										
Presenter's ability										
Training environment										

Other comments? _____

About me ...

Type of business _____
 Job function _____
 Optional: name _____
 phone _____
 address _____

Give the completed card to the presenter or drop it in the mail. Thank you!



TRANE

*The Trane Company • Worldwide Applied Systems Group
 3600 Pammel Creek Road • La Crosse, WI 54601-7599
 www.trane.com
 An American-Standard Company*

Perforation 5.5" from bottom/top

Response Card

We offer a variety of HVAC-related educational materials and technical references, as well as software tools that simplify system design/analysis and equipment selection. To receive information about any of these items, just complete this postage-paid card and drop it in the mail.

- Education materials** Air Conditioning Clinic series
 Engineered Systems Clinic series
 Trane Air Conditioning Manual
 Trane Systems Manual
- Software tools** Equipment selection
 System design & analysis
- Periodicals** Engineers Newsletter
- Other?** _____

About me ...

Name _____
 Title _____
 Business type _____
 Phone/fax _____
 E-mail address _____
 Company _____
 Address _____

Thank you for your interest!



TRANE

*The Trane Company • Worldwide Applied Systems Group
 3600 Pammel Creek Road • La Crosse, WI 54601-7599
 www.trane.com
 An American-Standard Company*



Centrifugal Water Chillers

One of the Equipment Series

**A publication of
The Trane Company—
Worldwide Applied Systems Group**

Preface

Centrifugal Water Chillers

A Trane Air Conditioning Clinic

Figure 1

The Trane Company believes that it is incumbent on manufacturers to serve the industry by regularly disseminating information gathered through laboratory research, testing programs, and field experience.

The Trane Air Conditioning Clinic series is one means of knowledge sharing. It's intended to acquaint a nontechnical audience with various fundamental aspects of heating, ventilating, and air conditioning.

We've taken special care to make the clinic as uncommercial and straightforward as possible. Illustrations of Trane products only appear in cases where they help convey the message contained in the accompanying text.

This particular clinic introduces the concept of **centrifugal water chillers**.

Contents

	Introduction	1
period one	Components	3
	Compressor	4
	Condenser	7
	Expansion Device	8
	Economizer	9
	Evaporator	11
	Motor	12
	Controls and Starter	13
period two	Refrigeration Cycle	15
	Refrigerants	19
	Purge System	20
period three	Compressor Capacity Control	22
period four	Maintenance Considerations	30
period five	Application Considerations	36
	Condensing Temperature Control	37
	Constant or Variable Evaporator Water Flow	39
	Short Evaporator-Water Loops	40
	Heat Recovery	42
	Free Cooling	44
	Equipment Certification Standards	46
period six	Review	48
	Quiz	52
	Answers	54
	Glossary	55



Introduction

notes

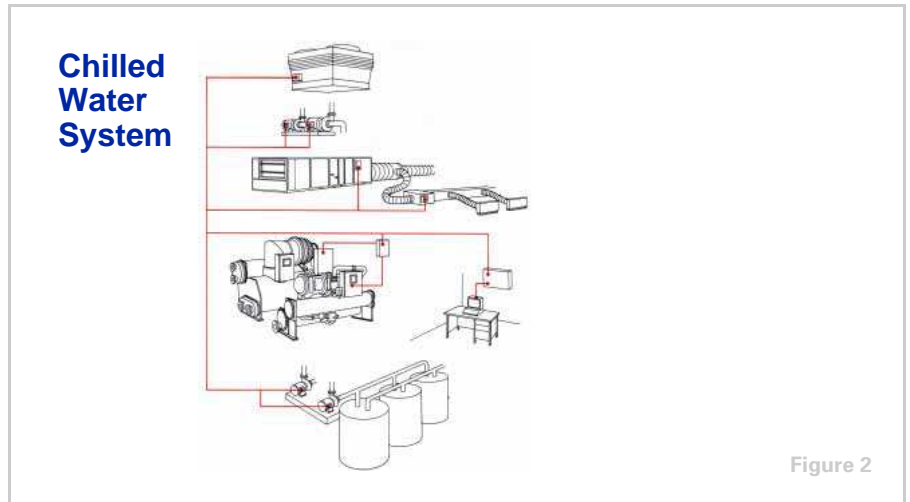

Water chillers are used in a variety of air conditioning and process cooling applications. They are used to make cold water that can be transported throughout a facility using pumps and pipes. This cold water can be passed through the tubes of coils to cool the air in an air conditioning application, or it can provide cooling for a manufacturing or industrial process.

Systems that employ water chillers are commonly called **chilled water systems**.

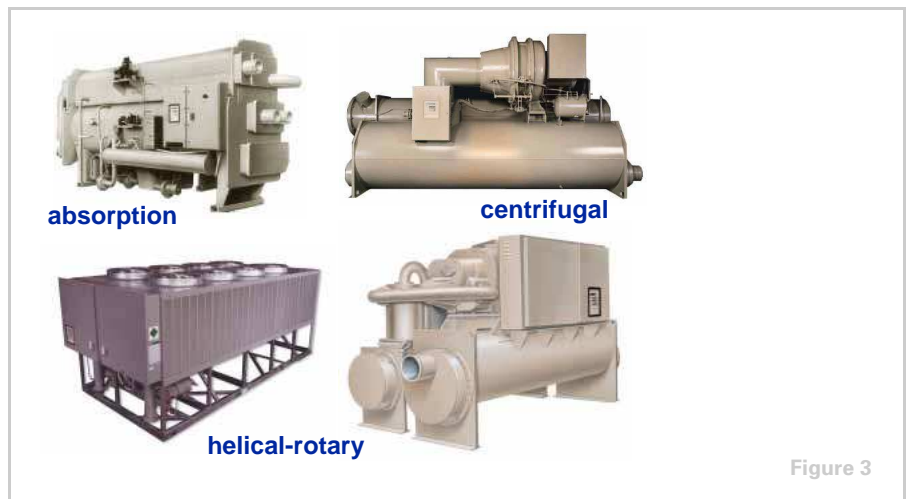

There are several types of water chillers. They differ from each other based on the refrigeration cycle or the type of compressor they use.

Absorption water chillers make use of the absorption refrigeration cycle and do not have a mechanical compressor involved in the refrigeration cycle.

Introduction

notes

Water chillers using the vapor-compression refrigeration cycle vary by the type of compressor used. Reciprocating and scroll compressors are typically used in small chillers. Helical-rotary (or screw) compressors are typically used in medium-sized chillers. Centrifugal compressors are typically used in large chillers.

As mentioned earlier, this particular clinic discusses **centrifugal water chillers**.



Centrifugal water chillers can also be divided into two types based on the method used to reject heat to the atmosphere: water-cooled or air-cooled. Since most centrifugal chillers are water-cooled, they are the primary focus of this clinic. Water-cooled centrifugal chillers are generally available from 100 to 3,000 tons [350 to 10,500 kW] as prefabricated machines, and up to 8,500 tons [30,000 kW] as built-up machines.

period one

Components

notes

Centrifugal Water Chillers

period one
Components

Figure 5

Many of the components of the centrifugal water chiller are similar to those of other chiller types.

components of a Centrifugal Water Chiller

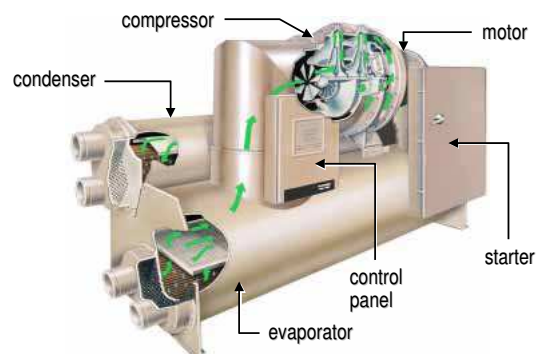

Figure 6

This particular centrifugal water chiller makes use of a shell-and-tube evaporator where refrigerant absorbs heat from the water flowing through the tubes. The compressor is made up of 1 or more centrifugal impellers. A second shell-and-tube heat exchanger serves as the water-cooled condenser, where refrigerant is condensed inside the shell and water flows inside tubes. Refrigerant is metered through the system using an expansion device such as a fixed orifice plate. An economizer can be used to enhance the efficiency of a chiller with multiple compressor impellers. A control panel is also provided on the chiller and a starter is either mounted on the chiller or located remotely.

period one
Components

notes

Compressor



Figure 7

Compressor

The centrifugal compressor uses the principle of **dynamic compression**, which involves converting energy from one form to another, to increase the pressure and temperature of the refrigerant. It converts kinetic energy to static energy.

Impeller

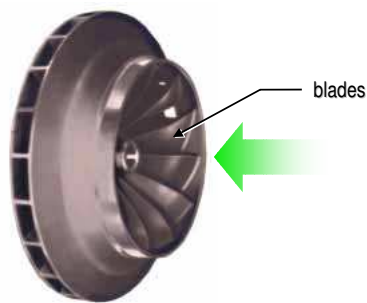
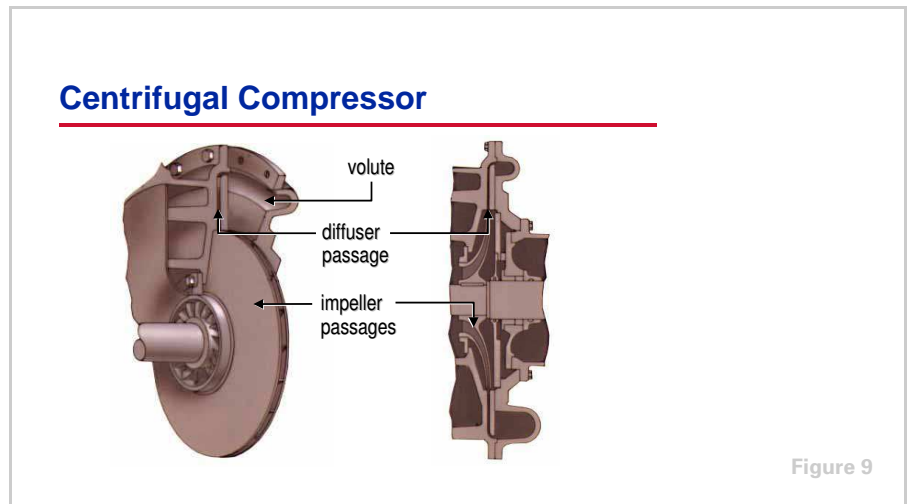

Figure 8

The core component of a centrifugal compressor is the rotating **impeller**. The center, or eye, of the impeller is fitted with blades that draw refrigerant vapor into radial passages that are internal to the impeller body.

period one
Components

notes



The rotation of the impeller causes the refrigerant vapor to accelerate within the **impeller passages**, increasing its velocity and kinetic energy.

The accelerated refrigerant vapor leaves the impeller and enters the **diffuser passages**. These passages start out small and become larger as the refrigerant travels through them. As the size of the diffuser passages increases, the velocity, and therefore the kinetic energy, of the refrigerant decreases.

The first law of thermodynamics states that energy is not destroyed—only converted from one form to another. Thus, the refrigerant's kinetic energy is converted to static energy or static pressure.

Refrigerant, now at a higher pressure, collects in a larger space around the perimeter of the compressor called the **volute**. The volute also becomes larger as the refrigerant travels through it. Again, as the size of the volute increases, the kinetic energy is converted to static pressure.

Due to its pressure and temperature, the refrigerant leaving the compressor is in a condition that allows its heat to be rejected from the chiller.

period one

Components

notes

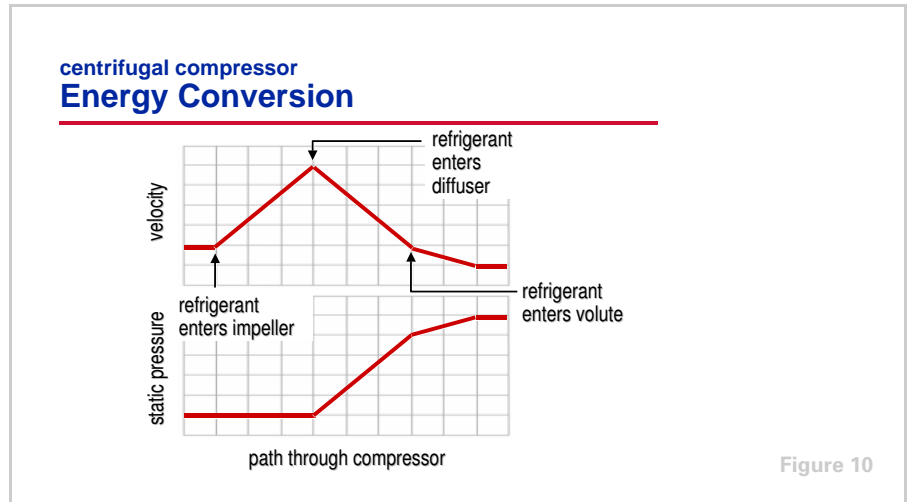

Again, in the passages of the rotating impeller, the refrigerant vapor accelerates, increasing its velocity and kinetic energy. As the area increases in the diffuser passages, the velocity, and therefore the kinetic energy, of the refrigerant decreases. This reduction in kinetic energy is offset by an increase in the refrigerant's static energy or static pressure. Finally, the high pressure refrigerant collects in the volute around the perimeter of the compressor, where further energy conversion takes place.

The resulting pressure and temperature of the refrigerant is now high enough that its heat can be rejected from the chiller.

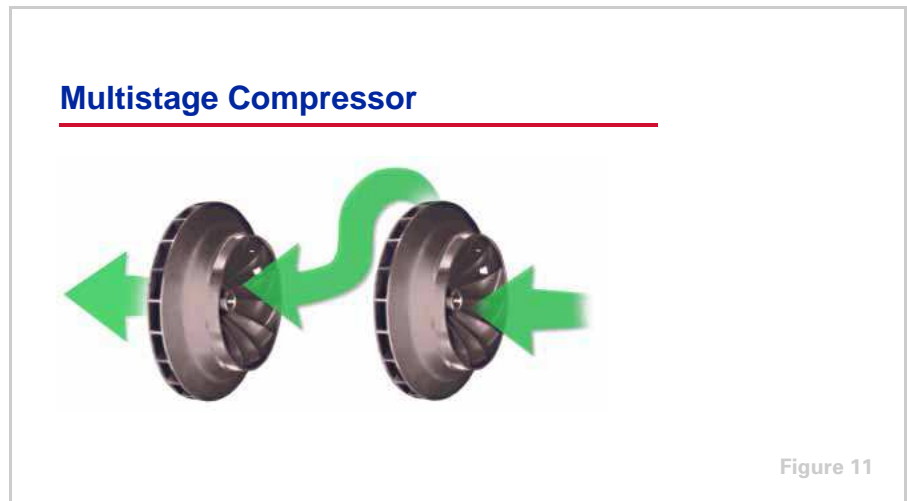

Centrifugal compressors use 1 or more impellers to compress the refrigerant. A **multistage compressor** uses 2 or 3 impellers to increase the pressure of the refrigerant in steps instead of performing the task within a single impeller. Compressed refrigerant vapor travels from the outlet of the first-stage compressor impeller to the inlet of the second-stage compressor impeller. After

period one

Components

notes

the accelerated refrigerant vapor leaves the last impeller, it collects in the compressor volute and travels on to the condenser.

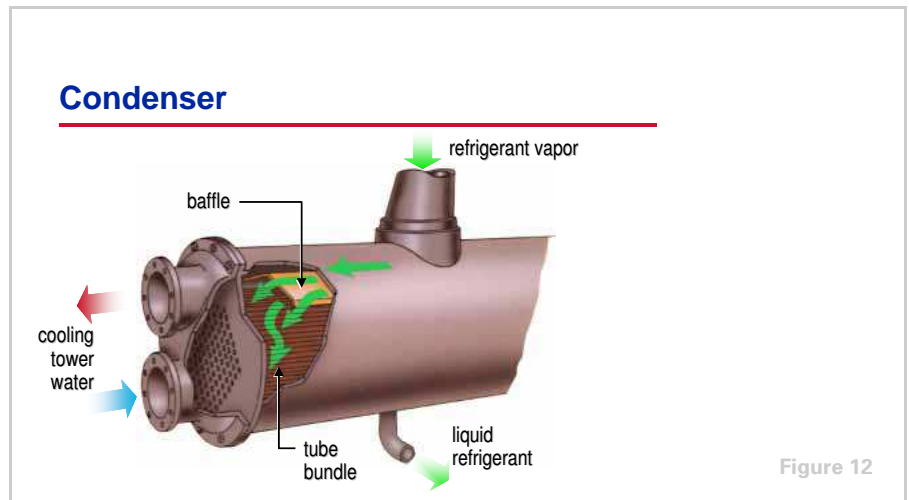

Condenser

The high-pressure refrigerant vapor is discharged from the compressor into a heat exchanger that acts as a condenser.

In a water-cooled **condenser**, water is pumped through the tubes of the shell-and-tube heat exchanger while refrigerant vapor fills the shell space surrounding the tube bundle. A baffle inside the condenser helps distribute the refrigerant evenly. As heat transfers from the hot, high-pressure refrigerant vapor to the water, refrigerant condenses on the tube surfaces.

Cooling water flows first through the lower tubes and then through the upper tubes. This produces a nearly constant temperature difference between the downward-moving refrigerant and the tube surfaces, resulting in a uniform heat transfer rate within the tube bundle.

Condensed liquid refrigerant collects in the bottom of the shell and flows through the liquid line to the expansion devices and economizer.

period one
Components

notes

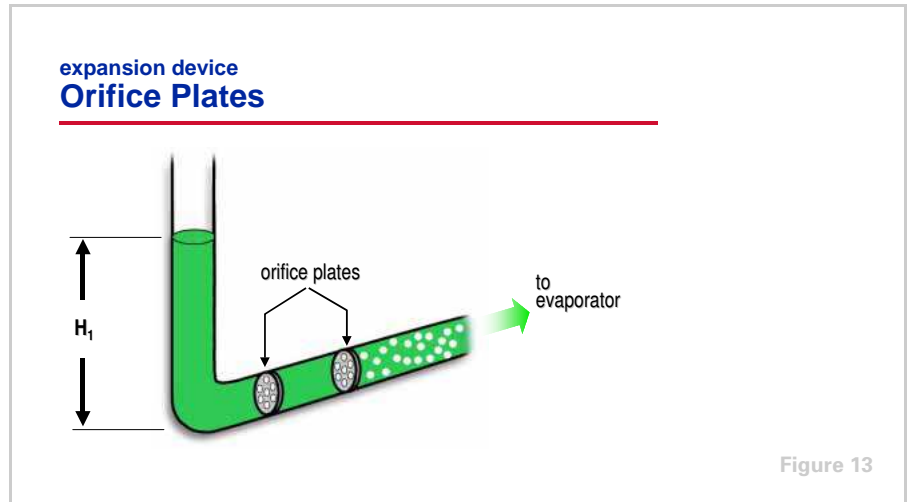

Expansion Device

An **expansion device** is used to maintain the pressure difference between the high-pressure (condenser) and low-pressure (evaporator) sides of the refrigeration system, as established by the compressor. This pressure difference allows the evaporator temperature to be low enough for the refrigerant to absorb heat from the water being cooled, and the condenser temperature to be high enough for the refrigerant to reject heat to water at normally available temperatures. High-pressure liquid refrigerant flows through the expansion device, causing a pressure drop that reduces the refrigerant pressure to that of the evaporator. This pressure reduction causes a small portion of the liquid to boil off, or “flash,” cooling the remaining refrigerant to the evaporator temperature.

The expansion device is also used as a liquid refrigerant metering system, balancing the refrigerant flow rate with the evaporator load condition. In our example centrifugal chiller, the expansion device used is a set of **2 orifice plates**. At full load, a large amount of refrigerant is moving through the chiller. The column of liquid refrigerant in the liquid line pressurizes the liquid at its base. During passage through the orifice plates, the liquid refrigerant undergoes a pressure drop equal to the head (**H₁**) before some of it flashes to vapor.

period one

Components

notes

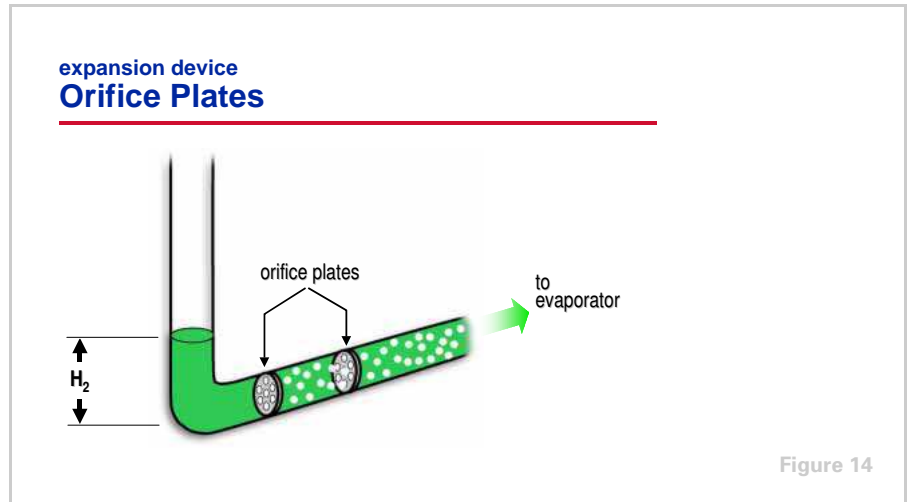

As the load decreases, less refrigerant moves through the chiller and the level of the liquid column drops. Now, as the liquid refrigerant passes through the orifice plates, it only undergoes a pressure drop equal to the lower head (**H₂**) before some of it flashes to vapor. This causes additional flashing at the orifice plate which, in turn, feeds less liquid to the evaporator.

Other types of expansion devices found in centrifugal chillers include: float valves, expansion valves (thermostatic or electronic), and variable orifices.

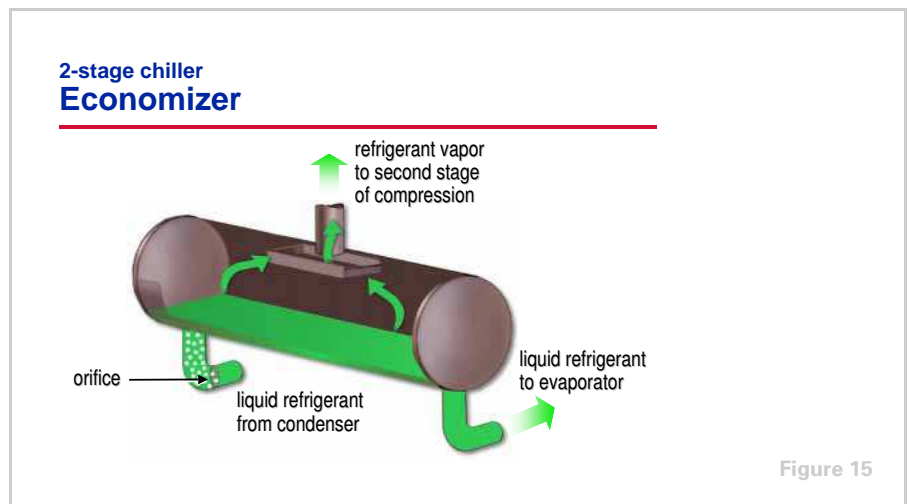

Economizer

An **economizer** can be used in conjunction with multiple expansion devices to improve the efficiency of a multistage chiller. In a chiller with a 2-stage compressor, the expansion process can be separated into 2 steps with an economizer chamber between.

period one

Components

notes

Liquid refrigerant from the condenser enters the first expansion device, which reduces the pressure of the refrigerant to that of the second-stage impeller inlet. This pressure drop causes a portion of the liquid refrigerant to evaporate, or flash, and the resulting mixture of liquid and vapor enters the economizer chamber. Here, the vapor is separated from the mixture and is routed directly to the inlet of the second stage impeller. The remaining liquid travels on to the second expansion device and evaporator.

Just before entering the evaporator, the liquid refrigerant flows through a second expansion device that reduces its pressure and temperature to evaporator conditions.

Flashing a portion of the refrigerant prior to the economizer reduces the amount of compressor power required, since the refrigerant vapor generated in the economizer only needs to be compressed by the second-stage impeller.

The benefit of the economizer will be discussed in greater detail in Period 2.

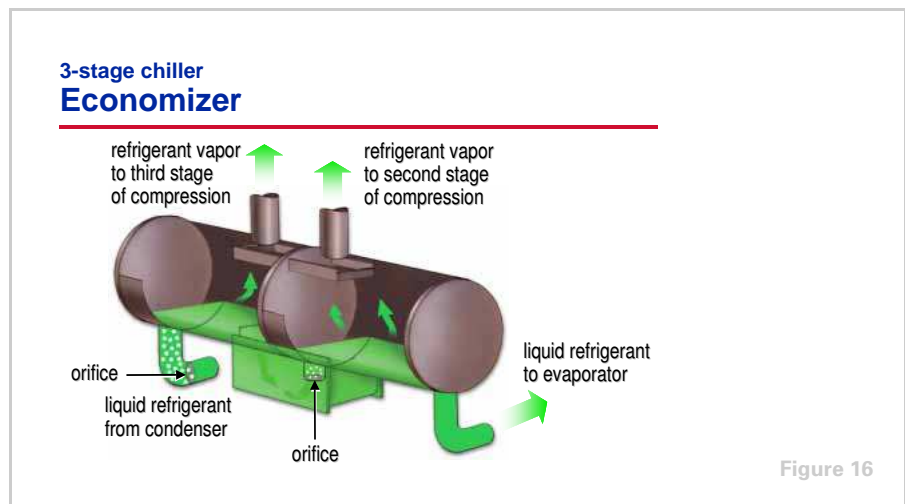

In a chiller with a 3-stage compressor, the expansion process can be separated into 3 steps with separate economizer chambers between the steps.

Liquid refrigerant from the condenser enters the first orifice (expansion device), which reduces the pressure of the refrigerant to that of the third-stage impeller inlet. This pressure drop causes a portion of the liquid refrigerant to flash, and the resulting mixture of liquid and vapor enters the high-pressure chamber of the economizer. Here, the vapor is separated from the mixture and is then routed directly to the inlet of the third-stage impeller. The remaining liquid travels on to the second expansion device.

The second expansion device further reduces the pressure of the refrigerant to that of the second-stage impeller inlet. This pressure drop causes a portion of the liquid refrigerant to flash, and the resulting mixture of liquid and vapor enters the low-pressure chamber of the economizer. Here, the vapor is separated from the mixture and routed directly to the inlet of the second-stage impeller. The remaining liquid travels on to the third expansion device and evaporator.

period one

Components

notes

Again, the final expansion device reduces the pressure and temperature of the refrigerant to evaporator conditions.

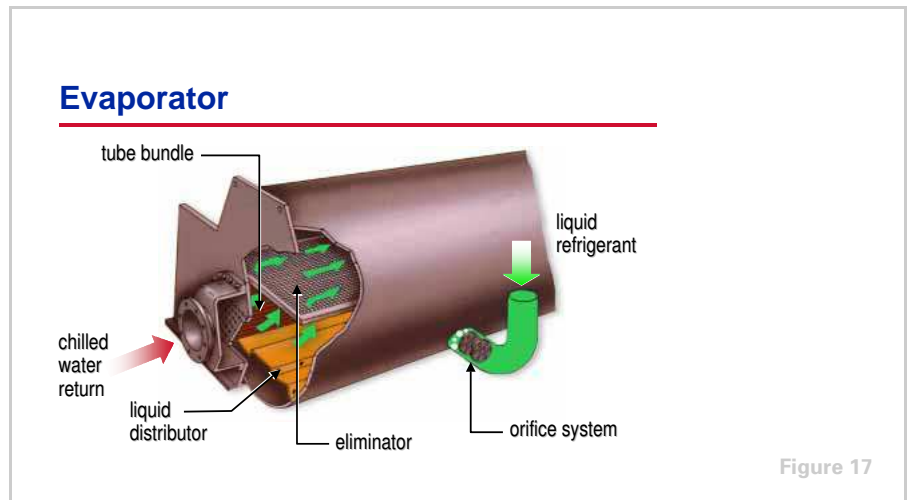

Evaporator

In the **flooded shell-and-tube evaporator** shown, the low-pressure mixture of liquid refrigerant and refrigerant vapor enters the distribution system that runs the entire length of the shell. Small openings and baffles in the passage of the liquid distributor provide an even spray of refrigerant over the surfaces of the tubes inside the evaporator shell, where the refrigerant absorbs heat from relatively warm water flowing through the tube bundle. This transfer of heat boils the liquid refrigerant on the tube surfaces. The resulting vapor passes through an eliminator that prevents liquid from being drawn upward. The vapor collects in a large chamber at the top of the shell and is drawn back to the compressor. The now-cool water can be used in a variety of comfort or process applications.

Some chiller designs may make use of a **direct expansion (DX) shell-and-tube evaporator**. In this type of evaporator, liquid refrigerant flows through the tubes and water fills the surrounding shell. As heat is transferred from the water to the refrigerant, the refrigerant boils inside the tubes and the resulting vapor is drawn to the compressor.

period one

Components

notes

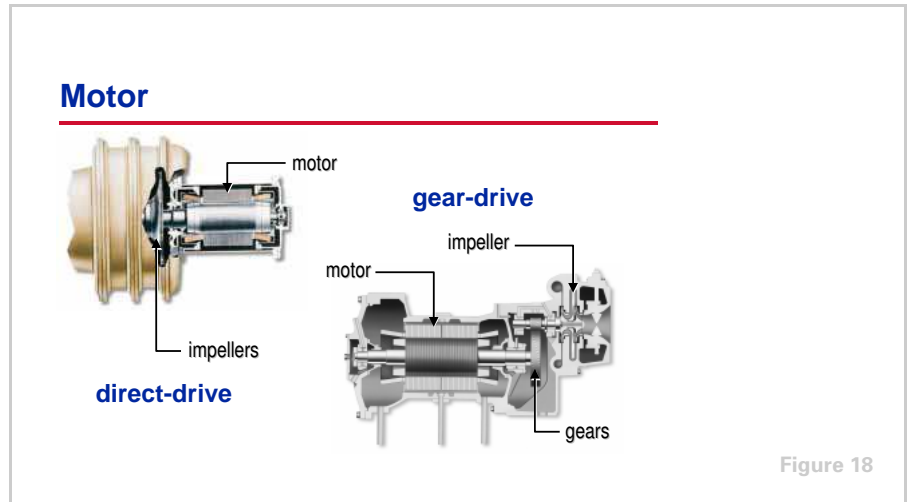

Motor

A motor is used to rotate the impeller(s). A **direct-drive motor** is connected directly to the impeller shaft and the impeller rotates at the same speed as the motor. A **gear-drive motor** transfers its energy to the impeller shaft using a set of gears. This allows the impeller to rotate at a higher speed than the motor.

The direct-drive motor requires fewer bearings and does not incur gear losses. Additionally, since the compressor rotates at a lower speed, it can be much quieter.

Direct-drive compressors are, however, only practical in centrifugal chillers that use low-pressure refrigerants.

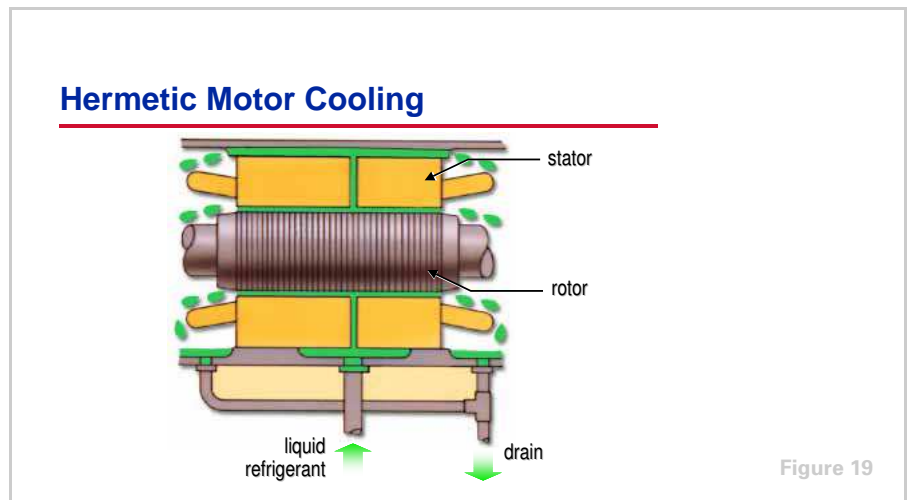

Another important difference in compressor motors is the issue of hermetic versus open. A **hermetic motor** is totally enclosed within the chiller's refrigeration system. An **open motor** is mounted externally—outside of the

period one

Components

notes

chiller's refrigeration system—and uses a coupling to connect the motor and compressor shafts.

The heat generated by the hermetic motor is absorbed by liquid refrigerant that flows around, through, and over the motor. The heat must be rejected by the chiller's condenser.

The heat generated by the open motor is rejected to the air drawn in from the equipment room. This heat must still be rejected from the equipment room, either by mechanical ventilation or, if the room is conditioned, the building's cooling system. In some designs, this air is simply drawn into the motor housing by the rotating motor shaft. The vent passages tend to get dirty and clog, resulting in higher operating temperatures and hot spots that adversely affect motor efficiency and reliability. Other designs, such as totally-enclosed fan-cooled (TEFC) and totally-enclosed air-over (TEAO), use a separate fan with a protective housing to cool the motor.

Hermetic compressor motors eliminate the need for the shaft couplings and external shaft seals that are associated with open motors. The coupling needs precise alignment, and these seals are a prime source of oil and refrigerant leaks. On the other hand, if a motor burns out, a hermetic chiller will require thorough cleaning, while a chiller with an open motor will not.

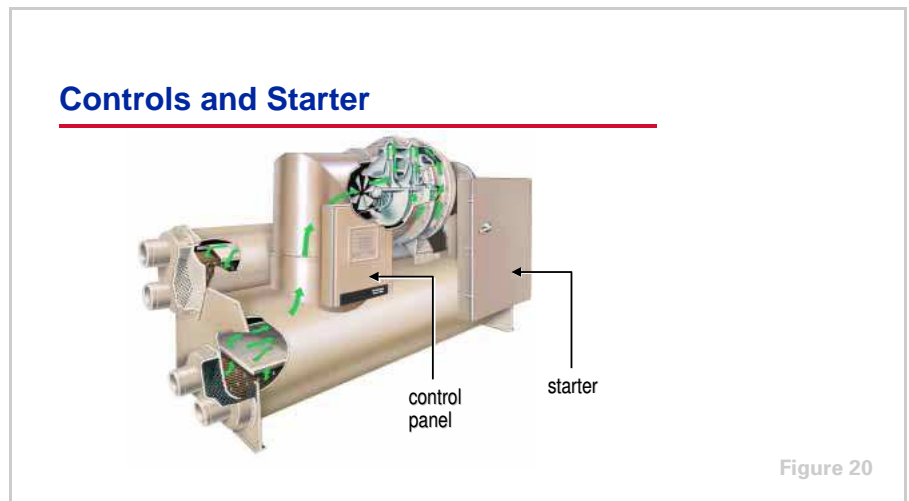

Controls and Starter

A microprocessor-based **control panel** is provided on the chiller to provide accurate chilled-water control as well as monitoring, protection, and adaptive limit functions. These controls monitor chiller operation and prevent the chiller from operating outside its limits. They can compensate for unusual operating conditions, keeping the chiller running by modulating system components rather than simply shutting it down when a safety setting is violated. When serious problems occur, diagnostic messages aid troubleshooting.

Modern control systems not only provide accurate, optimized control and protection for the chiller, but can also interface with a building automation system for integrated system control. In a chilled water system, optimal

period one

Components

notes

performance is a system-wide issue, not just a matter of chiller design and control.

A **starter** links the chiller motor and the electrical distribution system. Its primary function is to connect (start) and disconnect (stop) the chiller from line power—similar to what a switch does for a light bulb. The starter, however, handles much more current and must have the appropriate interlocks to work with the chiller control panel and oil pump.

Every electrically driven chiller requires a starter. It must be compatible with the characteristics of both the compressor motor and the electrical circuitry of the chiller. There are many types of starters, including star-delta, across-the-line, auto-transformer, primary reactor, and solid state. A variable-speed drive, which is used to modulate the speed of the motor during normal operation, also serves as a starter. Important characteristics to consider when selecting a starter include first cost, reliability, line voltage, and available current.

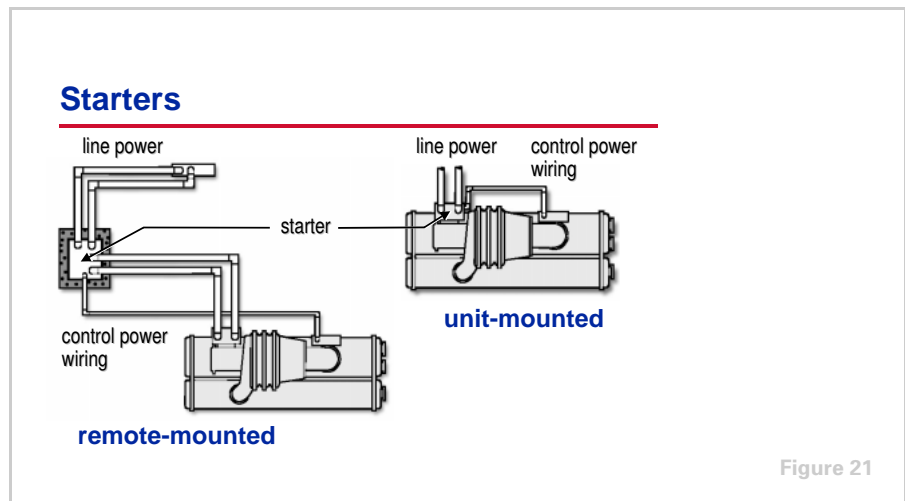

Figure 21

The starter may be mounted on, or remotely from, the chiller. Use of a unit-mounted starter reduces electrical installation costs. It may also improve reliability and save system design time, since all of the components are pre-engineered and factory mounted.

Depending on the type of starter selected, there are several options that can simplify installation. Disconnects allow the starter to be isolated from the electrical distribution system, and short-circuit protection can be provided using fuses or a circuit breaker.

period two

Refrigeration Cycle

notes

Centrifugal Water Chillers

period two

Refrigeration Cycle

Figure 22

A pressure–enthalpy ($p-h$) chart illustrates the refrigeration cycle of the centrifugal water chiller.

2-stage centrifugal chiller Refrigeration Cycle

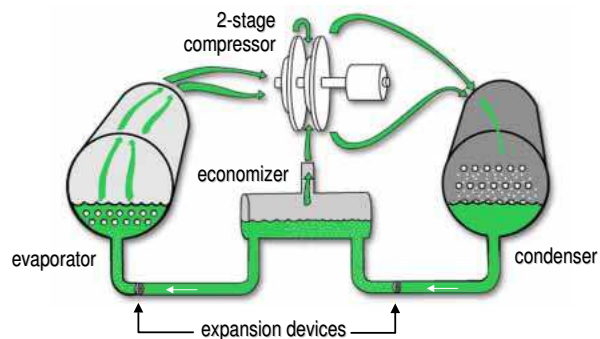

Figure 23

First, let's review the components of a 2-stage centrifugal chiller in the context of the refrigeration cycle.

Refrigerant vapor leaves the evaporator and flows to the compressor, where it is compressed to a higher pressure and temperature. High-pressure refrigerant vapor then travels to the condenser where it rejects heat to water, and then leaves as a saturated liquid. The pressure drop created by the first expansion device causes part of the liquid refrigerant to evaporate and the resulting mixture of liquid and vapor enters the economizer. Here, the vapor is separated from the mixture and routed directly to the inlet of the second-stage impeller. The remaining saturated liquid refrigerant enters the second expansion device.

period two

Refrigeration Cycle

notes

The pressure drop created by the second expansion device lowers the pressure and temperature of the refrigerant to evaporator conditions, causing a portion of the liquid refrigerant to evaporate. The resulting mixture of liquid and vapor enters the evaporator. In the evaporator, the liquid refrigerant boils as it absorbs heat from water and the resulting vapor is drawn back to the compressor to repeat the cycle.

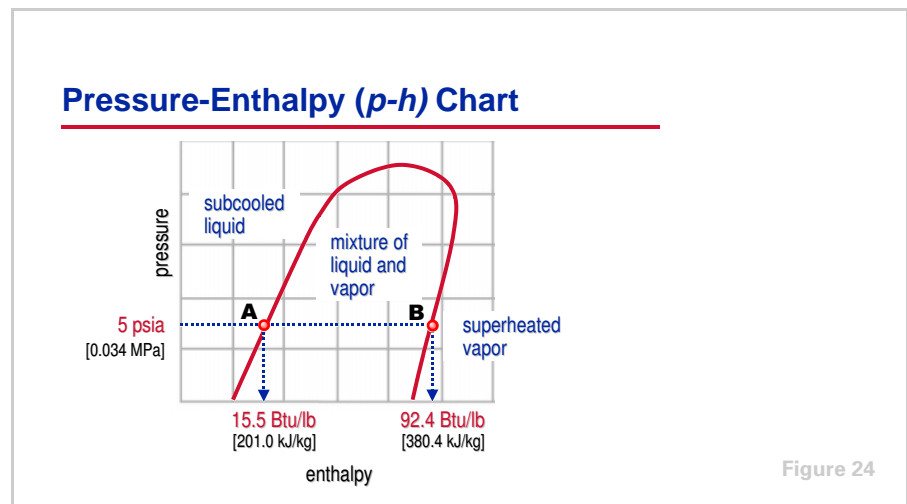

The **pressure-enthalpy chart** plots the properties of a refrigerant—refrigerant pressure (vertical axis) versus enthalpy (horizontal axis). **Enthalpy** is a measure of the heat content, both sensible and latent, per pound [kg] of refrigerant.

For example, **A** represents the heat content of saturated *liquid* HCFC-123 refrigerant at 5 psia [0.034 MPa] and 34°F [1.1°C]. **B** represents the heat content of saturated *vapor* HCFC-123 refrigerant at the same pressure and temperature. The difference in heat content, or enthalpy, between **A** and **B**—that is, 76.9 Btu/pound [179.4 kJ/kg]—is the amount of heat required to transform 1 pound of saturated liquid refrigerant to saturated refrigerant vapor at the same pressure and temperature.

If the heat content of the refrigerant at any pressure falls to the right of the curve, the vapor is superheated. Similarly, if the heat content of the refrigerant falls to the left of the curve, the liquid is subcooled. Finally, when the heat content of the refrigerant falls inside the curve, the refrigerant exists as a mixture of liquid and vapor.

Let's plot the theoretical vapor-compression refrigeration cycle for a 2-stage centrifugal water chiller on a pressure-enthalpy chart.

period two

Refrigeration Cycle

notes

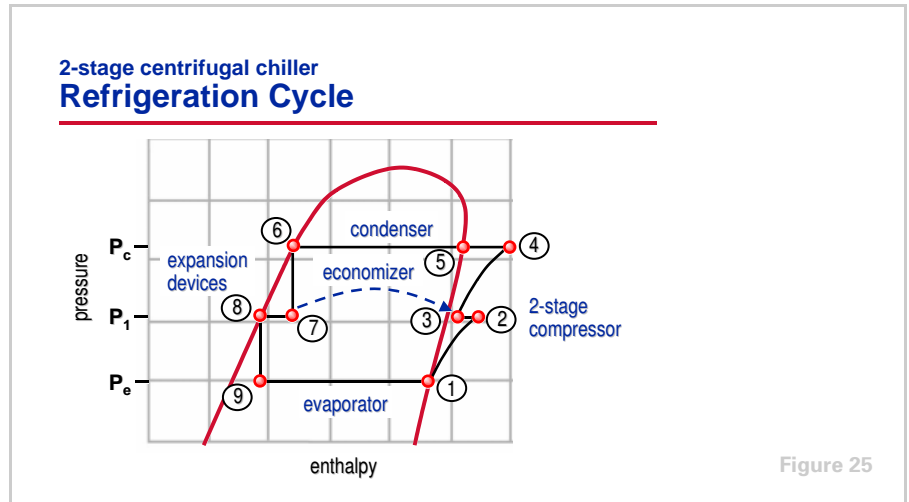

Refrigerant leaves the evaporator as saturated vapor ① and flows to the first-stage impeller of the compressor. There, the refrigerant vapor is compressed to a higher pressure (P_1) and temperature ②. Cooler refrigerant vapor that flashed within the economizer is mixed with the refrigerant discharged from the first-stage impeller, reducing the heat content of the mixture ③. The second stage of compression further elevates the pressure (P_c) and temperature of the refrigerant ④.

Energy provided to the compressor is imparted to the refrigerant as an increase in pressure and superheat. Superheated refrigerant vapor leaves the compressor and enters the condenser.

Water flowing through the condenser absorbs heat from the hot, high-pressure refrigerant vapor, causing it to desuperheat ⑤ and condense into saturated liquid ⑥ before leaving the condenser to travel to the first expansion device.

The first expansion device reduces the pressure (⑥ to ⑦) of the refrigerant to the second-stage impeller inlet pressure (P_1). This pressure drop causes a portion of the liquid refrigerant to evaporate, or flash. The evaporating refrigerant absorbs heat from the remaining liquid refrigerant, reducing its enthalpy from ⑦ to ⑧. The resulting mixture of liquid and vapor enters the economizer ⑦. Here, the vapor is separated from the mixture and routed directly to the second-stage impeller inlet ③ and the remaining liquid travels on to the second expansion device ⑨.

Just before it enters the evaporator, the liquid refrigerant flows through a second expansion device that reduces its pressure (P_e) and temperature to evaporator conditions ⑨. The cool, low-pressure mixture of liquid and vapor enters the distribution system in the evaporator shell and absorbs heat from water that flows through the tubes. This transfer of heat boils the liquid refrigerant, and the resulting saturated refrigerant vapor is drawn back to the compressor ① to repeat the cycle.

period two

Refrigeration Cycle

notes

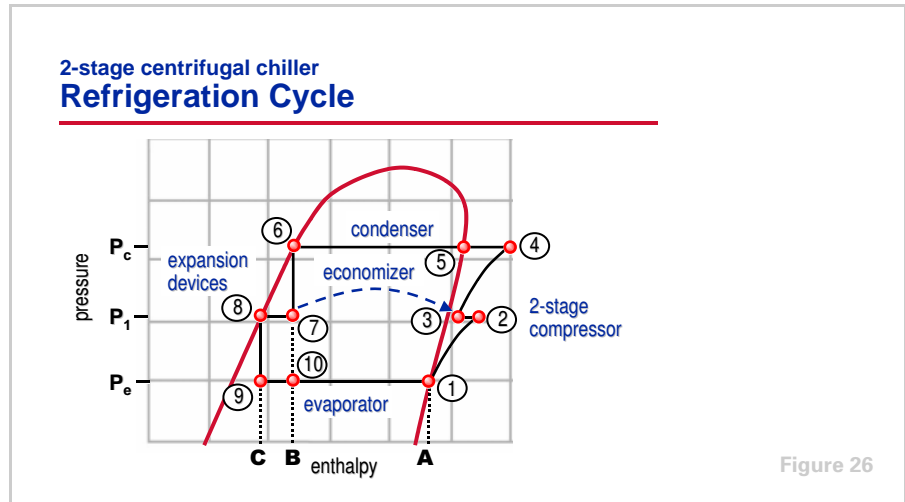

The change in enthalpy from **C** to **A** that occurs during the refrigeration cycle is called the **refrigeration effect**. This is the amount of heat that each pound [kg] of liquid refrigerant will absorb when it evaporates.

The benefit of the economizer can be demonstrated by comparing the refrigeration cycles with and without an economizer.

Without an economizer, refrigerant from the condenser ⑥ expands directly to evaporator conditions ⑩, producing a smaller refrigeration effect (**B** to **A**). Some chiller designs may subcool the liquid refrigerant in the condenser (⑥ moves to the left) to increase this refrigeration effect.

Also, in a chiller without an economizer, all of the refrigerant vapor must go through both stages of compression to return to condensing conditions. In a chiller with an economizer, refrigerant vapor that flashes in the economizer bypasses the first stage of compression, resulting in an overall energy savings of 3 to 4 percent.

period two

Refrigeration Cycle

notes

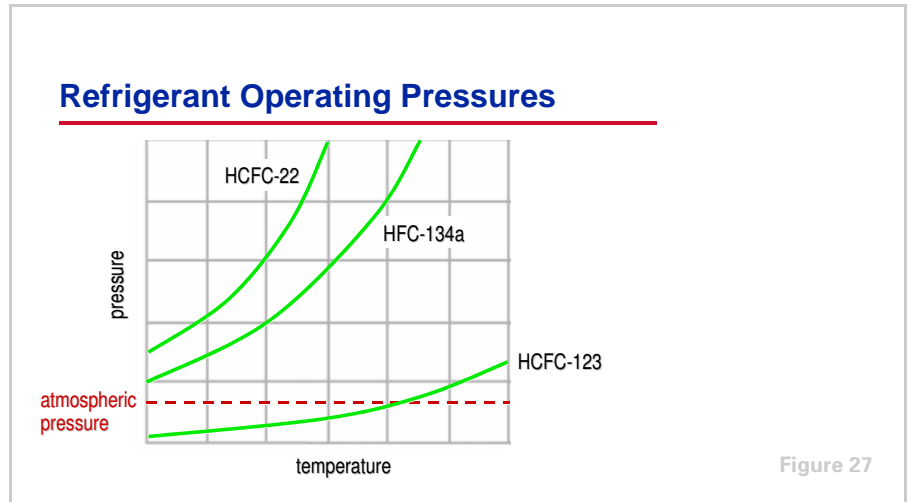

Refrigerants

When selecting which refrigerant to use in a centrifugal water chiller, the manufacturer considers efficiency, operating pressures, compatibility with materials, heat transfer properties, stability, toxicity, flammability, cost, availability, and environmental impact.

Refrigerants commonly used in centrifugal chillers can be classified as low, medium, or high pressure based on the normal operating pressures in the refrigeration cycle.

Chillers using a high-pressure refrigerant like HCFC-22, or a medium-pressure refrigerant like HFC-134a, operate at pressures that are well above atmospheric pressure. As we are about to see, some sections of chillers that use a low-pressure refrigerant such as HCFC-123 operate at below-atmospheric pressure.

period two

Refrigeration Cycle

notes

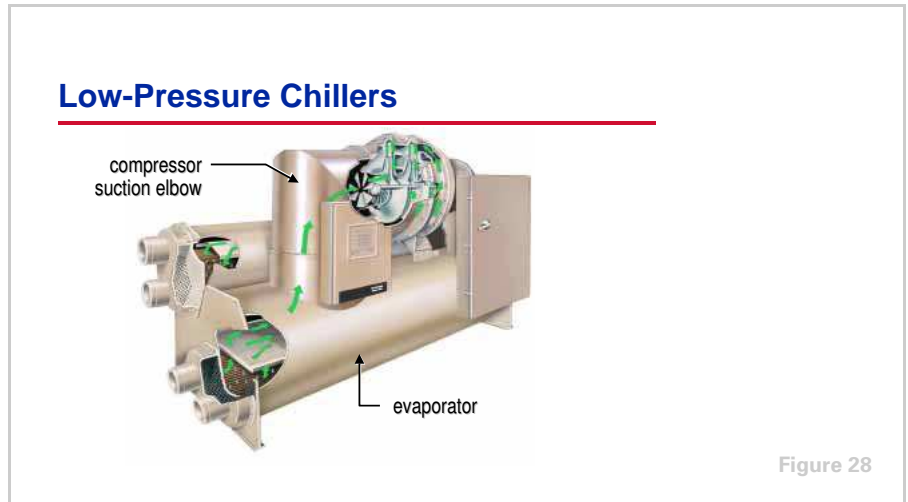

In chillers designed to use a low-pressure refrigerant, the evaporator and the piping leading to the suction side of the compressor operate at pressures that are lower than atmospheric pressure. Therefore, if small leaks exist in either of these sections, air will leak into the chiller instead of refrigerant leaking out.

Air inside a chiller reduces the surface area available for heat transfer. It also increases the refrigerant pressure in the condenser, which increases the pressure difference required across the compressor and causes more power to be consumed. In extreme cases, air can cause the compressor to surge, limiting the chiller's ability to produce cold water. Finally, infiltration of moist air can cause corrosion and other harmful chemical reactions inside the chiller.



Purge System

Low-pressure chillers typically include a **purge system** to remove air and moisture that may leak in, while minimizing the emission of refrigerant.

period two

Refrigeration Cycle

notes

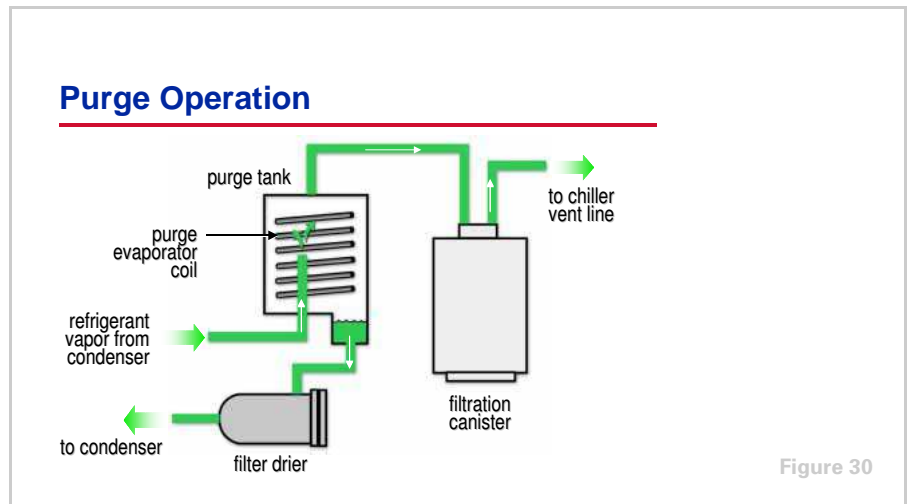

The purge consists of a small refrigeration system, a pump-out system, controls, and a filter drier. The purge's refrigeration system includes a small compressor, a finned-tube air-cooled condensing coil, an expansion valve, and an evaporator coil inside of the purge tank.

The tank with the evaporator coil separates condensable refrigerant from noncondensable air. Because the purge evaporator operates at a lower temperature and pressure than the chiller condenser, a mixture of refrigerant vapor and air is drawn from the chiller condenser, just above the level of the liquid refrigerant. (This is where air typically concentrates in a low-pressure chiller.) The mixture enters the purge tank, and the refrigerant condenses on the cold evaporator tubes and returns to the chiller condenser as liquid. The air does not condense but instead accumulates in the top of the tank. Eventually, enough air accumulates to cover a large portion of the coil. The air insulates the coil, reducing the amount of heat transferred and the temperature of the refrigerant leaving the purge evaporator coil. This temperature is called the purge suction temperature. The drop in purge suction temperature signals the need for a pump-out sequence.

When the purge suction temperature drops below the set point, a controller turns on the pump-out compressor and opens the isolation valves. Since the air contains a very small amount of refrigerant, it is pumped from the purge tank into a filtration canister. This canister adsorbs nearly all of the remaining refrigerant, and the air is then piped to the chiller vent line. When the purge suction temperature rises again, the controls close the valves and turn off the pump-out compressor.

A filter drier is located in the refrigerant drain line, between the purge tank and the chiller condenser. The filter drier removes moisture, acid, and dirt from the liquid refrigerant before it returns to the condenser.

The purge controls can also be used to track and record how often pump-out occurs. Leaks can be detected early by comparing pump-out activity over the last 24 hours to the 30-day average.

period three

Compressor Capacity Control

notes

Centrifugal Water Chillers

period three

Compressor Capacity Control

Figure 31

The capacity of most centrifugal compressors is controlled by vanes at the inlet of the compressor impeller.

While a survey of other centrifugal compressor designs shows that there are various methods of capacity control, many of them function in a manner similar to the inlet vanes presented in this period.

Inlet Vanes



Figure 32

Inlet vanes, installed ahead of the impeller, are a common method of modulating the capacity of the compressor over a wide range of load conditions (refrigerant flow rates). These vanes “preswirl” the refrigerant before it enters the impeller. By changing the refrigerant’s angle of entry, inlet vanes lessen the ability of the impeller to take in the refrigerant. As a result, each inlet vane position creates a new compressor performance characteristic without changing the rotational speed of the impeller.

period three

Compressor Capacity Control

notes

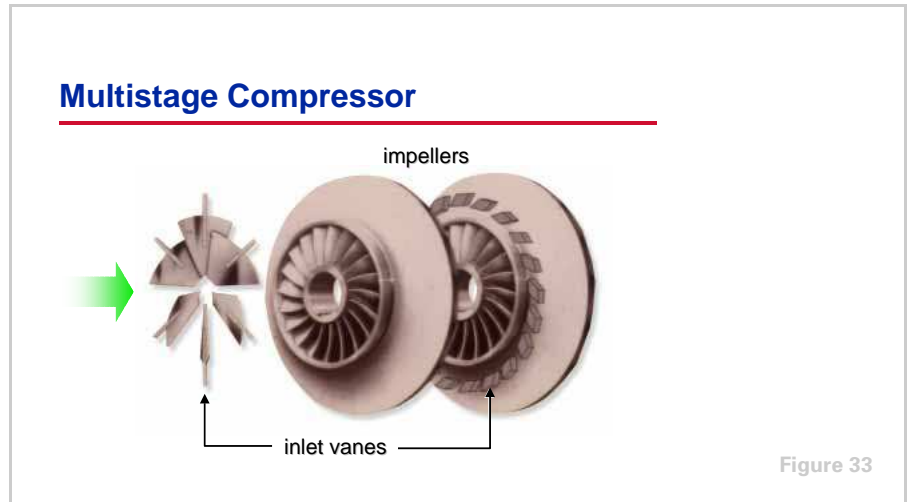

In a **multistage centrifugal compressor**, the operating characteristics of each impeller are modulated by the impeller's own set of inlet vanes.

This example shows 2 impellers in series. These impellers share the task of compressing the refrigerant. Centrifugal water chillers are generally available with 1, 2, or 3 impellers.

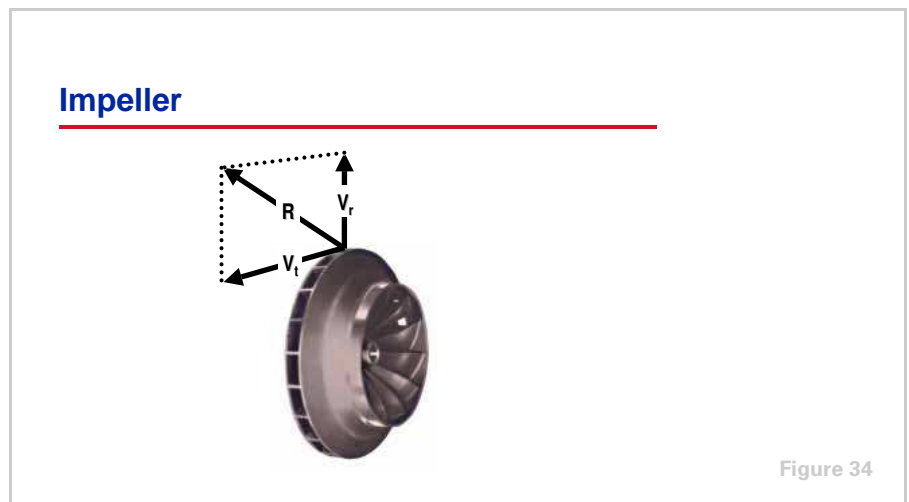

The forces that act on the refrigerant vapor within the centrifugal compressor impeller can be broken down into 2 components. One component acts to move the refrigerant away from the impeller in a radial direction. This component is called **radial velocity (V_r)**.

The second component acts to move the refrigerant in the direction of impeller rotation. This component is called **tangential velocity (V_t)**.

Together, these components generate the **resultant velocity vector (R)**, the length of which is proportional to the amount of kinetic energy in the

period three

Compressor Capacity Control

notes

refrigerant. Recall that kinetic energy is converted to static energy, or static pressure.

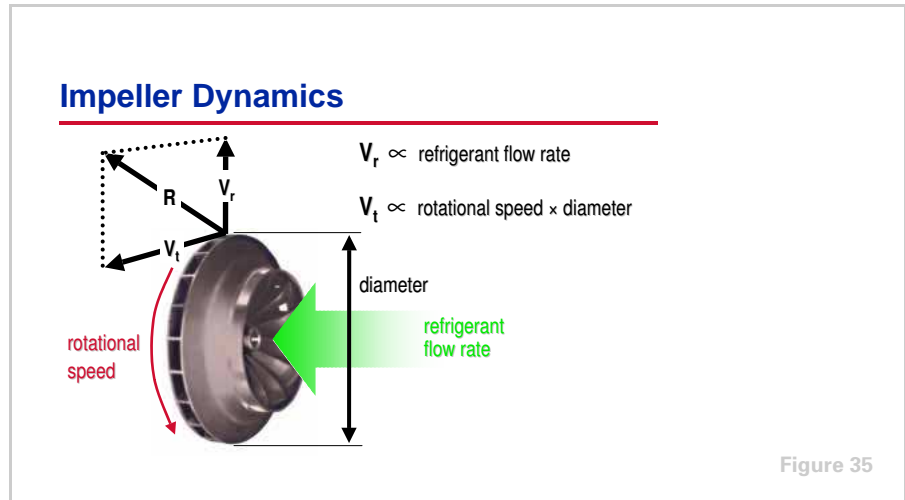

The radial velocity (V_r) for a given compressor is directly proportional (\propto) to the flow rate of refrigerant vapor through the compressor.

The tangential velocity (V_t) is proportional to the product of impeller rotational speed and impeller diameter.

Therefore, the static-pressure-producing capacity of a compressor can be adjusted by changing the flow rate of refrigerant, the impeller speed, or the diameter of the impeller.

period three

Compressor Capacity Control

notes

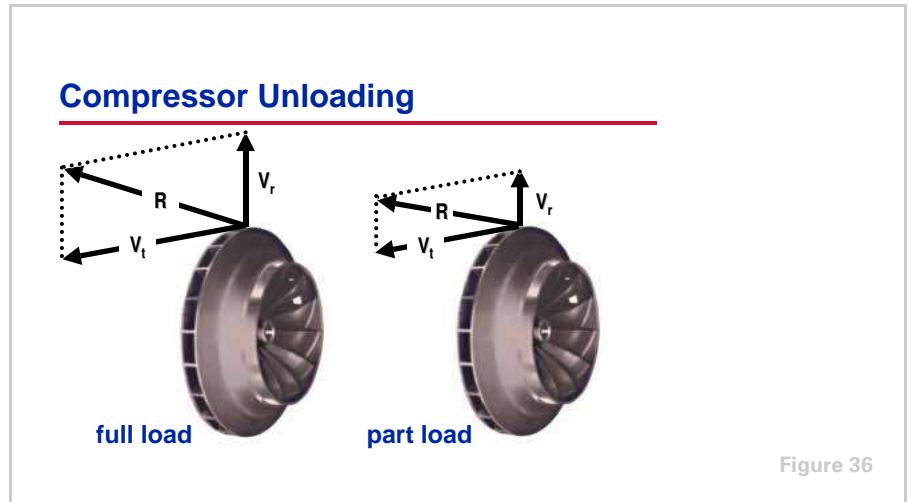

Consider a given-diameter compressor impeller that rotates at a constant speed. As the load on the chiller decreases, the inlet vanes partially close and the flow rate of refrigerant through the compressor drops. Radial velocity (V_r), which is proportional to refrigerant flow, decreases as well.

Even though the speed of rotation and diameter of the impeller are constant, the tangential velocity (V_t) (which is proportional to the product of impeller rotational speed and impeller diameter) drops because of the pre-swirling of the refrigerant caused by the inlet vanes.

The result is a shorter resultant velocity vector (R), which means that less static pressure is generated.

period three

Compressor Capacity Control

notes

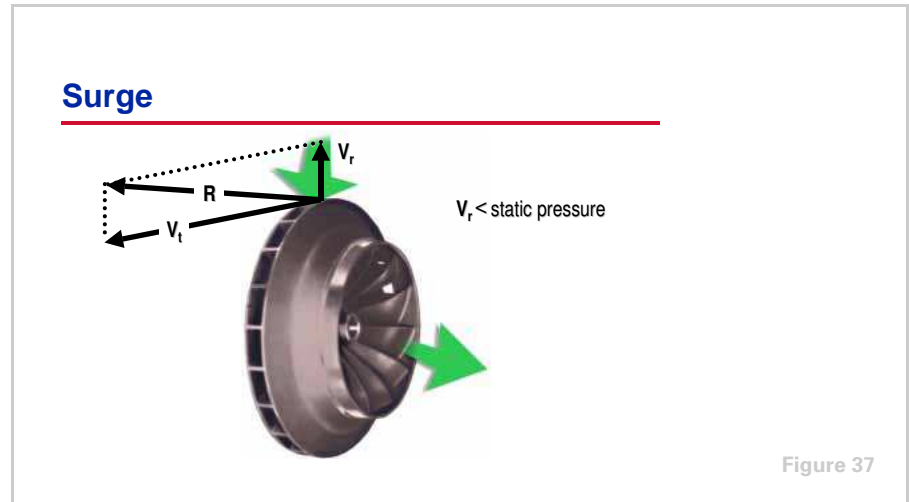

As the load and the corresponding refrigerant flow rate continue to fall, the radial velocity (force) drops, too. At some point, the radial force becomes smaller than the generated static pressure, letting the pressurized refrigerant vapor flow backward from the diffuser passages into the impeller. This instantaneously reduces the pressure within the passages below the radial force and the compressor is able to re-establish the proper direction of refrigerant flow.

This condition is known as **surge**. So long as this unstable load condition exists, the refrigerant alternately flows backward and forward through the compressor impeller, generating noise and vibration.

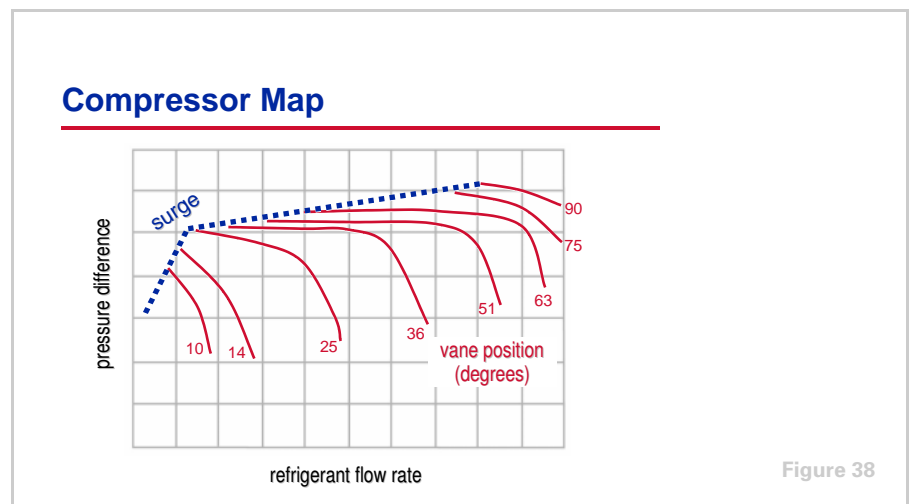

These curves represent the performance of a typical 2-stage compressor over a range of inlet vane positions. The pressure difference between the compressor inlet (evaporator) and outlet (condenser) is on the vertical axis and the refrigerant flow rate is on the horizontal axis. The dashed line represents the

period three

Compressor Capacity Control

notes

conditions that cause the compressor to surge. Any operating point that falls to the right of this line is satisfactory for stable operation.

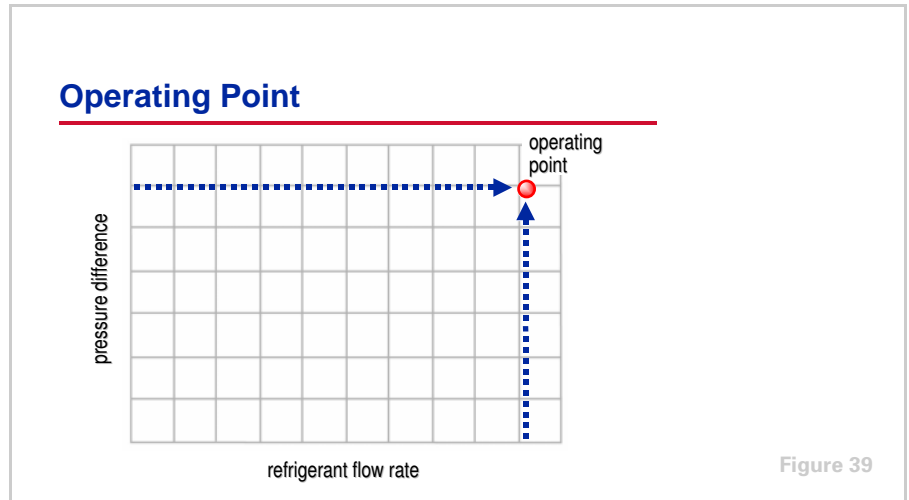

To balance the load on the chiller, the compressor must pump a certain quantity of refrigerant vapor at evaporator pressure and elevate it to the pressure dictated by the condensing conditions.

The intersection of the refrigerant flow rate and the pressure difference between the inlet and outlet of the compressor identifies the compressor **operating point**.

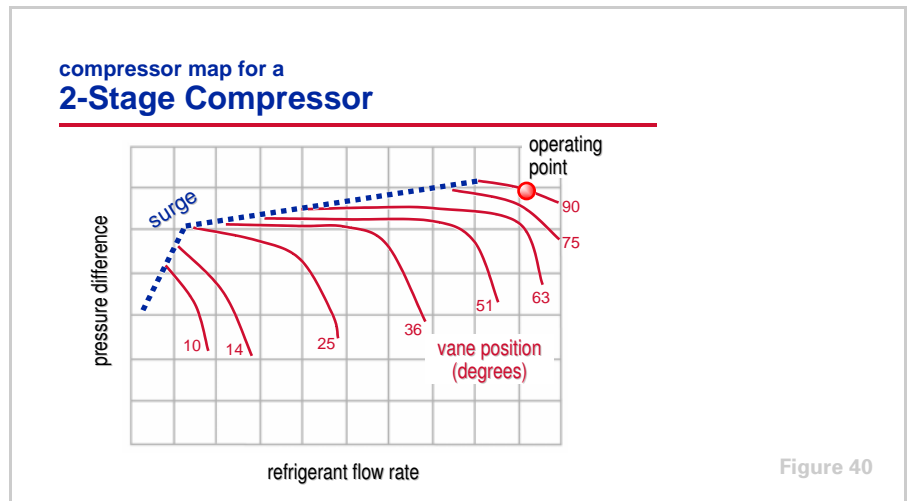

Superimposing the operating point on the previous compressor performance curves establishes the point at which the compressor will balance the load. In this example, the compressor will balance the load with its inlet vanes open 90°.

period three

Compressor Capacity Control

notes

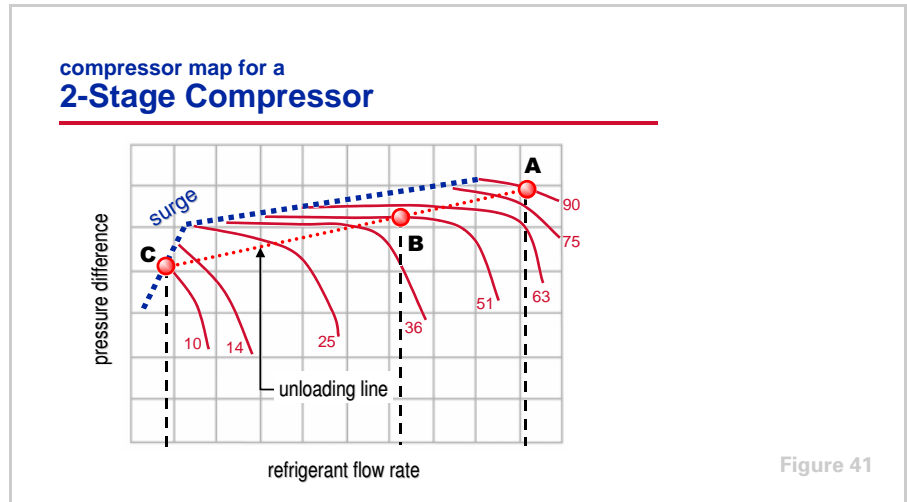

The starting point **(A)** is the full-load operating point. As the load on the chiller decreases, the inlet vanes partially close, reducing the flow rate of refrigerant vapor through the compressor and balancing the chiller capacity with the new load **(B)**.

Less refrigerant, and therefore less heat, is transferred to the condenser. Since the heat rejection capacity of the condenser is now greater than required, the refrigerant condenses at a lower temperature and pressure. This reduces the pressure difference between the evaporator and the condenser.

Continuing along the unloading line, the compressor remains within its stable operating range until it reaches the surge region at **C**.

period three

Compressor Capacity Control

notes

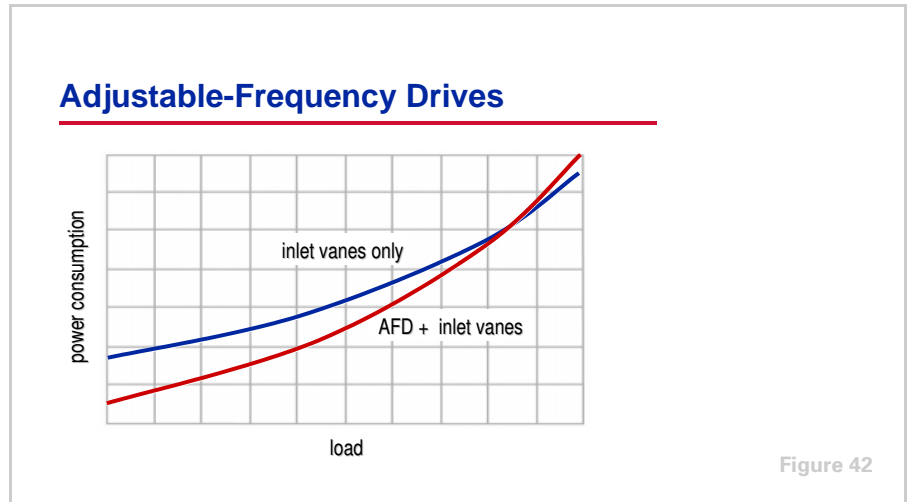

An **adjustable-frequency drive (AFD)**, or variable-speed drive, is another device used to vary the capacity of a centrifugal compressor. AFDs are widely used with fans and pumps, and with the advancement of microprocessor-based controls for chillers, they are now being applied to centrifugal water chillers.

Using an AFD with a centrifugal chiller can degrade the chiller's full-load efficiency. It will, however, offer energy savings by reducing motor speed at low-load conditions when cooler condenser water is available. An AFD also controls the inrush current at start-up, reducing stress on the compressor motor.

Certain system characteristics favor the application of an adjustable frequency drive, including:

- A substantial number of part-load operating hours
- The availability of cooler condenser water
- Chilled-water reset control
- High electrical charges

Performing a comprehensive energy analysis is the best method of determining if an adjustable-frequency drive is desirable. Depending on the application, it may make sense to take the additional money needed to purchase an AFD and use it to purchase a more efficient chiller instead.

period four

Maintenance Considerations

notes

Centrifugal Water Chillers

period four

Maintenance Considerations

Figure 43

This period discusses general maintenance requirements of centrifugal water chillers. Although some of the information applies specifically to the design presented in this clinic, requirements for other centrifugal chiller designs are also included.

Maintenance Considerations

- ▲ Operating log
- ▲ Mechanical components
- ▲ Heat-transfer surfaces
- ▲ Fluid analysis

Figure 44

Once a centrifugal chiller is installed and put into operation, it usually continues to function without a full-time attendant. In many cases, the machine starts and stops on a schedule controlled by a building automation system or a simple time clock. The only daily maintenance requirement is to complete and review the operating log.

Water chillers are designed for maximum reliability with a minimum amount of maintenance. Like all large mechanical systems, however, certain routine maintenance procedures are either required or recommended.

period four

Maintenance Considerations

notes

operating log
ASHRAE Guideline 3

<ul style="list-style-type: none"> ▲ Chilled water inlet and outlet temperatures and pressures ▲ Chilled water flow ▲ Evaporator refrigerant temperature and pressures ▲ Evaporator approach temperature ▲ Condenser water inlet and outlet temperatures and pressures ▲ Condenser water flow ▲ Condenser refrigerant temperature and pressures ▲ Condenser approach temperature 	<ul style="list-style-type: none"> ▲ Oil pressures, temperature, and levels ▲ Addition of refrigerant ▲ Addition of oil ▲ Vibration levels
--	--



Figure 45

Guideline 3, “*Reducing Emission of Halogenated Refrigerants in Refrigeration and Air Conditioning Equipment and Systems,*” is one of several advisory documents published by the American Society of Heating, Refrigerating and Air-Conditioning Engineers (ASHRAE). This guideline includes a list of recommended data points to be logged daily for each chiller. Much of this data may be available from the display on the chiller control panel.

Special attention should be given to:

- Reviewing the operating log and trends
- Observing the oil pressure drop to determine if the oil filter needs to be replaced
- Monitoring evaporator and condenser approach temperatures
- Observing and recording the oil level
- Monitoring purge pump-out operation

period four

Maintenance Considerations

notes

maintenance considerations

Mechanical Components

▲ Required maintenance

- ◆ Compressor and motor: no maintenance required
- ◆ Controls: no maintenance or calibration required

▲ Recommended maintenance

- ◆ Visually inspect overall unit
- ◆ Inspect safety controls and electrical components
- ◆ Tighten electrical connections
- ◆ Check for leaks

Figure 46

The compressor/motor assembly in direct-drive, hermetic compressor designs requires little periodic maintenance. The hermetic motor eliminates the need for external shaft seals associated with open motors. (These seals are a prime source of oil and refrigerant leaks and should be inspected on a regular basis.) Hermetic motor designs also eliminate the annual coupling and seal inspections, alignment, and shaft seal replacement associated with open motors.

With the advent of microprocessor-based controls, the control panel and auxiliary controllers require no recalibration or maintenance. Remotely-mounted electronic sensors send information to the unit controller, which can be connected to a building automation system to communicate information and allow system-level optimization. These systems can notify the operator with an alarm or diagnostic message when a problem occurs.

As for any mechanical equipment, a daily visual inspection of the chiller is recommended to look for oil leaks, condensation, loosened electrical or control wiring, or signs of corrosion. Special attention should be given to safety controls and electrical components.

A qualified service technician should check the chiller annually for leaks. The United States Environmental Protection Agency (EPA) mandates refrigerant recovery whenever a refrigeration circuit is opened during the normal service of any air conditioning system.

period four

Maintenance Considerations

notes

maintenance considerations

Mechanical Components

▲ Other design-specific requirements

- ◆ Change oil when oil analysis dictates
- ◆ Replace oil filter periodically
- ◆ Replace filter drier periodically
- ◆ Clean oil strainers annually
- ◆ Check shaft alignment annually
- ◆ Check coupling annually
- ◆ Replace shaft seal every 2 to 4 years
- ◆ Compressor teardown inspection every 5 to 10 years

Figure 47

Some centrifugal compressor designs do require periodic maintenance of mechanical system components. This includes oil and refrigerant filter changes, oil strainer changes, and a compressor inspection.

Open-motor compressor designs require shaft alignment, coupling inspection, bearing lubrication, and cleaning of the motor windings on a quarterly or annual basis.

In all cases, strictly follow the maintenance requirements and recommendations published by the manufacturer.

maintenance considerations

Heat Transfer Surfaces

▲ Recommended maintenance

- ◆ Use a qualified water treatment specialist
- ◆ Clean condenser tubes as needed
- ◆ Clean water-side strainers
- ◆ Test tubes every 3 years

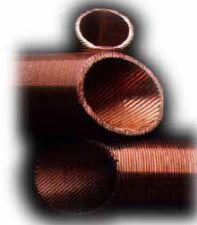

Figure 48

To ensure optimum heat transfer performance, the heat transfer surfaces must be kept free of scale and sludge. Even a thin deposit of scale can substantially reduce heat transfer capacity. Engage the services of a qualified water treatment specialist to determine the level of water treatment required to remove contaminants from the cooling tower water.

period four

Maintenance Considerations

notes

Scale deposits are best removed by chemical means. During this process, the water-cooled condenser is commonly isolated from the rest of the cooling-tower-water circuit by valves, while a pump circulates cleaning solution through the condenser tubes.

Sludge is removed mechanically. This typically involves removing the water boxes from the condenser and loosening the deposits with a stiff-bristled brush. The loosened material is then flushed from the tubes with clear water. As part of this procedure, the strainers in both the chilled-water and cooling-tower-water circuits should be cleaned every year.

Every 3 years (more frequently in process or critical applications), a qualified service organization should perform nondestructive inspections of the evaporator and condenser tubes. The eddy-current tube test is a common method.

Rarely, problems may arise that cause refrigerant or water leaks. These must be repaired immediately.

Fluid Analysis

▲ Oil analysis

- ◆ Conduct annual analysis to verify system integrity
- ◆ Measure oil pressure drop to determine if filter needs changing
- ◆ Measure charge

▲ Refrigerant charge

- ◆ Conduct analysis of refrigerant
- ◆ Inspect purge system



Figure 49

Oil analysis is an important annual maintenance task required for centrifugal water chillers. It may be conducted more frequently for chillers that run continuously or more often than normal. This test, performed by a qualified laboratory, verifies the integrity of the refrigeration system by testing the concentrations of moisture, acidity, and metal. This analysis can determine where problems exist or could potentially develop. By taking oil samples on a regular basis, normal operating trends for the compressor and bearing metals can be analyzed. Instead of adopting a “change the oil once a year whether it needs it or not” approach, regular oil analyses can be used to determine proper oil change intervals and predict major problems before they occur.

Refrigerant analysis measures contamination levels and determines suitability for continued use. It can also determine if recycled refrigerant is suitable for reuse. Refrigerant analysis helps extend the life of the existing charge and ensures that the chiller is operating at peak efficiency.

period four

Maintenance Considerations

notes

Regularly logging oil and refrigerant charges, and examining the trends of this data, can help identify potential problems before they occur.

Oil Analysis

▲ Why perform regular oil analysis?

- ◆ Helps reduce maintenance costs
- ◆ Detects problems without compressor disassembly
- ◆ Extends service life of oil charge
- ◆ Reduces environmental problems related to oil disposal
- ◆ Helps maintain compressor efficiency and reliability
- ◆ Helps lower refrigerant emissions



Figure 50

An oil analysis is a key preventive maintenance measure and should be conducted at least annually. It will help the compressor last longer while maintaining chiller efficiency and reducing refrigerant emissions.

A certified chemical laboratory can be contracted to perform the analysis for all types of compressors. Often the chiller manufacturer can provide this service.

period five
Application Considerations

notes

Centrifugal Water Chillers

period five

Application Considerations

Figure 51

Several considerations must be addressed when applying centrifugal water chillers, including:

- Condensing temperature control
- Constant or variable evaporator-water flow
- Short evaporator-water loops
- Heat recovery
- Free cooling
- Equipment certification standards

While not all-inclusive, this list of considerations does represent some of the key issues.

period five

Application Considerations

notes

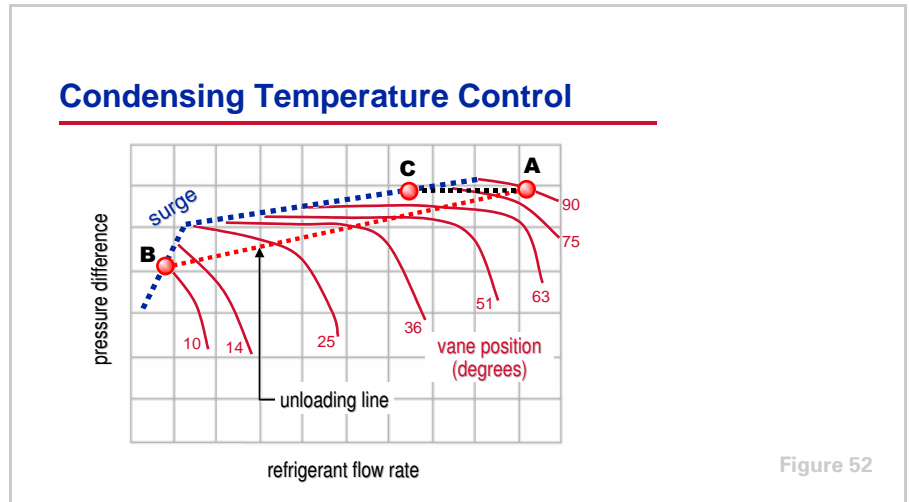

Condensing Temperature Control

To achieve stable compressor unloading over a wide range of conditions, a reduction in condensing pressure (condenser relief) must accompany a reduction in load.

The starting point (**A**) is the full-load operating point. As the chiller load decreases, the flow rate of refrigerant vapor through the compressor also decreases. In turn, the pressure difference between the evaporator and the condenser moves the operating point downward toward **B**.

If the condenser pressure had been controlled to a constant value instead, the compressor would have unloaded along a nearly constant pressure line toward **C**. This would result in a greatly reduced range of operation.

Condenser relief is, however, only beneficial to a certain point. ALL chillers require a minimum pressure difference between the evaporator and condenser to ensure proper management of oil and refrigerant. This minimum pressure difference depends on the chiller's design and controls. The most common method of maintaining this pressure difference at various load conditions is to control the condensing temperature by varying the temperature or flow rate of water through the condenser. By controlling condensing temperature, most centrifugal water chillers can start and operate over a wide range of conditions.

Controlling condensing temperature: (1) maintains chiller efficiency, (2) maintains the required pressure differential between the evaporator and condenser for controlled flow through the refrigerant metering system, and (3) prevents the pressure imbalance that could cause oil loss problems.

period five

Application Considerations

notes

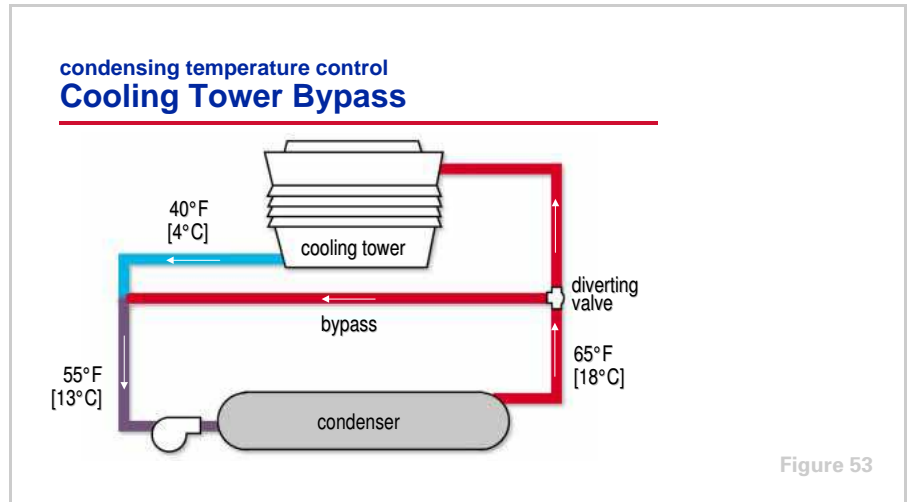

Controlling the refrigerant pressure difference between the evaporator and condenser of a water-cooled chiller is accomplished by varying the temperature or flow rate of the water flowing through the condenser. The following are 5 common methods used to control condensing temperature:

- 1) Cycling or varying the speed of the cooling tower fans to control the temperature of the water leaving the cooling tower
- 2) Using a cooling tower bypass pipe to mix warmer leaving-condenser water with the colder tower water and control the temperature entering the condenser as illustrated here
- 3) Modulating a throttling valve to restrict the flow of water through the condenser
- 4) Using a chiller bypass pipe to vary the flow rate of water through the condenser
- 5) Using a variable-speed drive on the condenser water pump to vary the water flow rate through the condenser

Each of these strategies has its advantages and disadvantages. Selecting the appropriate condensing temperature control scheme will depend on the specific requirements of the application.

The water flow rate through the chiller condenser must stay between the minimum and maximum condenser bundle flow rates specified by the chiller manufacturer.

period five

Application Considerations

notes

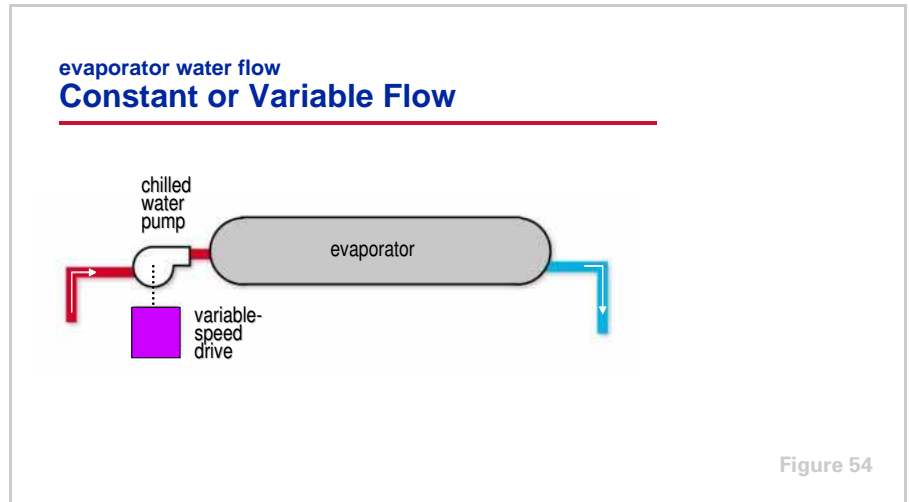

Constant or Variable Evaporator Water Flow

Previous chiller designs required that a constant flow rate of water be maintained through the evaporator. This requirement has changed due to advances in chiller controls. Increased sensing and control capabilities now allow chiller manufacturers to design controls that monitor, and respond faster to, fluctuating conditions.

While the chiller may be able to handle variable water flow through the evaporator, the specific application of the chilled water system may not warrant variable flow. As always, each application should be analyzed to determine if variable evaporator water flow is warranted.

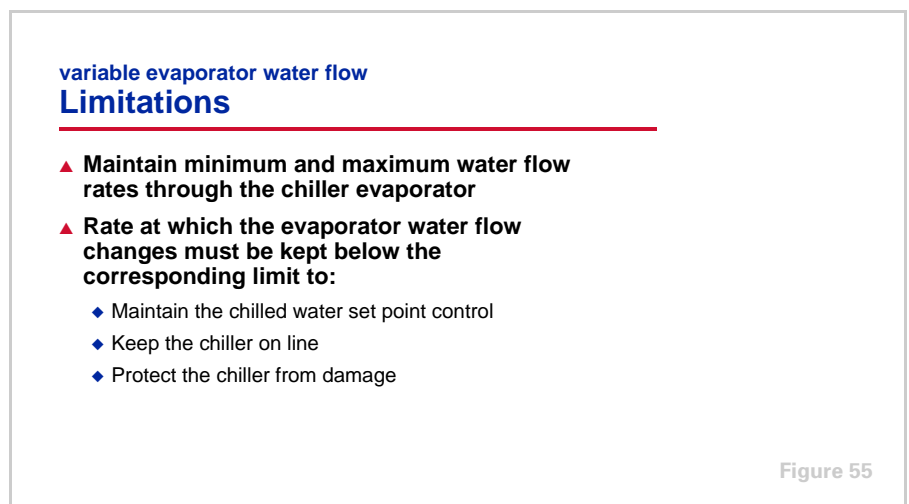

The controls on many current chiller designs can properly control the chiller in response to varying evaporator flow rates, with the following limitations:

period five

Application Considerations

notes

1) The water flow rate through the chiller evaporator must stay between the minimum and maximum flow rates for the evaporator bundle, as specified by the chiller manufacturer. These limits depend on the specific design variables of the actual evaporator bundle such as the number of tubes, number of passes, and geometry. Implementation of a method for sensing evaporator water flow through each chiller is the only way to make sure that the water flow rate stays within these limits.

2) The rate of change for the evaporator water flow rate must not exceed a specified level, depending on the level of protection desired. For example, the maximum rate of change to maintain the chilled water set point is more stringent than the maximum rate of change to keep the chiller on line. There are 3 common levels of protection desired: maintaining chilled water set point control, keeping the chiller on line, and protecting the chiller from damage.

The limits for these different levels of protection should be obtained from the chiller manufacturer.

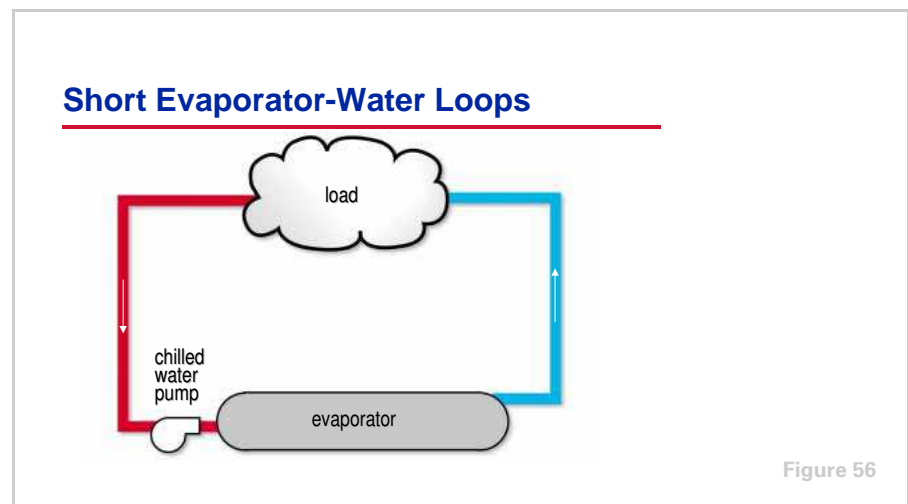

Short Evaporator-Water Loops

Proper chilled water temperature control requires that the temperature of the chilled water returning to the evaporator not change any faster than the chiller controls can respond. The volume of water in the evaporator loop acts as a buffer, ensuring that the return water temperature changes slowly and, therefore, providing stable temperature control. If there is not a sufficient volume of water in the loop to provide an adequate buffer, temperature control can be lost, resulting in erratic system operation.

The chiller manufacturer should be consulted for volume requirements of the evaporator-water loop.

period five

Application Considerations

notes

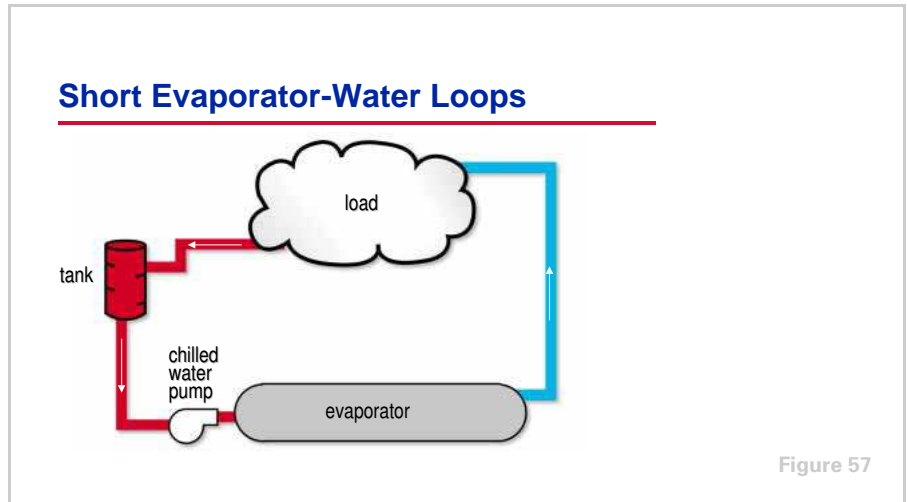

Short water loops may be unavoidable in close-coupled or very small applications, particularly in systems where the load consists of only a few air handlers or processes.

To prevent the effect of a short water loop, a storage tank or large header pipe can be added to the system to increase the volume of water in the loop and ensure a slowly changing return water temperature.

A second solution is to reduce the water flow rate in the chilled water loop while using the same size pipes. This also increases the loop time—the time it takes a particle of water to travel through the chilled water loop—and ensures that the return water temperature changes slowly. This solution has the added benefit of reduced pumping energy requirements.

period five
Application Considerations

notes



Heat Recovery

Salvaging usable heat from the refrigeration cycle—heat that would normally be rejected to the atmosphere—can significantly reduce the operating costs of many buildings.

Heat recovery is most commonly accomplished using 2 condensers and the fact that hot refrigerant vapor migrates to the area with the lowest temperature. Raising the refrigerant condensing temperature in the standard condenser prompts the refrigerant to flow instead to the second condenser, where it rejects its heat to the water flowing through the tubes. The condensing temperature in the standard condenser is controlled by varying the temperature or the flow rate of the cooling tower water.

Typical uses for the hot water from the second condenser include: heat for spaces around the perimeter of the building, reheat coils in air conditioning systems, and bathroom, laundry, or kitchen requirements. Any building with a simultaneous heating and cooling load is a potential candidate for heat recovery.

period five

Application Considerations

notes

Heat-Recovery Chiller Options

heat-recovery (dual) condenser	auxiliary condenser	heat pump
<ul style="list-style-type: none"> ◆ Second, full-size condenser ◆ Large heating loads ◆ High hot water temperatures ◆ Controlled ◆ Degrades chiller efficiency 	<ul style="list-style-type: none"> ◆ Second, smaller size condenser ◆ Preheating loads ◆ Moderate hot water temperatures ◆ Uncontrolled ◆ Improves chiller efficiency 	<ul style="list-style-type: none"> ◆ No extra condenser ◆ Large base heating loads or continuous operation ◆ High hot water temperatures ◆ Controlled ◆ Chiller efficiency preserved

Figure 59

Three types of heat-recovery chillers are commonly available:

The **dual-condenser**, or **double-bundle**, heat-recovery chiller contains a second, full-size condenser that serves a separate hot water loop. It is capable of more heat rejection and higher leaving-water temperatures. This type of chiller allows the amount of heat being rejected to be controlled, although chiller efficiency is sacrificed for higher hot water temperatures.

Similarly, an **auxiliary-condenser** heat-recovery chiller makes use of a second, smaller condenser bundle. It is not capable of rejecting as much heat as the dual-condenser chiller. Since its leaving-water temperatures are also lower, it is typically used to preheat returning hot water before it goes to the primary heating equipment or to preheat incoming water prior to entering a traditional water heater. It requires no additional controls and actually improves chiller efficiency.

A **heat-pump** chiller is a standard chiller (no extra shells are required) applied where the useful heat transfer occurs in the condenser, not the evaporator. The evaporator is connected to the chilled water loop, typically upstream of other chillers, but it only removes enough heat from the chilled water loop to handle the heating load served by the condenser water loop. This application is useful in a multiple-chiller installation, where there is a base or year-round comfort or process load, or where the quantity of heat required is significantly less than the cooling load. Chiller efficiency is not compromised.

period five

Application Considerations

notes

Free Cooling

air-side economizer

- ◆ Most efficient
- ◆ Requires larger outdoor air, return, and exhaust duct systems

strainer cycle

- ◆ Coldest water temperatures
- ◆ Potential fouling in chilled water loop
- ◆ Requires additional piping, valves, and controls

plate-and-frame heat exchanger

- ◆ Potential fouling limited to heat exchanger
- ◆ Requires additional heat exchanger, piping, valves, and controls
- ◆ Can operate simultaneously with chiller

Figure 60

Free Cooling

Many buildings require some form of year-round cooling to handle interior spaces or other loads. When the outdoor air temperature falls below the indoor dew point temperature, it is possible to use an **air-side economizer** to satisfy these cooling requirements. This method of “free cooling” involves using outdoor air for cooling instead of recirculating warmer indoor air. It is the most efficient method of free cooling because it allows all of the chilled water and/or refrigeration system components to be turned off. This method, however, requires larger duct systems to deliver the outdoor air to the air handler and to return and exhaust this larger amount of air.

A second method of applying free cooling is to pump water from the cooling tower loop directly into the chilled water loop when its temperature is low enough to satisfy the cooling load. This is commonly called the **strainer cycle** because a strainer or filter is needed to prevent debris and contaminants carried by the cooling tower water from entering the chilled water loop. Although this method is very efficient, the contamination common in open cooling tower systems causes concern about “fouling” (deposits of scale or sludge) inside the chilled water coils. Ongoing treatment of the chilled water loop is required.

Another method of providing free cooling is similar to the strainer cycle but involves the use of a **plate-and-frame heat exchanger**, or **water-side economizer**, to isolate the chilled water loop from the cooling tower loop. This is a popular method of free cooling because it is efficient and eliminates potential contamination of the chilled water loop. In addition, the heat exchanger can be operated simultaneously with the chiller.

period five
Application Considerations

notes

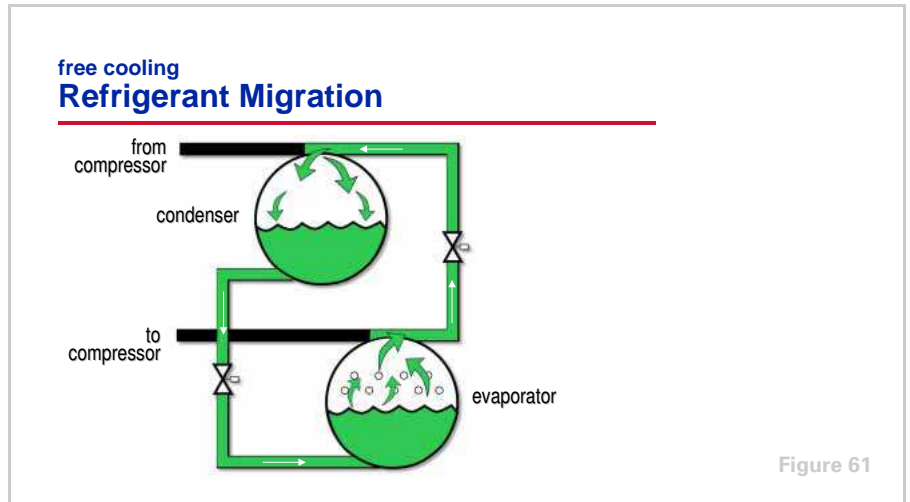

This leads to the discussion of a free cooling principle called **refrigerant migration**. It involves adapting a water chiller so that it functions as a simple heat exchanger.

When the available condenser water is cooler than the desired chilled water temperature, the compressor is turned off and bypass valves in the chiller refrigerant circuit are opened to let the refrigerant circulate without help from the compressor. Because refrigerant migrates to the area with the lowest temperature, refrigerant boils in the evaporator and the vapor flows to the cooler condenser bundle. After the refrigerant condenses, it flows (by gravity) back to the evaporator.

The advantages of refrigerant migration are these: no extra components are required in the system, control is performed by the chiller itself, and there are no additional fouling concerns. It is possible for the free cooling chiller to satisfy many cooling load requirements without operating the compressor, especially when the system can accommodate warmer chilled water temperatures at part-load conditions.

period five

Application Considerations

notes

equipment certification standards

ARI Standard 550/590

▲ Purpose

- ◆ Establish definitions, testing, and rating requirements

▲ Scope

- ◆ Factory designed and prefabricated water chillers
- ◆ Vapor-compression refrigeration
- ◆ Air-cooled and water-cooled condensing



Figure 62

Equipment Certification Standards

The Air Conditioning & Refrigeration Institute (ARI) establishes rating standards for packaged HVAC equipment. ARI also certifies and labels equipment through programs that involve random testing of a manufacturer's equipment to verify published performance.

The overall objective of ARI Standard 550/590–1998 is to promote consistent rating and testing methods for all types and sizes of water chillers, with an accurate representation of actual performance. It covers factory-designed, prefabricated water chillers, both air-cooled and water-cooled, using vapor-compression refrigeration. This generally includes chillers with centrifugal, helical-rotary (screw), reciprocating, or scroll compressors.

equipment certification standards

ARI Standard 550/590

▲ Standard rating conditions

- ◆ Common system conditions for published ratings
- ◆ Fouling factor

▲ Integrated Part Load Value (IPLV)

- ◆ Part-load efficiency rating
- ◆ Based on an "average" single-chiller installation
- ◆ Standard operating conditions

Figure 63

The standard rating conditions used for ARI certification represent typical design temperatures and flow rates for which water-cooled and air-cooled systems are designed. They are not suggestions for good design practice for a

period five

Application Considerations

notes

given system—they simply define a common rating point to aid comparisons. Trends toward improved humidity control and energy efficiency have changed some of the actual conditions selected for specific applications.

Impurities in the chilled- and condenser-water systems eventually deposit on evaporator and condenser tube surfaces, impeding heat transfer. Catalogued performance data includes a fouling factor that accounts for this effect to more closely predict actual chiller performance.

ARI's part-load efficiency rating system establishes a single, blended estimate of stand-alone chiller performance. The Integrated Part Load Value (IPLV) predicts chiller efficiency at the ARI standard rating conditions using weighted averages representing a broad range of geographic locations, building types, and operating-hour scenarios, both with and without an air-side economizer. While the weighted averages place greater emphasis on the part-load operation of an average, single-chiller installation, they will not—by definition—represent any particular installation.

Additionally, ARI notes that more than 80 percent of all chillers are installed in multiple-chiller plants. Chillers in these plants exhibit different unloading characteristics than the IPLV weighted formula indicates. Appendix D of the Standard explains this further:

...The [IPLV] equation was derived to provide a representation of the average part-load efficiency for a single chiller only. However, it is best to use a comprehensive analysis that reflects actual weather data, building load characteristics, operational hours, economizer capabilities, and energy drawn by auxiliaries such as pumps and cooling towers, when calculating the chiller and system efficiency. This becomes increasingly important with multiple chiller systems because individual chillers operating within multiple chiller systems are more heavily loaded than single chillers within single chiller systems.

Remember that the ARI rating is a standardized representation. Many chillers do not run at standard rating conditions and few are applied in single-chiller installations. Performing a comprehensive energy analysis is the best method of comparing the system operating cost difference between 2 chillers.

period six **Review**

notes

Centrifugal Water Chillers

period six
Review

Figure 64

Let's review the main concepts that were covered in this clinic on centrifugal water chillers.

Review—Period 1

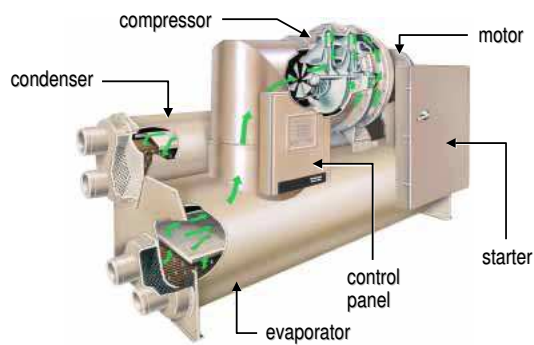

Figure 65

Period 1 introduced the following components of a centrifugal water chiller: compressor, condenser, expansion device, economizer, evaporator, motor, control panel, and starter.

period six

Review

notes

Review—Period 2

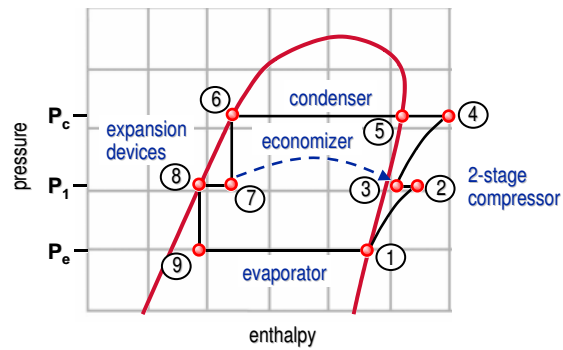

Figure 66

Period 2 described the refrigeration cycle of 2-stage centrifugal water chillers with a pressure-enthalpy chart. The operation of the purge system for low-pressure chillers was also presented.

Review—Period 3

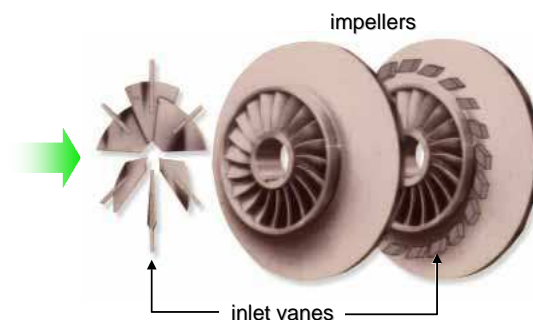

Figure 67

Period 3 further explained the operation of the centrifugal compressor. It described the use of impeller inlet vanes as one method for controlling centrifugal compressor capacity. Surge, multistage compressors, and adjustable-frequency drives were also discussed.

period six

Review

notes

Review—Period 4

▲ Maintenance considerations

- ◆ Operating log
- ◆ Mechanical components
- ◆ Heat-transfer surfaces
- ◆ Fluid analysis

Figure 68

Period 4 described the general maintenance requirements of a centrifugal water chiller, including:

- Recommended data for a daily log
- Required and recommended maintenance for mechanical components
- Recommended maintenance for heat transfer surfaces
- Required analyses for the oil and refrigerant

Review—Period 5

▲ Application considerations

- ◆ Condensing temperature control
- ◆ Constant or variable evaporator-water flow
- ◆ Short evaporator-water loops
- ◆ Heat recovery
- ◆ Free cooling
- ◆ Equipment certification standards

Figure 69

Period 5 presented several considerations in the application of centrifugal water chillers. These included condensing temperature control for water-cooled chillers, constant or variable evaporator-water flow, short evaporator-water loops, heat recovery, free cooling, and equipment certification standards.

period six

Review

notes

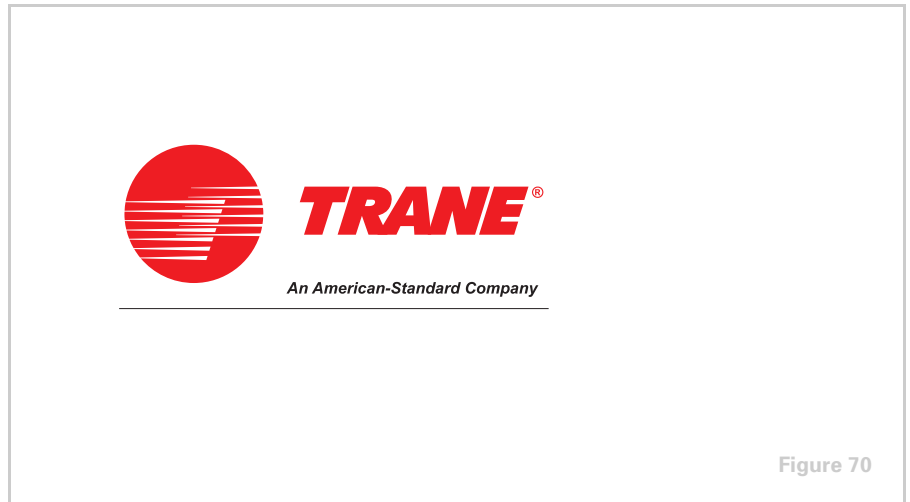

For more information, refer to the following references:

- Trane product catalogs for centrifugal water chiller products (Trane literature order numbers CTV-DS-1 and CTV-DS-2)
- Condensing Water Temperature Control (CTV-EB-84)
- Multiple Chiller System Design and Control (CON-AM-21)
- Principles of Centrifugal Chiller Heat Recovery Operation (AM-REF-2)
- ARI Standard 550/590–1998: Implications For Chilled-Water Plant Design (Trane *Engineers Newsletter*, 1999–volume 28, no. 1)
- Variable-Primary-Flow Systems (Trane *Engineers Newsletter*, 1999–volume 28, no. 3)
- Chilled Water Systems *Engineered Systems Clinics* (CWS-CLC-1, 2, 3, and 4)
- ASHRAE Handbook—Refrigeration
- ASHRAE Handbook—Systems and Equipment

Visit the ASHRAE Bookstore at www.ashrae.org.

For information on additional educational materials available from Trane, contact your local Trane sales office (request a copy of the Educational Materials price sheet — Trane order no. EM-ADV1) or visit our online bookstore at www.trane.com/bookstore/.

Quiz

Questions for Period 1

- 1) A centrifugal compressor converts _____ energy to _____ energy.
- 2) Does the refrigerant velocity increase in the impeller, diffuser passages, or volute of the compressor?
- 3) What is the benefit of using an economizer cycle with a multistage centrifugal compressor?
- 4) What is the difference between a hermetic and an open motor?

Questions for Period 2

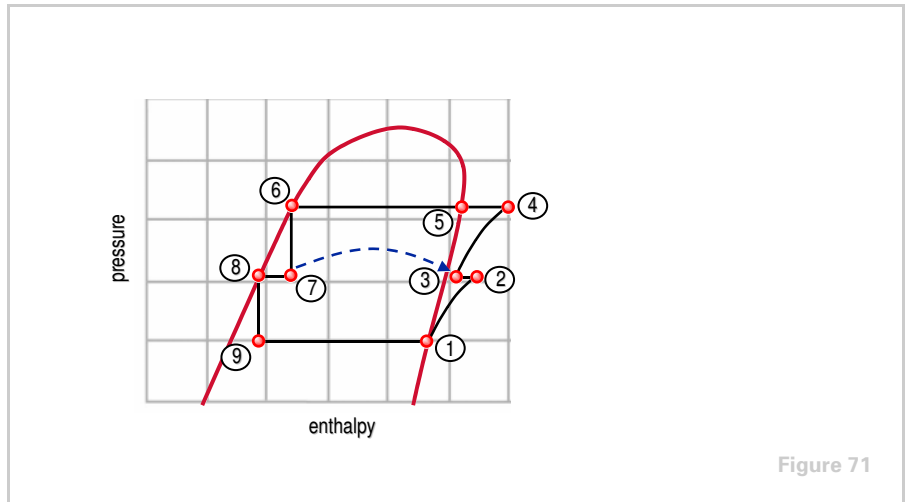

- 5) Using the pressure-enthalpy diagram in Figure 71, identify the following process of the 2-stage centrifugal chiller's refrigeration cycle:
 - a) ① to ②
 - b) ⑦ to ③
 - c) ⑨ to ①
- 6) Air, moisture, and other noncondensable gases are removed from a _____-pressure chiller by what component?

Questions for Period 3

- 7) What velocity component is directly proportional to the refrigerant flow rate through the compressor?

Quiz

- 8)** What velocity component is directly proportional to the impeller's rotational speed times its diameter?
- 9)** What are the 2 most common devices used to vary the capacity of a centrifugal compressor?

Questions for Period 4

- 10)** Explain why proper water treatment is important.

Questions for Period 5

- 11)** The refrigerant migration method of free cooling works because refrigerant migrates from the area of _____ temperature to the area of _____ temperature.
- 12)** What is the purpose of a fouling factor?

Answers

- 1)** kinetic energy to static energy
- 2)** impeller
- 3)** By flashing a portion of the refrigerant prior to entering the evaporator, the economizer reduces the compressor power required since the refrigerant vapor generated in the economizer only needs to be compressed by the higher-stage impeller.
- 4)** A hermetic motor is totally enclosed within the chiller's refrigeration system and the heat it generates is absorbed by liquid refrigerant. An open motor is mounted externally—outside of the chiller's refrigeration system—and uses a coupling to connect the motor and compressor shafts. The heat generated by the open motor is rejected to the air drawn in from the equipment room.
- 5)**
 - a)** first stage of compression or first-stage impeller
 - b)** economizer
 - c)** evaporator
- 6)** low-pressure chiller; purge system
- 7)** radial velocity (V_r)
- 8)** tangential velocity (V_t)
- 9)** inlet vanes and adjustable-frequency (or variable-speed) drive
- 10)** The heat transfer (tube) surfaces inside the chiller must be kept free of scale and sludge to ensure optimum performance. Even a thin deposit of scale can substantially reduce heat transfer capacity.
- 11)** higher; lower
- 12)** It is used to more closely predict actual chiller performance by accounting for the effect of impurities in the chilled- and condenser-water systems. These impurities will eventually deposit on evaporator and condenser tube surfaces, impeding (fouling) heat transfer.

Glossary

adjustable-frequency drive (AFD) A device used to vary the capacity of a centrifugal compressor by varying the speed of the motor that rotates the impeller(s).

air-side economizer A method of free cooling that involves using cooler outdoor air for cooling instead of recirculating warmer indoor air.

ARI Air Conditioning & Refrigeration Institute

ARI Standard 550/590 A publication titled “*Standard for Water Chilling Packages Using the Vapor-Compression Cycle,*” used to promote consistent rating and testing methods for all types and sizes of water chillers. It covers factory-designed, prefabricated water chillers, both air-cooled and water-cooled, using the vapor-compression refrigeration cycle.

ASHRAE American Society of Heating, Refrigerating and Air Conditioning Engineers

ASHRAE Guideline 3 A publication titled “*Reducing Emission of Halogenated Refrigerants in Refrigeration and Air Conditioning Equipment and Systems,*” that includes a recommended list of data points to be logged daily for each water chiller.

compressor The mechanical device used by the chiller to increase the pressure and temperature of the refrigerant vapor.

condenser The region of the chiller where refrigerant vapor is converted to liquid as it rejects heat to water or air.

control panel The microprocessor-based panel that monitors the chiller’s operation, protects it from damage, provides the operator with data and diagnostic messages, and permits interfacing with a building automation system.

diffuser passages Passages inside the centrifugal compressor that start out small and become larger as the refrigerant travels through them. As the size of the diffuser passages increases, the velocity, and therefore the kinetic energy, of the refrigerant decreases. This kinetic energy is converted to static energy or static pressure.

direct-drive motor A type of motor that is connected directly to the compressor shaft, in which the impeller rotates at the same speed as the motor.

direct expansion (DX) shell-and-tube evaporator A type of evaporator where refrigerant flows through the tubes and water fills the surrounding shell.

dynamic compression A method of compression that involves converting energy from one form to another to increase the pressure and temperature of the refrigerant vapor.

Glossary

economizer The component of a multistage centrifugal chiller used to remove vapor from the refrigerant mixture after it passes through an expansion device. This reduces the compressor power required since the refrigerant vapor generated in the economizer only needs to be compressed by the higher-stage impeller(s).

enthalpy The property of a refrigerant indicating its heat content, both sensible and latent.

evaporator The region of the chiller where the system chilled water is continuously cooled by boiling the refrigerant as it picks up heat from the returning system water.

expansion device The component of the chiller used to reduce the pressure and temperature of the refrigerant.

flash The process of liquid refrigerant being vaporized by a sudden reduction of pressure.

flooded shell-and-tube evaporator A type of evaporator where water flows through the tubes and refrigerant fills the surrounding shell.

gear-drive motor A type of motor that transfers its energy to the impeller shaft using a set of gears, allowing the impeller to rotate at a higher speed than the motor.

hermetic motor A type of motor that is totally enclosed within the chiller's refrigeration system and rejects its heat to the liquid refrigerant.

impeller The rotating component of a centrifugal compressor that draws refrigerant vapor into its internal passages and accelerates the refrigerant as it rotates, increasing its velocity and kinetic energy.

inlet vanes A device used to vary the capacity of a centrifugal compressor by "pre-swirling" the refrigerant in the direction of rotation before it enters the impeller, lessening its ability to take in the refrigerant vapor.

loop time The amount of time it takes a particle of water to travel through the chilled water loop.

multistage centrifugal compressor A centrifugal compressor that uses more than 1 impeller to share the task of compressing the refrigerant.

open motor A type of motor that is mounted externally—outside of the chiller's refrigeration system—and uses a coupling to connect the motor and compressor shafts. It rejects its heat to air drawn in from the equipment room.

orifice plate A type of expansion device that uses a fixed plate with holes drilled in it to reduce the pressure and temperature of the refrigerant to the conditions of the evaporator.

Glossary

notes

pressure-enthalpy chart A graphical representation of the saturated properties of a refrigerant, plotting refrigerant pressure versus enthalpy.

purge A device used to remove air, moisture, and other noncondensable gases that may leak into a low-pressure chiller.

refrigerant migration A method of free cooling that allows the chiller to be used as a heat exchanger, without operation of the compressor. It is possible, when the condensing temperature of the refrigerant is low enough, for refrigerant to migrate from the evaporator to the condenser.

refrigeration effect The amount of heat that each pound [kg] of liquid refrigerant will absorb when it evaporates.

starter A device used to connect and disconnect the chiller motor and the electrical distribution system.

surge A condition of unstable compressor operation where the refrigerant alternately flows backward and forward through the compressor impeller, generating noise and vibration.

variable-speed drive See adjustable-frequency drive.

volute A large space around the perimeter of a centrifugal compressor that collects refrigerant vapor after compression.

water-cooled condenser A type of condenser that rejects the heat of the refrigerant to water flowing through it.



TRANE®

The Trane Company
Worldwide Applied Systems Group
3600 Pammel Creek Road
La Crosse, WI 54601-7599
www.trane.com

An American Standard Company

Literature Order Number TRG-TRC010-EN

File Number E/AV-FND-TRG-TRC010-999-EN

Supersedes 2803-10-983

Stocking Location Inland-La Crosse

Since The Trane Company has a policy of continuous product improvement, it reserves the right to change design and specifications without notice.